

# Atlantic States Marine Fisheries Commission

## Sciaenids Management Board

*October 22, 2024*

*8:30 – 11:30 a.m.*

### Draft Agenda

The times listed are approximate; the order in which these items will be taken is subject to change; other items may be added as necessary.

1. Welcome/Call to Order (*D. Haymans*) 8:30 a.m.
2. Board Consent 8:30 a.m.
  - Approval of Agenda
3. Public Comment 8:35 a.m.
4. Consider 2024 Red Drum Benchmark Stock Assessment and Peer Review Report **Action** 8:45 a.m.
  - Presentation of Stock Assessment (*J. Ballenger*)
  - Presentation of Peer Review Panel Report (*G. Fay*)
  - Consider Acceptance of Benchmark Stock Assessment and Peer Review Report for Management Use
  - Consider Management Response, If Necessary (*D. Haymans*)
5. Discuss Risk and Uncertainty Tool Inputs for Red Drum (*K. Drew*) 10:20 a.m.
6. Consider Annual Update to Black Drum Indicators (*H. Rickabaugh*) 11:00 a.m.  
**Possible Action**
7. Consider Black Drum and Spotted Seatrout Fishery Management Plan Reviews and State Compliance for the 2023 Fishing Year (*T. Bauer*) **Action** 11:15 a.m.
8. Other Business/Adjourn 11:30 a.m.

The meeting will be held at The Westin Annapolis (100 Westgate Circle, Annapolis, MD; 888.627.8994) and via webinar; click [here](#) for details

# MEETING OVERVIEW

Sciaenids Management Board  
October 22, 2024  
8:30 a.m. – 11:30 a.m.

Chair: Doug Haymans (GA) Assumed Chairmanship: 02/24	Technical Committee Chairs: Black Drum: Harry Rickabaugh (MD) Atlantic Croaker: Vacant Red Drum: Ethan Simpson (VA) Spot: Harry Rickabaugh (MD)	Law Enforcement Committee Representative: Col. Matthew Rogers (VA)
Vice Chair: Vacant	Advisory Panel Chair: Craig Freeman (VA)	Previous Board Meeting: October 3, 2024
Voting Members: NJ, DE, MD, PRFC, VA, NC, SC, GA, FL, NMFS (10 votes)		

## 2. Board Consent

- Approval of Agenda

**3. Public Comment** – At the beginning of the meeting public comment will be taken on items not on the agenda. Individuals that wish to speak at this time must sign-in at the beginning of the meeting. For agenda items that have already gone out for public hearing and/or have had a public comment period that has closed, the Board Chair may determine that additional public comment will not provide additional information. In this circumstance the Chair will not allow additional public comment on an issue. For agenda items that the public has not had a chance to provide input, the Board Chair may allow limited opportunity for comment. The Board Chair has the discretion to limit the number of speakers and/or the length of each comment.

## 4. Consider 2024 Red Drum Benchmark Stock Assessment and Peer Review Report (8:45-10:20 a.m.)

### Background

- The 2024 red drum benchmark stock assessment evaluated the status of two red drum stocks along the U.S. Atlantic Coast, the northern stock which extends from New Jersey to the North Carolina/South Carolina border and the southern stock which extends from the North Carolina/South Carolina border through the east coast of Florida (**Briefing Materials**).
- The 2024 red drum benchmark stock assessment was completed and peer-reviewed by a panel of independent experts in August 2024. The Peer Review Report provides the panel’s evaluation of the assessment findings (**Briefing Materials**).
- After reviewing the stock assessment, the Board may consider management responses based on the assessment results.

**Presentations**

- Presentation of Stock Assessment Report by J. Ballenger
- Presentation of Peer Review Report by G. Fay

**Board actions for consideration at this meeting**

- Consider acceptance of benchmark stock assessment and peer review report for management use.
- Consider management response, if necessary.

**5. Discuss Risk and Uncertainty Tool Inputs for Red Drum (10:20-11:00 a.m.)****Background**

- The Risk and Uncertainty Decision Tool uses information on stock status, model uncertainty, management uncertainty, ecosystem considerations, and socioeconomic factors to recommend the probability of success that management actions should strive to achieve.
- The recommended probability will be determined by the results of the Red Drum Benchmark Stock Assessment, the technical and socioeconomic inputs, and the Board's final decisions on weightings, all of which will be discussed at this meeting (**Supplemental Materials**).

**Presentations**

- Presentation on the Risk and Uncertainty Tool by K. Drew.

**6. Consider Annual Update to Black Drum Indicators (11:00-11:15 a.m.)****Background**

- Empirical stock indicators were developed as part of the 2023 black drum benchmark stock assessment and were recommended to be monitored annually between stock assessments to detect any concerning trends in the black drum stock.
- For this year's update, the indicators were updated with one additional year of data, 2023.
- The Black Drum Technical Committee (TC) met on October 2 to review the results of the data update to the indicators and make recommendations (**Supplemental Materials**). Overall, the TC did not believe the updated indicator values deviated far enough outside of the historical range to cause concern, though increases in recreational and commercial landings were noted in the South Atlantic. The TC recommends scheduling the next data update to the indicators in 2026, and moving the next scheduled black drum stock assessment from 2027 to 2028.

**Presentations**

- Presentation of Black Drum Indicators Data Update by H. Rickabaugh

**7. Consider Black Drum and Spotted Seatrout Fishery Management Plan Reviews and State Compliance for the 2023 Fishing Year (11:15-11:30 a.m.)****Background**

- Black drum state compliance reports are due on August 1. The Black Drum Plan Review Team (PRT) has reviewed state compliance reports and compiled the annual FMP review. There were no requests by states for *de minimis* status (**Briefing Materials**).

- Spotted Seatrout state compliance reports are due on September 1. The Spotted Seatrout Plan Review Team (PRT) has reviewed state compliance reports and compiled the annual FMP Review. New Jersey and Delaware have requested continued *de minimis* status (**Briefing Materials**).

**Presentations**

- 2023 FMP Reviews for Black Drum and Spotted Seatrout by T. Bauer

**Board actions for consideration at this meeting**

- Consider approval of the 2023 FMP Review and state compliance reports for Black Drum.
- Consider approval of the 2023 FMP Review, state compliance reports, and New Jersey and Delaware's *de minimis* requests for Spotted Seatrout.

**8. Other Business/Adjourn**



## Sciaenids Management Board

**Activity level: High**

**Committee Overlap Score:** Moderate (American Eel TC, Cobia TC, Horseshoe Crab TC, Weakfish TC)

### Committee Task List

- Atlantic Croaker and Spot SAS – Conduct Atlantic Croaker and Spot Benchmark Assessments
- Black Drum TC – Update annual indicators
- Atlantic Croaker TC – Gather data and assist with Atlantic Croaker Benchmark Assessment; Conduct Traffic Light Analysis
- Spot TC – Gather data and assist with Spot Benchmark Assessment; Conduct Traffic Light Analysis
- Atlantic Croaker TC/PRT – July 1: Compliance Reports Due
- Red Drum TC/PRT – July 1: Compliance Reports Due
- Black Drum TC/PRT – August 1: Compliance Reports Due
- Spotted Seatrout PRT – September 1: Compliance Reports Due
- Spot TC/PRT – November 1: Compliance Reports Due

### TC Members:

**Atlantic Croaker:** Kristen Anstead (ASMFC), Tracey Bauer (ASMFC), Stacy VanMorter (NJ), Devon Scott (DE), Harry Rickabaugh (MD), Ingrid Braun (PRFC), Willow Patten (NC), Margaret Finch (SC), Dawn Franco (GA), Halie OFarrell (FL)

**Black Drum:** Harry Rickabaugh (MD, Chair), Jeff Kipp (ASMFC), Tracey Bauer (ASMFC), Jennifer Pyle (NJ), Jordan Zimmerman (DE), Ethan Simpson (VA), Chris Stewart (NC), Chris McDonough (SC), Ryan Harrell (GA), Rebecca Scott (FL)

**Red Drum:** Ethan Simpson (VA, Chair), Jeff Kipp (ASMFC), Tracey Bauer (ASMFC), Alissa Wilson (NJ), Matthew Jargowsky (MD), Cara Kowalchuk (NC, Vice-Chair), Joey Ballenger (SC), Chris Kalinowsky (GA), Sarah Burnsed (FL)

**Spot:** Harry Rickabaugh (MD, Chair), Jeff Kipp (ASMFC), Tracey Bauer (ASMFC), Stacy VanMorter (NJ), Devon Scott (DE), Ingrid Braun (PRFC), Willow Patten (NC), Michelle Willis (SC), Britney Hall (GA), Halie OFarrell (FL)

**Plan Review Team Members:**

**Atlantic Croaker:** Harry Rickabaugh (MD), Ingrid Braun (PRFC), Ethan Simpson (VA), Willow Patten (NC), Chris McDonough (SC), Tracey Bauer (ASMFC)

**Black Drum:** Jordan Zimmerman (DE), Chris Stewart (NC), Chris McDonough (SC), Tracey Bauer (ASMFC)

**Red Drum:** Matthew Jargowsky (MD), Ethan Simpson (VA), Cara Kowalchuk (NC), Joey Ballenger (SC), Matt Kenworthy (FL), Tracey Bauer (ASMFC)

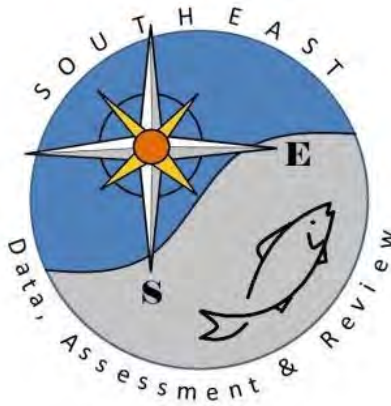
**Spot:** Harry Rickabaugh (MD), Ethan Simpson (VA), Chris McDonough (SC), Dawn Franco (GA), Tracey Bauer (ASMFC)

**Spotted Seatrout:** Tracey Bauer (ASMFC), Samantha MacQuesten (NJ), Lucas Pensinger (NC), Brad Floyd (SC), Chris Kalinowsky (GA)

**SAS Members:**

**Red Drum:** Joey Ballenger (SC, Chair), Jeff Kipp (ASMFC), Tracey Bauer (ASMFC), Angela Giuliano (MD), CJ Schlick (SC), Jared Flowers (GA), Chris Swanson (FL), Ethan Simpson (VA)

**Atlantic Croaker and Spot:** Kristen Anstead (ASMFC), Jeff Kipp (ASMFC), Tracey Bauer (ASMFC), Harry Rickabaugh (MD), Brooke Lowman (VA), Trey Mace (MD), Margaret Finch (SC), CJ Schlick (SC)



# SEDAR

## Southeast Data, Assessment, and Review

---

### SEDAR 93

### Atlantic Red Drum

### Review Workshop Report

**Please note that this peer review report has not yet been reviewed by ASMFC's Red Drum Stock Assessment Subcommittee (SAS) or Technical Committee (TC). The SAS and TC will review this report prior to the meeting to determine if any response is necessary.**

**August 2024**

SEDAR  
4055 Faber Place Drive, Suite 201  
North Charleston, SC 29405

## 1. INTRODUCTION

### 1.1 WORKSHOP TIME AND PLACE

The SEDAR 93 Review Workshop was held in Charleston, SC August 13-16, 2024.

### 1.2 TERMS OF REFERENCE

1. Evaluate responses to Simulation Assessment Peer Review Panel recommendations.
2. Evaluate the thoroughness of data collection and the presentation and treatment of fishery-dependent and fishery-independent data in the assessment, including the following but not limited to:
  - a. Presentation of data source variance (e.g., standard errors).
  - b. Justification for inclusion or elimination of available data sources.
  - c. Consideration of data strengths and weaknesses (e.g., temporal and spatial scale, gear selectivities, ageing accuracy, sample size).
  - d. Calculation and/or standardization of abundance indices.
3. Evaluate the methods and models used to estimate population parameters (e.g., F, abundance) and reference points, including but not limited to:
  - a. If modeling approaches differ from those recommended during the Simulation Assessment, were these differences warranted and appropriate?
  - b. Evaluate the choice and justification of the preferred model(s). Was the most appropriate model (or model averaging approach) chosen given available data and life history of red drum?
  - c. Evaluate model parameterization and specification (e.g., choice of CVs, effective sample sizes, likelihood weighting schemes, calculation/specification of M, stock-recruitment relationship, choice of time-varying parameters, plus group treatment).
4. Evaluate the diagnostic analyses performed, including but not limited to:
  - a. Sensitivity analyses to determine model stability and potential consequences of major model assumptions.
  - b. Retrospective analysis.
5. Evaluate the methods used to characterize uncertainty in estimated parameters. Ensure the implications of uncertainty in technical conclusions are clearly stated.
6. If a minority report has been filed, review minority opinion and associated analyses. If possible, make recommendation on current or future use of alternative assessment approach presented in minority report.

7. Recommend best estimates of stock biomass, abundance, and exploitation from the assessment for use in management, if possible, or specify alternative estimation methods.
8. Evaluate the choice of reference points and the methods used to estimate them. Recommend stock status determination from the assessment, or, if appropriate, specify alternative methods/measures.
9. Review the research, data collection, and assessment methodology recommendations provided by the TC and make any additional recommendations warranted. Clearly prioritize the activities needed to inform and maintain the current assessment, and provide recommendations to improve the reliability of future assessments.
10. Review the recommended timeframe for future assessments provided by the TC and recommend any necessary changes.
11. Prepare a peer review panel terms of reference and advisory report summarizing the panel’s evaluation of the stock assessment and addressing each peer review term of reference. Develop a list of tasks to be completed following the workshop. Complete and submit the report within 4 weeks of workshop conclusion.

*1.3 LIST OF PARTICIPANTS*

***Review Panel***

Gavin Fay (Chair)	University of Massachusetts-Dartmouth
Kotaro Ono	CIE Reviewer
Geoff Tingley	CIE Reviewer
Katyana Vert-Pre	CIE Reviewer

***Analytic Team***

Joey Ballenger	SCDNR
Tracey Bauer	ASMFC
Jared Flowers	GADNR
Angela Giuliano	MDDNR
Jimmy Kilfoil	SCDNR
Jeff Kipp	ASMFC
CJ Schlick	SCDNR

***Staff***

Julie A Neer	SEDAR
Emily Ott	SEDAR
Rachael Silvas	SAFMC Staff

**Workshop Observers**

Chip Collier

SAFMC Staff

**Workshop Observers via Webinar**

Alan Bianchi

NCDNR

Pat Campfield

ASMFC

Manuel Coffill-Rivera

University of South Alabama

Dawn Franco

GADNR

Ryan Harrell

GADNR

Matthew Jargowsky

MDDNR

Chris Kalinowsky

GADNR

Cara Kowalchyk

NCDNR

Laura Lee

USFWS

Rebecca Scott

FLFWCC

**1.4 LIST OF REVIEW WORKSHOP REFERENCE DOCUMENTS**

Document #	Title	Authors
<b>Reference Documents</b>		
SEDAR93-RD01	Red Drum Simulation Assessment and Peer Review Report	Atlantic States Marine Fisheries Commission
SEDAR93-RD02	Estimating the tag-reporting rate and length-based selectivity of red drum ( <i>Sciaenops ocellatus</i> ) in South Carolina using a long-term tag-recapture study	Lukas Ugland Troha
SEDAR93-RD03	Spatial synchrony and temporal dynamics of juvenile red drum <i>Sciaenops ocellatus</i> populations in South Carolina, USA	Stephen A. Arnott, William A Roumillat, John A. Archambault, Charles A. Wenner, Joy I. Gerhard, Tanya L. Darden, Michael R. Denson

**2. REVIEW PANEL REPORT**

The panel report addresses each of the terms of reference.

**1. Evaluate responses to Simulation Assessment Peer Review Panel recommendations.**

Work presented by the SAS in the stock assessment report and during the review workshop to address the Simulation Assessment Peer Review Panel recommendations included:

- a. Revised grid search for deriving reference points for the Traffic Light Analysis (TLA) to only include data available to a TLA model when applied in practice (i.e. pre-2023), and
- b. Further work to demonstrate the southern Stock Synthesis (SS) estimation model (EM) could produce unbiased estimates when fit to data with no observation error.

The revised grid search was used for the basis of optimized TLA reference points in analyses presented in the assessment report.

The SAS presented work to address the performance of the southern (SS) model, with versions of the EM fit to data generated from one iteration of the operating model (OM) with no observation error, both where EM assumptions for growth and  $M$  were the same as in the original simulations (i.e., mis-specified), and when growth and  $M$  were fixed at the operating model true values. Southern EMs fit to data with no observation error showed less relative error in derived quantities for this iteration than in the original simulations, with the relative error of estimate approaching zero as the degree of mis-specification was decreased (Fig. 124, assessment report). Performance was encouraging, though the Panel noted this was only undertaken for a single iteration. Ideally, it would be good to see if the model produces unbiased estimates over multiple scenarios, to ensure the approach is robust to differences in the OM (e.g., recruitment time series). Overall, the Panel agreed this Term of Reference was met.

- 2. Evaluate the thoroughness of data collection and the presentation and treatment of fishery-dependent and fishery-independent data in the assessment, including the following but not limited to:**
  - a. Presentation of data source variance (e.g., standard errors)**
  - b. Justification for inclusion or elimination of available data sources.**
  - c. Consideration of data strengths and weaknesses (e.g., temporal and spatial scale, gear selectivities, aging accuracy, sample size)**
  - d. Calculation and/or standardization of abundance indices**

The presentation of variance in the data sources provided was generally good, with standard error or confidence intervals provided on plotted and tabulated data, where understanding variance was important. Some of the workshop presentation plots did not include variance but this was clarified as necessary.

Multiple data survey sources contributed to indices that would serve as inputs for the southern and northern SS models, TLA, and Skate analysis. The Review Panel was particularly attentive to the standardization processes for survey indices and the spatio-temporal standardization of survey designs. Generally, when an index was excluded, a valid justification was provided. However, the Panel believes improvements can be made in the data and index inclusion/exclusion process. For example, clear analyses were not presented to demonstrate the time series included in the assessment models were all indexing stock abundance and there were no conflicts between time series. The Panel appreciated, and encouraged an emphasis on holistic thinking, particularly to include data that informs different life stages (e.g., recruitment index, subadult index, adult, age/growth for older fish).

Below are the Panel's detailed views on individual indices.

- The historical longline data were excluded due to insufficient coverage and their lack of representativeness for the populations in both the northern and southern models.
- The Panel requested further sensitivity analyses regarding the surveys. In the northern model, the exclusion of the contemporary longline data had little impact, leading to a recommendation to remove it.

- The index of abundance derived from the MRIP CPUE data was excluded from the assessment and was justified due to potential hyperstability. The reasoning for exclusion was reasonable.
- The stopnet survey's geographical scope was limited, with data collected from only one site, raising doubts about its representativeness for the entire coast (i.e., as an index for the stock as a whole). The justification provided was after the fact and did not contradict other sources in the assessment.

Regarding age data, a change in the Florida 183m haul seine survey (1997 to 2022) collection process meant age 0s were absent from marginal age compositions until 2010, which we know does not accurately reflect early age compositions. Based on simulation results and the model's response to excluding the early years, the Panel recommended removing them from the dataset used to generate indices. Conditional age-at-length compositions would not be affected similarly because the non-representation of age 0s in otolith samples was based on size. Small fish were deemed known to be age 0 and not requiring ageing.

The justification provided for excluding scale-based age data was inadequate, as these data may offer valuable insights. There is significant potential for scale age data from younger fish to contribute additional useful information. Moreover, while the SAS showed monthly comparisons as a reason for exclusion, there was insufficient evidence regarding the overall time series, shorter time periods, and spatial coverage.

The use of discard length composition data from angler tag releases was well-reasoned and clearly presented. Incorporating discard length data addressed a significant information gap that would not have been filled otherwise.

The assessment report and presentations during the review workshop documented significant effort by the SAS to describe the available datasets in detail, and was appreciated by the Panel. Many of the data streams are limited geographically and so it was important to understand how representative they may be of stock trends. Some surveys had changes in sampling distribution over their time series. Additional clarification about sampling heterogeneity for adult and subadult surveys was provided by the SAS during the review meeting.

Sample sizes for length composition data were well-described. Decisions on specifications for selectivity of both fishery dependent and fishery independent data were well-reasoned, given the available information, and justified appropriately by the SAS.

Otolith ageing accuracy was reported as high and without significant bias. Scale aging for younger age-classes (e.g., 1 to 3 year olds) was shown to be accurate but was increasingly biased for older fish.

Several surveys showed poor residual diagnostics during CPUE standardization. The standardization models are directly used to create indices of abundance, which were in turn used in all the assessment methods presented during the workshop. The Panel believed the residuals issue should be resolved to ensure reliable indices. This belief was supported during the workshop when the Panel requested and was presented with results of sensitivity analyses on the



southern SS model when using abundance indices derived from CPUE standardization models without any problematic residuals pattern. The test was conducted on the SC trammel net sub-adult index and on the SC longline contemporary adult index. The southern SS model was sensitive to the updated SC trammel sub-adult index. The Panel also noted the residual diagnostics (i.e., qq plots) on the various indices seemed to show a latitudinal pattern.

As a general recommendation for CPUE standardization and subsequent derivation of abundance indices, the Panel noted the importance of doing the following:

1. Proper consideration of changes in the spatio-temporal coverage or sampling design for each survey. This requires including some spatio-temporal effect in the model and/or any available variables to reflect changes.
2. Proper inclusion and treatment of variables that could define red drum “suitable habitat” (i.e., any static (e.g., depth) or dynamic (e.g., temperature, salinity) variables potentially affecting the underlying red drum abundance, as opposed to “catchability” variables that only describe effectiveness in catching red drum. If the habitat variable is dynamic, its effect should be properly included when deriving the abundance index.

Once all of the abundance indices satisfy the above recommendations, the SAS should check to ensure indices are consistent with each other for overlapping age classes/cohorts across surveys, to identify when signals in abundance trends and year class strengths may be different or similar.

3. **Evaluate the methods and models used to estimate population parameters (e.g., F, abundance) and reference points, including but not limited to:**
  - a. **If modeling approaches differ from those recommended during the Simulation Assessment, were these differences warranted and appropriate?**
  - b. **Evaluate the choice and justification of the preferred model(s). Was the most appropriate model (or model averaging approach) chosen given available data and life history of red drum?**
  - c. **Evaluate model parameterization and specification (e.g., choice of CVs, effective sample sizes, likelihood weighting schemes, calculation/specification of M, stock-recruitment relationship, choice of time-varying parameters, plus group treatment).**

During the workshop presentation, the SAS provided a summary table highlighting differences between the SS estimation models (for the northern and southern stocks) used during the Simulation Assessment and the ones used during the current assessment. All except for the choice of steepness value were appropriate. The steepness value was fixed in the SS model for both stocks due to the lack of data to inform estimation of the parameter. However, the analytical team decided to fix its value to 0.99 as opposed to 0.84 (as previously used in the Simulation Assessment based on the literature) and the decision felt arbitrary and ad-hoc. Moreover, the decision, as noted in the report, effectively resulted in there being no stock-recruit relationship in the model. For a strong assumption, such as no stock-recruit relationship, a clear, evidenced justification would need to be provided. A lower fixed value for steepness, as used in the Simulation Assessment, would probably be more appropriate.

Integrated analysis, here using SS, was appropriate given the range of data sources available, and multi-fleet nature of the red drum fisheries. The SS models performed well during simulation. For the southern stock, the developed SS model was the most appropriate method for estimating population parameters and reference points considered in the assessment. For the northern stock, a SS model with satisfactory performance was not able to overcome data deficiencies, although the Panel appreciates the considerable effort by the SAS to develop a working northern SS model. There was nothing to indicate the SS model was not appropriate to formulate. The Traffic Light Analysis (TLA) is an indicator-based approach that was informative across a suite of stock and fishery characteristics. The TLA uses a range of data and thus exhibits a similar spirit to the integrated analysis approach. The TLA was simulation tested and was an appropriate choice by the SAS given the performance of the SS model and the available options.

All 3 methods (SS, TLA and Skate) are reliant on having high quality time series of indices of abundance. The available time series were considered for the SS models, with fewer times series retained than were used in the simulation assessments. The time series exclusions were well justified but inclusions less so. The indices used in the data poor approaches (TLA and Skate) were the same as or similar to those used in the SS models, which was appropriate. However, the data poor methods directly used the recent index data to provide an interpretation of stock health. The SS models used other data to interpret the indices. A more rigorous evaluation of the quality of indices used by the data poor methods was warranted.

#### *Traffic Light Analysis (TLA):*

The rationale for using the TLA was to have a backup to the more quantitative modeling approach. Having a back-up approach to the SS assessment models provided an alternative status evaluation under conditions where an SS model failed to work or where there were concerns about model reliability. The TLA method relied heavily on the specification of a reference period. The TLA reference period appeared somewhat long, and was not well justified. The reference period was also based on previous assessments rather than the durations of available time series. Having an overly-long reference period increases the risk of including times when the stock and fishery were not in a good state. The process of determining optimized values for thresholds from simulations was clear. However, the threshold for the adult abundance indicator was adjusted in what seemed to be an arbitrary way. The rationale for changing the threshold was explained well but the choice of the scalar of 0.5 was not well justified. The reference period for the southern stock (1991-2013) was chosen based on previous assessment results. It would be preferable (and more generalizable) if the reference period could be chosen based on the available time series using robust criteria, rather than past assessment outputs which could be unreliable and/or not available in certain cases. Moreover, the optimized value of thresholds from the Simulation Assessment was arbitrarily adjusted for the adult abundance indicator used in the TLA. The rationale for the change was explained well but the choice of the scalar was not justified.

#### *Stock Synthesis Models:*

In general, the choices made by the SAS when developing the model parameterization and specifications were consistent with the available data and knowledge of the stock(s). Model parameterization and specifications were very well described. Extending the age structure of the estimation models compared to previous assessments allowed the analysts to take advantage of

information on growth of larger fish and relative strength of older year classes. The approach taken to specify, calculate, and estimate time-varying natural mortality, based on a growth-based Lorenzen was well documented and in line with best practices for stocks where  $M$  is believed to vary considerably over lifespan.

A notable change to models from past assessments was the change to fishing year from calendar year. This meant there was a need to make sure all data were shifted accordingly. This was feasible and done for relevant data sources. Choices for specifying time-varying retention in the recreational fishing fleets were aligned with known changes in regulations - a sensible approach that allowed for estimation of changes that influence discards, despite the limited direct information on discard length compositions in the recreational fisheries. Because of the data limitations, the SAS needed to fix some parameters of the selectivity and retention functions to ensure resultant selectivity ogives were consistent and plausible. The parameter choices were well described and reasonable.

Parameterization of the Beverton-Holt stock-recruit relationship was suboptimal. During simulation testing, steepness was an estimated parameter. However, when fit to the available data for the stock the SAS found that steepness was estimated at the upper bound. The SAS decided to fix steepness at the upper bound (1.00). The Panel noted better information for a potential fixed value of steepness was likely available, given that a value based on life-history information was used as the basis for the value in the simulation Operating Model. During the workshop, the Panel requested an additional sensitivity analysis using a fixed value of 0.84.

For the length composition data, the SAS assumed multinomial distributions. They did not consider alternative self-weighting distribution assumptions to the composition data (e.g., dirichlet) that are becoming more commonly applied for these types of models. The decisions for sample size for the length compositions appeared reasonable given available SS diagnostics. In the southern stock SS model, for the subadult surveys, there was some double use of data, by fitting the model to both length compositions and marginal age compositions, which are derived from the same data. The Panel recommended fitting to both length composition data and conditional age-at-length data, or fitting just to marginal age compositions, for a given index. The conditional age-at-length data appeared more robust to changes in sampling protocols over the time series for certain indices.

#### *Skate method:*

The Skate method is an alternative data limited approach, designed to provide a scaler for management action rather than a statement that action is required. Overall, the model parametrization of the Skate method was appropriate, though the method has been shown to perform poorly compared to alternatives (e.g., Legault et al. 2021). The SAS ensured that both key information sources - the abundance index and the catch time series - targeted the same age group, thereby ensuring consistency between the numerator and denominator in terms of unit measurement. The alignment ensured the focus remained on the primary younger segment of the population that was predominantly exploited by the fisheries. Additionally, employing a three-year moving average for both the catch and abundance index was suitable, as it helped emphasize the main trends while mitigating the effects of random fluctuations ("noise"). The reference point used in the Skate method was static and deemed appropriate for this type of

analysis. Nonetheless, the selection of the reference point - currently based on the median of the catch-to-index ratio over the available time series - appears somewhat arbitrary and could significantly influence catch recommendations. Despite the strengths of the data-limited approach, there are several weaknesses that warrant consideration:

- The method is sensitive to variations in year-class strength. As the catch-to-index indicator shifts from strong to weak year classes (or vice versa), there is a risk of overestimating or underestimating the catch advice. No adjustments have been proposed to address such variability.
- Furthermore, the method is susceptible to the "ratcheting" effect on catch advice, as the advice from one application is directly affected by the output of the previous timestep, even when trend indicators do not change. However, the use of a three-year moving average does reduce this impact.

Ideally, the performance of the skate method could have been tested within the simulation framework.

#### *Tagging models:*

A number of tagging models are potentially suitable for use with the available data. The Cormack-Jolly-Seber (CJS) model is a simple model but was appropriate to the data and purpose of the tagging program with respect to red drum. Background details on the main tagging studies used were presented by the SAS, with some key information needed for evaluation of the approach provided via discussion but not in the report. This included information on tag loss (tag shedding). In addition, other required information was discussed in general but the detailed data were not presented or evaluated. This included concerns from the Panel regarding possible gear-specific post-release mortality, with different gear types providing fish for tagging over different periods of the overall tagging program and the potential for undefined bias in the results. The model for survival was based on release age rather than age of fish. A multi-state model would address this. The Panel considered the visualization of annual apparent survival from the CJS analysis to be over-smoothed.

- 4. Evaluate the diagnostic analyses performed, including but not limited to:**
  - a. Sensitivity analyses to determine model stability and potential consequences of major model assumptions.**
  - b. Retrospective analysis.**

#### *Traffic Light Analysis:*

Sensitivity of output to alternative reference points was provided. 11 different reference periods were tested and changes in outputs were examined. However, details about each sensitivity test were not in the report. Sensitivity analysis results were largely in agreement with only the adult abundance, showing some disagreement with 4 cases requiring "moderate action" and 7 "no action" out of the 11 cases tested. Other sensitivity analyses were discussed during the meeting but nothing more was presented nor evaluated. The additional sensitivity analyses included: the use of updated abundance indices based on CPUE standardization without concerning residual patterns; changes in TLA thresholds due to changes in the assumed steepness; and possible inclusion of new scenarios (e.g., hyperstability/bias in the adult longline index) when evaluating

TLA thresholds. There was some opportunity for a historical retrospective for the TLA. However, it would likely be limited by the time series duration of key datasets.

*Stock Synthesis:*

The Stock Synthesis (SS) model diagnostic analyses were conducted in accordance with standard practices for stock synthesis models. The SAS team delivered a comprehensive presentation of the model diagnostics, including assessments of convergence, goodness-of-fit, sources of information and structure, and sensitivity analysis.

For the southern stock, the SAS presented several elements to demonstrate model convergence. Model structure was confirmed to be robust, as no parameters reached their bounds. Additionally, the final gradient was minimal ( $5.76014e-05$ ), with the Hessian matrix positive definite. These factors, along with jitter analysis, indicated the model successfully converged to a global solution. Further validation was provided through the presentation of additional convergence diagnostics, such as the parameter correlation matrix, that supported the convergence conclusions.

Residual analysis was employed, in an appropriate way, to assess the goodness-of-fit across indices of recruitment, sub-adult, adult, and composition data. The Francis plot was utilized to summarize goodness-of-fit to composition data, and deemed an appropriate choice. Although most residuals appeared random, the index residuals plot lacked the three residual standard deviation areas necessary for confirmation. Some residuals displayed biases and skewness, indicative of potential model misspecification. The Panel identified possible sources for these issues, particularly concerning index standardization. It was noted that while diagnostics for index standardization were discussed during presentations, upon request from an earlier meeting, they were not included in the report. Once presented, the indices revealed poor diagnostics, characterized by residual patterns and skewed QQ plot distributions. As mentioned above, the Panel recommended a more comprehensive diagnostic evaluation of residuals during index standardization.

The retrospective analysis of information sources and model structure was thorough, employing a six-year peel to monitor key reference point-related quantities, including spawning stock biomass (SSB), relative SSB, Age-2 fishing mortality, and Spawning Potential Ratio (SPR) estimates. The analysis revealed a minor retrospective pattern, with a three-year peel divergence attributed by the SAS to low 2019 index values, and suggested the indices warrant further scrutiny. Historical retrospective analysis demonstrated the model's performance relative to previous assessments.

A detailed sensitivity analysis was conducted for the SS southern model. The sensitivity of model results to data inclusion/exclusion was explored as part of model building, but not done with the final base model. No bridge runs from previous assessments were presented. The Panel thought this was acceptable given the substantial changes in models and data streams. A comparison of model result quantities to previous assessment estimates was provided, as detailed below. Despite the thoroughness of diagnostics, the Panel suggested including additional diagnostics from the SS cookbook. For instance, the SAS could have considered hindcasting cross-validation for indices, to provide insights on the model's capacity to predict future catches.



*Skate model:*

A sensitivity test based on the choice of terminal year was conducted. Other sensitivity analyses were discussed during the meeting but nothing more was presented nor evaluated. The additional sensitivity analyses included: the choice of the reference period to calculate the reference F value (instead of basing it off to the entire time series); the number of years to calculate the moving average; the use of weighted average; and the use of updated abundance indices based on CPUE standardization without concerning residual patterns. As the skate model was not being proposed as the basis for stock status determination, the Panel did not feel additional analysis here was warranted given the availability of other analyses.

**5. Evaluate the methods used to characterize uncertainty in estimated parameters. Ensure the implications of uncertainty in technical conclusions are clearly stated.***Traffic Light Analysis:*

Uncertainty in outputs was provided based on changes to the reference period. The chosen reference period is relatively long and may include years when the fishery was not performing optimally, which will tend to increase uncertainty. The concern could be reduced by selecting a shorter, well-justified reference period. The Panel suggested further future work to understand the robustness of outputs from the TLA, such as sampling from distributions of the alternative thresholds and number of year error rates.

The TLA uses a simulation framework developed in 2022 to determine the “reference values”. I.e., the threshold values and number of years to trigger management action. Values are based on many iterations and scenarios. In this sense, the determination of “reference values” clearly considers the uncertainty included in the operating model around the TLA inputs, as well as uncertainty around the population dynamics (i.e., different scenarios). Furthermore, the SAS conducted sensitivity analyses on the choice of reference period and determined there was no major change in status for the southern stock. Finally, the SAS utilized precautionary principles when defining the management reference points (i.e., overfishing and overfished) in terms of frequency of any indicator being red. However, the choice of reference points has not been fully evaluated using a simulation or management strategy evaluation approach. The Panel recommended doing so before establishing such reference points.

*Stock Synthesis:*

To characterize uncertainty in the SS model, SAS presented sensitivity analyses, likelihood profiles for  $R_0$ , and asymptotic standard errors, representing good practice. The selection of model elements for sensitivity runs was appropriate, aligning with previous review recommendations. While the sensitivity of model results to data inclusion or exclusion was considered during model development, it was not incorporated into the final base model. Though it was thorough, the Panel observed the sensitivity analysis was missing a test for steepness, set to 0.99, implying no stock-recruitment relationship, despite biological evidence suggesting otherwise. Consequently, during the meeting, the Panel requested an additional analysis with steepness set to 0.84, reflecting the biological analysis. The Panel also requested the following analyses: 1) the impact of removing the first 10 years of age 0 data (2000-2010) from the Florida

haul seine index, 2) the updated standardized South Carolina trammel index, 3) the removal of sub adult (SA) lengths, and 4) the adjustment of MRIP catch estimates combined with a 4% discard mortality, as well as the impact of increasing and decreasing natural mortality by 20%.

Plots of SPR, spawning stock biomass, and relative spawning stock biomass indicated that while most analyses resulted in proportional shifts, only the removal of the Florida haul index data and the update of the South Carolina trammel index led to a change in stock status. The exclusion of sub adult lengths also resulted in a noticeable change in the pattern of SSB and relative SSB estimates. Given these uncertainties, the Panel recommended the datasets be further investigated. The majority of the additional runs led to point estimates that lay within the 95% confidence interval of the proposed base model.

The log-likelihood profiles for R0 revealed the contribution of the total likelihood and of the component likelihood for each datasets. The analysis was done correctly and showed the model was mainly informed by the recruitment deviates, lengths, and discards, as they contributed the strongest to the log-likelihood profile. However, the total log-likelihood seems to be a trade-off between the model trying to fit the age composition data and the index, which highlighted data conflicts between the two sources.

#### *Skate model:*

The SAS appropriately used a moving average in the Skate analysis to focus on changes in trend while reducing the effect of noise. During the review workshop, the Panel also discussed the use of weighted moving average where the weight is based on the variability around the estimated annual index:catch ratio (i.e., inverse variance). The latter was not presented or evaluated during the workshop. Furthermore, the Panel noted an ad hoc characterization of sensitivity of the results to the reference period (including or excluding the 2022 fishing year). Further sensitivity on the choice of reference period (to calculate the “relative F”) was discussed during the meeting but was not presented nor evaluated during the meeting.

While there were no management reference points for the Skate method yet, the Panel recognized the value of performing a simulation analysis or a management strategy evaluation to evaluate the effectiveness of different harvest control rules and/or reference points if the Skate method is to be used to provide quantitative catch advice.

#### *Tagging models:*

Uncertainty in the tagging model estimates were provided using asymptotic standard errors.

### **6. If a minority report has been filed, review minority opinion and any associated analyses. If possible, make recommendation on current or future use of alternative assessment approach presented in minority report.**

No minority report was filed.

**7. Recommend best estimates of stock biomass, abundance, and exploitation from the assessment for use in management, if possible, or specify alternative estimation methods.**

Northern stock: As there was no accepted SS model for the northern stock, either presented or developed during the review workshop, there are no model-derived usable estimates of biomass, abundance, or exploitation available.

However, the Panel believed the SS model should continue to be developed for potential future application to the northern red drum stock. Model development at a future benchmark assessment may be aided by longer time series of key datasets, especially for abundance indices.

The TLA Approach is interesting, though there are issues that need to be addressed, including robustness testing to understand choices:

- Reference period
- Indices reliability
- MSE performance (requires being able to tie TLA results to specific management actions)

The Panel agreed the TLA could be used as a qualitative indicator for northern stock status. This decision is strengthened by the weight of evidence from imperfect information coming from other analyses (increasing F from Skate, SS, etc.).

- We know recruitment is not a problem
- Based on the abundance indices, the adult index does not seem to have an issue overall
- Fishery Performance – we know there is an artifact because of the 2011 year class

For the index re-analyses that were completed, changes in trends are not extreme, but it is possible these could change enough for the value of an individual year's indicators to change.

Southern stock: For the southern stock, the Panel recommended the Stock Synthesis (SS) model be used as the primary basis for providing best estimates of stock biomass, abundance, and exploitation. The base model appears to be adequate, and additional analyses requested during the workshop indicated the model is generally conservative compared to the Traffic Light Analysis (TLA) and the Skate model. Notably, most of the sensitivity analyses requested during the review fell within the confidence interval of the base model and produced similar stock status outcomes.

While the model is currently performing well, the Panel has some reservations regarding certain input data, the index standardization process, and specific sensitivity analyses presented. Therefore, the Panel strongly recommends updating the following elements in the coming year to address concerns: 1) Revise the Index Standardization using the DHARMA package and explore residuals for potential spatio-temporal autocorrelation, 2) Update the catch history incorporating the latest data to improve model, 3) Consider dropping the longline contemporary survey. Addressing these issues will assist in refining the model, leading to more reliable advice for management of Atlantic red drum.



**8. Evaluate the choice of reference points and the methods used to estimate them. Recommend stock status determination from the assessment, or, if appropriate, specify alternative methods/measures.**

Northern stock:

There are a few reference points for SS models that are already established by the fishery management plan. They included F30% and SPR30% as thresholds and F40% and SPR40% as targets. The Fxx% were calculated based on age-2 fish and the level of F that achieved an SPRxx%. The SSBxx% represented the level of SSB associated with a stock fished at SPRxx%. SSB30% was the overfished limit and SSB40% was the target. However, the SSBxx% reference points are new and not yet part of the FMP. The reference points are seemingly acceptable on the basis of previous use for other stocks but have not been specifically evaluated for red drum stocks. The Panel therefore recommended the reference points be evaluated in the future using a simulation framework. That said, the SS3 model for the northern stock did not perform adequately for the basis of providing status advice.

The TLA approach also defined overfishing/overfished reference points based on experts' precautionary judgment. However, not enough information was provided to the Review Panel to fully evaluate their performance. The Panel therefore noted the reference points need to be evaluated in the future using a simulation framework.

Management reference points are not yet defined for the Skate method. However, the Panel recognized the value of performing a simulation analysis or a management strategy evaluation to evaluate the effectiveness of different harvest control rules and/or reference points if the Skate method was to be used to provide quantitative catch advice.

Southern stock:

The southern SS model used the same approach to reference point determination as proposed for the northern SS model, including for fishing intensity (F30% and SPR30% as thresholds and F40% and SPR40% as targets), and for stock size (SSB30% is the overfished limit and SSB40% is the target). The SSB reference point is new. Depending on how the biomass reference point is defined, it can be a function of the stock-recruitment relationship. There was some uncertainty from the presentation as to what quantities were being presented. Plots suggested SSB30% was the SSB at 30% of virgin biomass and not at F30% as suggested in the presentation. These quantities are identical only under the assumption of no stock recruitment relationship with steepness of 0.99.

Considerable effort had gone into including adult survey (longline) index in the assessment, so that stock status could be based on estimation of SSB. The Panel had some reservations on the estimation of SSB that created hesitancy regarding use of the index to derive reference points, because of the previously mentioned challenges as to whether the longline survey is effectively measuring changes in stock abundance of spawning fish. The models were relatively insensitive to the inclusion/exclusion of the longline data.

Reference points were calculated over the period 2019-2021. The Panel suggested it may be more appropriate to base reference points on the most up to date information, and that the SS model provide estimates for more recent windows (e.g., F could be 2020-2022, and SSB could

be 2021-2023). Changes to the years is unlikely to affect the stock status determination but may do so when stock is close to particular thresholds, as demonstrated in some of the uncertainty analyses when fit to revised indices.

**9. Review the research, data collection, and assessment methodology recommendations provided by the TC and make any additional recommendations warranted. Clearly prioritize the activities needed to inform and maintain the current assessment, and provide recommendations to improve the reliability of future assessments.**

The Review Panel generally supported the research recommendations from the TC. However, in the short/medium-term, there are a few additional topics the Panel recommended prioritizing.

*CPUE standardization*

First and foremost, the SAS needs to fix issues with the CPUE standardization as soon as possible. There are obvious problems with some of the CPUE analysis, and all indices of abundance need to be recomputed while making sure the underlying CPUE standardization does not show any residual pattern. Moreover, the SAS needs to make sure the derived indices properly account for the effect of all “habitat” covariates - both static and dynamic variables believed to affect the underlying biomass during the survey period – that are included in the final CPUE standardization model. The SAS then needs to perform a historical retrospective analysis examining changes in the assessment outputs and recommendation for all included models (i.e., SS, TLA, and Skate method).

*Utilize the simulation framework*

Secondly, the Review Panel believed the simulation framework developed in 2022 needs to be further utilized for testing/determining a variety of assessment relevant information, including:

- The determination of all red drum reference points. Instead of using values taken from the literature, the simulation framework can be used to tune in these reference points to the red drum case study. This includes the use of SPR30% and 40% reference points for the SS models, but also the definition of overfishing and overfished status for the TLA.
- A value of information analysis should be conducted to determine the value of each survey data source - both as indices of abundance but also the composition data – in order to prioritize data collection. The SS models had a hard time fitting to the longline survey indices of abundance in general. One can determine how much improvement in bias can be expected if one increases, for example, the age composition sample of the longline survey to its maximum capacity. Similarly, the simulation study could be used to determine whether the use of conditional age-at-length would be more useful than marginal age composition data.

*Tag recapture data*

The Review Panel also recommended the tagging studies be continued but, at the same time, ensure the necessary parameters for estimation of tag models (e.g., tagging mortality) be updated and continually monitored. During discussion, it was shown that the gear types from which tag data came from changed over time. Thus, there is a need to explore possible ‘gear type’ effects in

the CJS tagging model, or possibly conduct a field experiment to confirm differences in tagging mortality by gear type and gear.

#### *Assessment model development*

The Review Panel recommended further development of the assessment model, particularly the SS models. One possible area of exploration was to investigate the utility of seasonal population dynamics models within SS to deal with growth misspecification (i.e., seasonal change in growth) that cannot be overcome via a 'seasons as fleets' approach.

#### *Fishery dynamics and implementation measures*

Conduct research to understand how to implement measures that might come out of the advisory process, including understanding drivers of fishery dynamics, and exploring ways of delivering necessary reductions in F.

### **10. Review the timeframe for future assessments provided by the TC and recommend any necessary changes.**

Having the next Benchmark Assessment in 5 years time is appropriate. Given the identified issues in the SS assessment for the southern stock of red drum, we recommend an update to the SS assessment for the southern stock in 2025. This should incorporate:

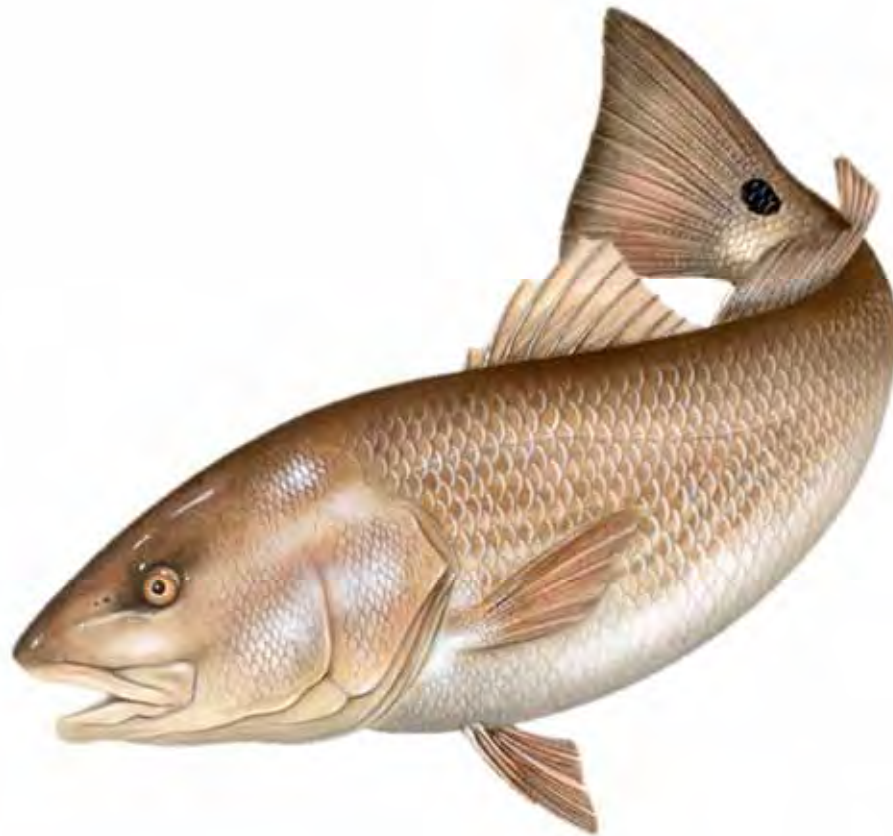
- The most recent data available, including catch, biological, and abundance indices information.
- Updating the model according to Panel recommendations, specifically including the approach to standardization of abundance indices and in the testing and selection of retained abundance indices.
- Expected changes in the catches derived from MRIP, if available.

The Panel recommended updating the TLA in the north in 2025 to incorporate the most up-to-date data. The 2 year update cycle is appropriate.

Consider re-running the southern stock SS assessment within the inter-benchmark period should the expected revision of catch history from MRIP be materially different (~30% reduction) from catches evaluated during the current assessment.

# Atlantic States Marine Fisheries Commission

## *2024 Red Drum Benchmark Stock Assessment Report*



Prepared by the  
ASMFC Red Drum Stock Assessment Subcommittee

And

Approved by the  
ASMFC Red Drum Technical Committee  
June 25, 2024



*Sustainable and Cooperative Management of Atlantic Coastal Fisheries*

**Prepared by the  
Red Drum Stock Assessment Subcommittee**  
Joseph (Joey) C. Ballenger, PhD, SCDNR, Chair  
Tracey Bauer, ASMFC  
Jared Flowers, PhD, GA DNR  
Angela Giuliano, MD DNR  
Jeff Kipp, ASMFC  
C.J. Schlick, PhD, SCDNR  
Ethan Simpson, VMRC  
Chris Swanson, FL FWC

and

**Red Drum Technical Committee**  
Ethan Simpson, VMRC, Chair  
Joseph (Joey) C. Ballenger, PhD, SCDNR  
Tracey Bauer, ASMFC  
Sarah Burnsed, FL FWC  
Matthew Jargowsky, MD DNR  
Chris Kalinowsky, GA DNR  
Jeff Kipp, ASMFC  
Cara Kowalchyk, NC DMF  
Devon Scott, DE REC  
Alissa Wilson, NJ DEP



A publication of the Atlantic States Marine Fisheries Commission pursuant to  
National Oceanic and Atmospheric Administration Award No.  
NA20NMF4740012.

## **ACKNOWLEDGEMENTS**

The Atlantic States Marine Fisheries Commission (ASMFC) thanks all of the individuals who contributed to the development of the 2024 Red Drum Benchmark Stock Assessment. The ASMFC specifically thanks members of the Red Drum Technical Committee (TC) and Red Drum Stock Assessment Subcommittee (SAS) who developed the consensus stock assessment report and ASMFC staff, Jeff Kipp and Tracey Bauer, for coordinating the assessment and completion of the report.

The TC and SAS would also like to acknowledge the following individuals for their support during the assessment: Anna-Mai Christmas-Svajdlenka (ACCSP) for validating and providing commercial landings data from partner agencies and Jimmy Kilfoil (SCDNR) for all his work developing the Cormack-Jolly-Seber tagging model.

## EXECUTIVE SUMMARY

The purpose of this assessment was to evaluate the status of red drum, as divided into two stocks (South Carolina/North Carolina (SC/NC) border north (northern stock) and SC/NC border south through the east coast of Florida (southern stock)), along the U.S. Atlantic Coast. This represents the third benchmark stock assessment of red drum conducted through the Southeast Data Assessment and Review (SEDAR) process, with previous assessments completed in 2009 (SEDAR 18; SEDAR 2009a) and 2015 (SEDAR 44; ASMFC 2017b; SEDAR 2015b). We aligned data sources with a fishing year definition (September 1 – August 31), a change in year definition relative to previous assessments. We calculated recreational dead discards assuming an 8% discard mortality rate, consistent with the previous benchmark and research. We defined the assessment period as 1981-2021, with preliminary fishing year 2022 data included when available, with stock status based on a terminal year of 2021.

### Northern Stock

#### *Removals*

##### Recreational Landings & Discards

The Marine Recreational Information Program (MRIP) provides northern stock recreational landings and discard data for red drum, with landings and discards aggregated for all states from North Carolina north along the Atlantic coast. Recreational removals (harvest + dead discards) exhibited a decrease in the early-1990s, with 3-year average annual removals declining from 0.39 million fish (1986-1988) to 0.12 million fish (1994-1996), before beginning to increase again in the late-1990s. Northern stock recreational removals have exceeded removals observed in the late-1980s since the late-2000s, peaking at 1.06 million fish removed annually from 2011-2013. In the terminal 3-years (2019-2021), annual recreational removals were 0.92 million fish.

The recreational fishery accounts for an increasing proportion of northern stock removals through time, accounting for greater than 90% of annual removals over the last ten years. These removals are increasingly represented by dead discards, averaging 37% of annual recreational removals over the last ten years.

##### Commercial Landings & Discards

The northern stock commercial fishery has two major components, a commercial gill net/beach seine fleet and a commercial other gears fleet. Additional landings data are available from a small-scale North Carolina (NC) recreational commercial gear license (RCGL) program, though these landings represent less than 1% of estimated landings annually. While no coastwide total allowable catch exists, North Carolina commercial landings have been subject to a commercial cap of 250,000 pounds (113.4 mt) since 1991.

Commercial fleet landings have been steady to decreasing, with a high degree of interannual variability, throughout the assessment period. Landings peaked in the late-1990s at a 3-year



average of 144 mt (1997-1999) though a 3-year minimum of 39 mt annually was observed only a few years later (2001-2003). From 2019-2021, annual landings were 78 mt.

Commercial dead discard data derives from an observer program for the North Carolina gill net fishery. Since peaking in the late-1990s (3-year average of 0.10 million fish (1997-1998)), discards have declined, with a 3-year average of 5,625 dead discards from 2019-2022.

### *Indices of Relative Abundance*

#### Recruitment (i.e., Young of the Year (YOY)) Index

The North Carolina Department of Marine Fisheries (NCDMF) bag seine survey, the only northern stock recruitment index, suggests an overall trend of stable to decreasing recruitment outside of the exceptionally strong 1991-, 1993-, and 2018-year classes.

#### Sub-Adult Index

The NCDMF gill net survey, the only northern stock sub-adult index, showed a variable trend over the time series, with the highest value occurring in 2012. The high value in 2012 was driven by the 2011-year class, as the survey primarily encounters age-1 and age-2 red drum.

#### Adult Index

The NCDMF adult red drum longline survey, the only northern stock adult index, indicates adult red drum abundance increased from the late-2000s through the mid- to late-2010s, with interannual variability. Relative abundance in 2019, 2021, and 2022 was lower than observed in other recent years and similar to the abundances observed in the late-2000s and early-2010s.

### *Assessment Models*

#### Stock Synthesis Model

We present two alternative stock synthesis (SS) models developed for the northern stock, with different assumptions regarding fleet selectivity. The “estimated selectivity model” freely estimated selectivity parameters for indices and fishing fleets, though the model proved extremely unstable, estimated unrealistically high recruitment deviations in the 1970s, possessed a narrow dome-shaped recreational selectivity contrary to expert opinion, and produced estimates of low initial fishing mortality (F) and trends in spawning stock biomass (SSB) that did not align with expectations of the history of the fishery through time. The “hybrid selectivity model” attempted to address model stability concerns by fixing the selectivity of the commercial gill net/beach seine and recreational fleet. This model estimated more realistic recruitment deviations in the 1970s and produced recreational selectivity estimates matching expert opinion, but still estimated low initial F and stock biomass trends that did not align with expectations of the history of the fishery while producing unrealistically low (approaching zero) spawning potential ratios (SPR) and extremely high F estimates.

We recommended not using either model for stock status information, instead using trends in F and SPR from the models as a complementary analysis to other assessment techniques. Both suggested an increasing trend in F and decreasing SPR throughout the assessment period.

#### Traffic Light Analysis Method

The assessment team used a fuzzy traffic light analysis (TLA) method to assess the northern stock using three indicators, recruitment, fishery performance, and adult abundance, using a 1996-2013 reference period. In the terminal year, the recruitment, fishery performance, and adult abundance indicators triggered moderate, moderate, and no action, respectively. Results suggest the northern stock is not experiencing overfishing (fishery performance indicator) nor is it overfished (adult abundance indicator). Multiple years of moderate action fishery performance triggers and an increasing frequency of moderate action recruitment triggers are consistent with increasing exploitation in recent years as suggested by the SS model.

#### Skate Data Limited Control Rule Method

We used the Skate data limited control rule method to produce F information and catch advice using a time series of catch and relative abundance data (NCDMF gill net survey) for the northern stock. The analysis uses a ratio of catch to relative abundance, with ratios exceeding relative F (median ratio over the time series) indicative of unsustainable fishing pressure. The northern stock catch:index ratio has increased throughout the time series, indicative of increasing F, exceeding relative F every year since 2015. Observed catch exceeded recommended catch in six of the past seven years, with an average reduction in catch of 23% needed from 2015-2021.

#### *Stock Status*

The northern stock SS model was not deemed useful for stock status determination. Based on the results of the TLA analysis, the northern stock is not experiencing overfishing and is not overfished though there is uncertainty given TLA results during the mid- to late-2010s are heavily influenced by the 2011 strong year class. All three analyses of the northern stock are suggestive of increasing F throughout the assessment period.

### **Southern Stock**

#### *Removals*

#### Recreational Landings & Discards

MRIP provides southern stock recreational landings and discard data for red drum, with landings and discards separated for South Carolina, Georgia, and Florida owing to differing management of the resource through time. Recreational removals (harvest + dead discards) initially decreased in each state from highs in the early- to mid-1980s. Trends then differ by state. In South Carolina, removals continue to decline through the 1990s, then increased through the 2000s and became stable at higher levels in the 2010s. Removals increased since

the 1980s in both Georgia and Florida, but at a greater rate in Florida. At the state level, removals in the late-2010s were at levels similar to the 1980s in all states, though removals in South Carolina and Florida were slightly lower than recent peaks in the 2020s.

When combined, removals exhibited a rapid decrease in the early-1980s, with 3-year average annual removals declining from 2.30 million fish (1983-1985) to 0.69 million fish (1988-1990). Since, removals have increased with southern stock recreational removals meeting and exceeding early-1980s removals since the early-2010s, peaking at a 3-year average of 2.55 million fish (2016-2018). From 2019-2021, annual removals were 1.66 million fish.

### Commercial Landings & Discards

Southern stock landings were highest during the 1950s, when all southern states made significant contributions to the landings, averaging 204,986 pounds from 1950-1956. Landings then declined to low, stable levels as the fishery contracted spatially to only Florida, averaging 136,333 pounds from 1957-1984. During the mid-1980s commercial fisheries faced tightening restrictions resulting in declining landings and a complete phase out by 1989. During the assessment period, landings are highest in 1981 at just over eighty-seven thousand fish and decline throughout the 1980s until the fishery was closed in 1989.

### *Indices of Relative Abundance*

For the southern stock, state fishery-independent surveys were used to develop ten indices of relative abundance representing red drum recruitment, sub-adult, and adult relative abundance indices. Owing to different selectivity patterns and gears, no indices representing similar life stages were combined into a coastwide index with independent selectivity estimated in the southern stock SS model.

### Recruitment (i.e., Young of the Year (YOY)) Indices

We developed three recruitment indices using data from the South Carolina Department of Natural Resources (SCDNR) rotenone survey, Georgia Department of Natural Resources (GADNR) gill net survey, and Florida Fish and Wildlife Commission (FL FWC) 21.3 m haul seine survey. The rotenone survey indicated above average recruitment in 1986, though a stable to decreasing trend in year class strength through time. The gill net and 21.3 m haul seine surveys overlap temporally, with both exhibiting high interannual variability. The gill net survey suggests the strongest year class occurred in 2021, though above average recruitment was also observed in 2001, 2003, 2008, and 2015. Below average recruitment was observed in 2004, 2010-2011, and 2018. The strongest year class identified by the 21.3 m haul seine occurred in 2012, followed by the 2021-year class; the only other above average year class occurred in 2007.

### Sub-Adult Indices

We developed four sub-adult indices using data from the SCDNR stop net, SCDNR electrofishing, SCDNR trammel net, and FL FWC 183 m haul seine surveys. We dropped the electrofishing survey from the SS model due to data conflicts identified early in the process. The stop net survey varied without trend, while the trammel net and 183 m haul seine surveys suggested similar, declining trends over the period of temporal overlap. The trammel net survey suggests a rapid decline in sub-adult abundance from the early-1990s through 1999, followed by higher abundances from 2000-2005. Since 2005, abundance decreased to an all-time low in 2019, followed by a recent marginal increase. Similarly, the 183 m haul seine survey suggests higher relative abundances in 2001-2005 and 2009-2010 (seen in trammel net survey also) within a decreasing trend through the late-2010s.

### Adult Indices

We developed three adult indices using data from the SCDNR historic adult red drum and shark longline, the SCDNR contemporary adult red drum and shark longline, and the GADNR longline surveys. We dropped both the historic longline and GADNR longline survey from the SS model due to data conflicts and poor model diagnostics, though the GADNR longline survey remained a component of the adult abundance indicator used in the TLA. The contemporary longline survey suggested stable to decreasing adult abundance, with low abundances in 2010-2011 and 2021-2022; 2009 was the only year with above average abundance.

### *Assessment Models*

#### Stock Synthesis Model

Recruitment deviations show random variation around time series average recruitment, though positive deviations in the 2010s were smaller than observed in earlier decades indicating reduced recruitment in recent years. The largest recruitment deviation of the assessment period was predicted for the 2022-year class, which had yet to recruit to fisheries.

Population numbers increased through the 1980s and early-1990s, fluctuated at variable but higher levels through the late-1990s and 2000s, before declining since 2010. Pulses of temporary abundance increases are notable in the early-1990s, early-2000s, and late-2000s.

Florida exhibited the highest F levels of the three fishing fleets, followed by South Carolina and Georgia. All fleets suggest increasing F since the 2000s with annual F peaking at or above early-1980s levels near the terminal year. Summary F, characterized by age-2 F, peaked in the early- to mid-1980s, decreased sharply in the late-1980s, and has followed an increasing trend through the late-2010s. Age-2 F decreased slightly in the last few years of the assessment, but remains elevated relative to the late-1980s through early-2010s.

High F led to SPRs below the management threshold of SPR30% in the early-1980s. SPR then increases above the threshold (and target of SPR40%) in the late-1980s, followed by a declining trend that falls below the threshold again in 2013. SPRs remain below the threshold for the remainder of the time series with a terminal three-year average SPR of 0.207.

We used SSB as the measure of reproductive output used to assess overfished conditions. SSB was low (<1,800 mt) through 1988, before gradually increasing through the mid- to late-2000s when SSB reached >10,500 mt. SSB began declining around 2010 with a terminal year SSB of 4,919 mt, the lowest estimate since 1991. Relative to SSB threshold (9,917 mt), SSB was well below the threshold at the start of the time series, first exceeding it in 1993. SSB then remained above the threshold through 2018, though it has continued a declining trend below since with a terminal 3-year average SSB of 8,737 mt (relative to threshold = 0.881).

Reference points for the model include F30%, SPR30% and SSB30% as thresholds and F40%, SPR40% and SSB40% as targets, where F30% and SPR30% denote overfishing and are established in the fishery management plan (FMP; ASMFC 2002). The Fxx% benchmarks are in terms of age-2 fish and is the level of F that achieves an SPRxx%. The SSB30% reference point represents the level of SSB associated with a stock fished at SPR30% and denotes overfished conditions. Stock status determinations are based on terminal three-year (2019-2021) averages of these reference points, using terminal life history characteristics, selectivity, and fleet-specific relative F.

Terminal Age-2 F (0.509) was above the F threshold (0.396) and F target (0.301), while SPR (0.207) was below SPR threshold (0.300) and SPR target (0.400). In addition, the stock is below the SSB target (13,250 mt) and SSB threshold (9,917 mt) with a terminal SSB of 8,737 mt. The southern stock of red drum stock status is overfished and experiencing overfishing.

#### Traffic Light Analysis Method

A southern stock TLA analysis used three indicators (recruitment, fishery performance, and adult abundance) relative to a 1991-2013 reference period. In the terminal year, the recruitment, fishery performance and adult abundance indicators triggered elevated, elevated and moderate actions, respectively. The elevated fishery performance and marginal adult abundance actions indicates the stock was experiencing overfishing but not overfished in the terminal year. However, given the difficulty of triggering the adult abundance indicator, we identified three additional TLA concerning trends in the stock that we recommended would trigger management action. All three were triggered, indicative of consistent below average recruitment, increasing catch and/or decreasing sub-adult abundance, and concerns regarding future adult abundance.

#### Skate Data Limited Control Rule Method

For the southern stock, we used two different catch:index ratios in our Skate analysis, one using SC recreational catch divided by a modified age-2 and -3 trammel net index and the other using FL recreational catch divided by the 183 m haul seine index. Both indicated the catch:index ratio has increased above relative F, exceeding relative F since 2010 and 2013 using the SC and FL data, respectively. This is indicative of increasing F, with observed catch exceeding recommended catch since 2010 and 2013 in SC and FL, respectively. Since 2012 (SC) and 2015 (FL), the Skate method suggests an average reduction of 66.9% and 47.6% of catch relative to the previous year would have been needed.

### Cormack-Jolly-Seber Tag-Recapture Model

We used a Cormack-Jolly-Seber tag-recapture model to estimate apparent survival using SCDNR tag-recapture data from the months of September-December annually. Apparent survival ( $\phi$ ) suggested decreasing mortality (age-1, age-2, & age-3+) through the 1990s to the early-2000s, followed by increasing mortality through the terminal year. If rates of age-specific emigration and natural mortality are assumed constant through time, changes in  $\phi$  are attributed to changing  $F$ , with  $F$  increasing since lows in the mid-2000s with terminal year  $\phi$  lower than observed in the early-1990s.

### *Stock Status*

We based our stock status determination for the southern stock on our SS base model, with a terminal year status of overfished and experiencing overfishing as terminal year 3-year average SPR and SSB were below management benchmarks. Overfishing has been occurring since 2014 while the stock was first determined to be overfished in 2020. The overfishing stock status determination is corroborated by the TLA analysis with increased exploitation of the stock since the late-2000s suggested by both the Skate method and Cormack-Jolly-Seber model.

## TABLE OF CONTENTS

TERMS OF REFERENCE .....	37
1 INTRODUCTION .....	44
1.1 Management Unit Definition .....	44
1.2 Regulatory and Management History .....	44
1.3 Assessment History .....	46
1.3.1 Regional Stock Assessments .....	46
1.3.2 Simulation Assessment .....	50
1.3.3 State Stock Assessments .....	54
1.3.4 Year Definition for Stock Assessment .....	56
2 LIFE HISTORY .....	57
2.1 Stock Definitions .....	57
2.2 Migration Patterns .....	59
2.3 Age and Growth .....	61
2.3.1 Maximum Age .....	62
2.3.2 Growth .....	62
2.4 Reproduction .....	64
2.4.1 Spawning Seasonality .....	64
2.4.2 Sexual Maturity .....	64
2.4.3 Sex ratio .....	66
2.4.4 Spawning Frequencies .....	66
2.4.5 Spawning Location .....	66
2.4.6 Batch Fecundity .....	67
2.4.7 Recruitment Drivers .....	67
2.5 Natural Mortality .....	69
3 HABITAT DESCRIPTION .....	70
3.1 Spawning, Egg, and Larval Habitat .....	70
3.2 Juvenile and Adult Habitats .....	72
3.3 Fish Habitat of Concern .....	75
4 FISHERY-DEPENDENT DATA SOURCES .....	75
4.1 Commercial Data .....	75
4.1.1 Data Collection and Treatment .....	75
4.1.2 Trends .....	82
4.1.3 Potential Biases, Uncertainty, and Measures of Precision .....	84
4.2 Recreational .....	84
4.2.1 Marine Recreational Information Program .....	84
4.2.2 Supplemental Recreational Sampling .....	91
4.3 Tagging Programs .....	95
4.4 Total Fishery Removals .....	100
5 FISHERY-INDEPENDENT DATA SOURCES .....	101
5.1 North Carolina Bag Seine Survey (NC_BagSeine) .....	101
5.1.1 Data Collection and Treatment .....	101
5.1.2 Trends .....	102
5.1.3 Potential Biases, Uncertainty, and Measures of Precision .....	102

5.2 North Carolina Independent Gill Net Surveys (NC_GillNet).....	102
5.2.1 Data Collection and Treatment.....	102
5.2.2 Trends.....	104
5.2.3 Potential Biases, Uncertainty, and Measures of Precision.....	104
5.3 North Carolina Adult Longline Survey (NC_Longline) .....	104
5.3.1 Data Collection and Treatment.....	104
5.3.2 Trends.....	106
5.3.3 Potential Biases, Uncertainty, and Measures of Precision.....	106
5.4 South Carolina Rotenone Survey (SC_Rotenone) .....	106
5.4.1 Data Collection and Treatment.....	106
5.4.2 Trends.....	108
5.4.3 Potential Biases, Uncertainty, and Measures of Precision.....	108
5.5 South Carolina Stop Net Survey (SC_StopNet) .....	109
5.5.1 Data Collection and Treatment.....	109
5.5.2 Trends.....	111
5.5.3 Potential Biases, Uncertainty, and Measures of Precision.....	112
5.6 South Carolina Trammel Net Survey (SC_Trammel) .....	112
5.6.1 Data Collection and Treatment.....	112
5.6.2 Trends.....	116
5.6.3 Potential Biases, Uncertainty, and Measures of Precision.....	116
5.7 South Carolina Historic Longline Survey (SC_Longline_historic).....	117
5.7.1 Data Collection and Treatment.....	117
5.7.2 Trends.....	119
5.7.3 Potential Biases, Uncertainty, and Measures of Precision.....	119
5.8 South Carolina Electrofishing Survey (SC_Electro) .....	119
5.8.1 Data Collection and Treatment.....	119
5.8.2 Trends.....	123
5.8.3 Potential Biases, Uncertainty, and Measures of Precision.....	123
5.9 South Carolina Contemporary Longline Survey (SC_Longline_contemporary).....	123
5.9.1 Data Collection and Treatment.....	123
5.9.2 Trends.....	127
5.9.3 Potential Biases, Uncertainty, and Measures of Precision.....	127
5.10 Georgia Gill Net Survey (GA_GillNet) .....	128
5.10.1 Data Collection and Treatment.....	128
5.10.2 Trends.....	130
5.10.3 Potential Biases, Uncertainty, and Measures of Precision.....	130
5.11 Georgia Longline Survey (GA_Longline) .....	130
5.11.1 Data Collection and Treatment.....	130
5.11.2 Trends.....	132
5.11.3 Potential Biases, Uncertainty, and Measures of Precision.....	132
5.12 Florida 21.3 Meter Haul Seine Survey (FL_21.3_HaulSeine).....	133
5.12.1 Data Collection and Treatment.....	133
5.12.2 Trends.....	134
5.12.3 Potential Biases, Uncertainty, and Measures of Precision.....	134



5.13 Florida 183 Meter Haul Seine Survey (FL_183_HaulSeine).....	134
5.13.1 Data Collection and Treatment.....	134
5.13.2 Trends.....	136
5.13.3 Potential Biases, Uncertainty, and Measures of Precision.....	136
6 METHODS.....	136
6.1 Cormack-Jolly-Seber Tagging Model .....	136
6.1.1 Background.....	136
6.1.2 Data .....	137
6.1.3 Model specification and selection .....	138
6.1.4 Results .....	138
6.2 Stock Synthesis Models .....	139
6.2.1 Background.....	139
6.2.2 Results .....	147
6.3 Traffic Light Analysis.....	157
6.3.1 Background.....	157
6.3.2 Framework and Optimization .....	158
6.3.3 Results .....	160
6.4 Skate Data Limited Control Rule Method .....	161
6.4.1 Background.....	161
6.4.2 Results .....	163
7 STOCK STATUS.....	164
8 FUTURE ASSESSMENTS AND RESEARCH RECOMMENDATIONS.....	166
9 REFERENCES .....	168
10 TABLES .....	183
11 FIGURES .....	259
12 Appendix A: Other data Sources considered.....	431
12.1 Fishery Dependent Data Sources .....	431
12.1.1 Commercial .....	431
12.1.2 Recreational .....	431

## LIST OF TABLES

Table 1.	Red drum regulation timeline by jurisdiction for the northern stock. ....	183
Table 2.	Red drum regulation timeline by jurisdiction for the southern stock. ....	184
Table 3.	Von Bertalanffy growth parameters estimated for red drum captured in North Carolina from north of the White Oak River (North), within and south of the White Oak River (South), and all individuals combined (Pooled). ....	185
Table 4.	Von Bertalanffy growth parameters estimated for red drum captured in North Carolina from within and south of the White Oak River (south), South Carolina (SC), and all individuals combined (Pooled).....	185
Table 5.	Number of ages of red drum sampled by year from the Atlantic coast of the U.S. from 1981 – 2022. ....	186
Table 6.	Number of red drum age samples collected by state within the Atlantic coast of the U.S. from 1981 – 2022. The variable ‘MULTI’ refers to several fishery independent surveys (e.g., ChesMMAP, NEAMAP) whose sampling universe spans multiple states; they operate in the northern stock. ....	187
Table 7.	Number of red drum age samples collected by fishery dependent and fishery independent sources on the Atlantic coast of the U.S. from 1981 – 2022.....	188
Table 8.	Length-at-maturity as estimated using logistic regressions fit to histologically derived maturity status information from South Carolina (SCDNR) and North Carolina (Ross et al. 1995 and NCDMF Study). Total lengths were measured to the nearest mm TL. As dta was only available from one state in each stock (South Carolina = Southern; North Carolina = Northern), these analyses represent maturity ogives for the respective stock. Parameters a and b ( $\pm$ SE) are for the logistic function $\text{Prop. Mat.} = \frac{e^{Z1} + e^Z}{1 + e^{Z1} + e^Z}$ where $Z = a + b \cdot \text{TL}$ . 50% maturity represents the total length where proportion mature equals 0.5 with 95% CI of estimate in parentheses. Also provided are the maturity ogives and 50% maturities as presented in SEDAR 44 for reference. ....	189
Table 9.	Age-at-maturity as estimated using logistic regressions fit to histologically derived maturity status information from South Carolina (SCDNR) and North Carolina (Ross et al. 1995 and NCDMF Study). Ages (in yrs) fit were age to the nearest month, assuming a September 1 birthday. As data was only available from one state in each stock (South Carolina = Southern; North Carolina = Northern), these analyses represent maturity ogives for the respective stock. Parameters a and b ( $\pm$ SE) are for the logistic function $\text{Prop. Mat.} = \frac{e^{Z1} + e^Z}{1 + e^{Z1} + e^Z}$ where $Z = a + b \cdot \text{Age}$ . 50% maturity represents the age where proportion mature equals 0.5 with 95% CI of estimate in parentheses. Also provided are the maturity ogives and 50% maturities as presented in SEDAR 44 for reference. ....	190

Table 10.	Predicted proportion mature by 20 mm TL bin for the southern and northern stock as estimated in SEDAR44 and the current assessment for female red drum.....	191
Table 11.	Predicted proportion mature by age for the southern and northern stock as estimated in SEDAR44 and the current assessment for female red drum. Note, this is proportion mature on a given birthday, which was assumed to be January 1 in SEDAR 44 and September 1 in the current assessment. This, along with the new data, led to a higher percentage of younger age red drum being mature in the current assessment.....	192
Table 12.	Number of actively spawning and mature females observed by SCDNR from mid-August through September and resultant probability of spawning, spawning frequency, and # of spawns assuming a 45-day spawning season for individual fish. Data was analyzed using only females captured in August, in September, and August and September combined...	192
Table 13.	Correlation results for North Carolina Bag Seine Survey recruitment index and favorable wind indices from North Carolina State Climate Office station KHSE. Significant results ( $p$ -value<0.05) are bolded and italicized.....	193
Table 14.	Correlation results for North Carolina Bag Seine Survey recruitment index and sea surface temperature indices from NOAA National Data Buoy Center Stations DSLN7 and 41025. ....	193
Table 15.	Correlation results for southern stock recruitment indices and favorable wind indices from NOAA National Data Buoy Center Stations 41004 (southeast of Charleston) and 41008 (southeast of Savannah). Significant results ( $p$ -value<0.05) are bolded and italicized. ....	193
Table 16.	Natural mortality-at-age, $M(a)$ , or -weight, $M(w)$ , of red drum in the northern ( $t_{max} = 62$ ) and southern ( $t_{max} = 41$ ) stocks. The ‘Mortality-weight’ model ( $M_w$ ) followed Lorenzen (1996). The ‘Length-inverse’ estimates of $M_L$ followed Lorenzen (2022) using the Hamel and Cope (2022) constant $M$ estimate. The ‘Length-inverse’ model scaled the cumulative mortality rate predicted for ages 2 – 62 and ages 2-41 to the longevity-based constant $M$ estimates for the northern and southern stocks, respectively. ....	194
Table 17.	Commercial gear categories developed and used in past red drum SEDAR stock assessments for ACCSP gear codes. ....	196
Table 18.	Commercial landings data collection methodology by state. ....	199
Table 19.	GLM estimated discards from the estuarine gill net fishery in North Carolina. ....	200
Table 20.	North Carolina red drum lengths obtained by year and gear from commercial fishery-dependent fish house sampling. ....	201
Table 21.	Number of commercial red drum harvested by gear and year from 1989 to 2022 in North Carolina. ....	202

Table 22.	Recreational commercial gill net landings from North Carolina from 1989 to 2022. ....	203
Table 23.	Florida red drum landings during the 1980s in numbers of fish (Murphy 2009). ....	204
Table 24.	Expanded catch-at-length for the major North Carolina commercial gears from 1989 to 2022. ....	205
Table 25.	Recreational red drum catch estimates (1,000s of fish) for the northern stock from MRIP. **2022 data are preliminary. ....	209
Table 26.	Recreational red drum catch estimates (1,000s of fish) for the southern stock from MRIP. **2022 data are preliminary. ....	210
Table 27.	Fishery-dependent biological samples collected via the SCDNR freezer, tournament, and state finfish surveys. ....	212
Table 28.	MGFTP guidance to anglers for tagging red drum throughout coastal South Carolina. ....	213
Table 29.	Number of recaptures as a function of years-at-large from the SCDNR conventional tagging program. ....	213
Table 30.	Indices of abundance for the northern red drum stock. Indices are scaled to their means and SEs are in terms of log(Index). ....	214
Table 31.	Indices of abundance for the southern red drum stock. Indices are scaled to their means and SEs are in terms of log(Index). ....	215
Table 32.	Fixed stations sampled by year as part of the SCDNR rotenone survey. Collections sites are arranged via estuary, from the South to the North. ....	216
Table 33.	Summary of life history information collected via the SCDNR during fishery-independent and fishery-dependent sampling program efforts. Bold #s represent years or sample sizes. Only sample sizes, by sex and maturity status where indicated, are provided for sex and maturity status. All lengths in mm, all weights in g, and all ages in yrs. Age-Length = ages determined based on length at capture and capture month; Age-Otolith = ages determined by otolith thin section aging techniques. ....	217
Table 34.	Size distribution by month of red drum encountered by the SCDNR rotenone survey. The year is aligned to start with August, the first month in which newly born red drum recruit to the gear in South Carolina. Green shaded cells represent age-0 red drum monthly throughout the year. Note, very few age-1+ red drum (denoted by pink shaded cells) are encountered by this survey, with those individuals only captured during the months of August and July. ....	218
Table 35.	SCDNR rotenone survey standardized index of year class relative abundance. RSE = relative standard error; lower and upper refer to the lower and upper bounds of a 95% CI as estimated using estimated marginal means. CPUE refers to the index on the catch scale; Relative abundance is	

	the index and confidence intervals normalized to the mean index value over all years of the survey.....	219
Table 36.	Fixed stations sampled by year as part of the SCDNR stop net survey. Collections sites are arranged via South Carolina estuary, from the South to the North. Note, year represents calendar year (Jan. 1 – Dec. 31) though the index was developed using fishing years (Sept. 1 – Aug. 31). Gray shaded cells are the years and sites considered for initial index development, prior to subsequent sub-sampling based on availability of other covariate information. ....	220
Table 37.	SCDNR stop net survey standardized index of relative abundance. RSE = relative standard error; lower and upper refer to the lower and upper bounds of a 95% CI as estimated using estimated marginal means. CPUE refers to the index on the catch scale; Relative abundance is the index and confidence intervals normalized to the mean index value over all years of the survey.....	221
Table 38.	Fishing years (and months within years) individual contemporary strata have been sampled as part of the SCDNR trammel net survey since 1990. Shaded cells include the years (and months) included in the development of relative abundance indices for individual species. ....	222
Table 39.	By fishing year, number of trammel net collections made in the contemporary strata. Shown is the total number of collections, including those not deemed suitable for index development but useful for collection of life history samples, and the number of collections retained for index development (in parentheses). ....	224
Table 40.	SCDNR trammel net survey standardized index of relative abundance. RSE = relative standard error; lower and upper refer to the lower and upper bounds of a 95% CI as estimated using estimated marginal means. CPUE refers to the index on the catch scale; Relative abundance is the index and confidence intervals normalized to the mean index value over all years of the survey.....	225
Table 41.	Fixed stations sampled by year as part of the SCDNR historic longline survey that were considered during index development. Collection sites are arranged from inshore to offshore North. Given the seasonal nature of the survey, collections made from August-December in a given calendar year (Year) was used to represent adult red drum abundance during that fishing year (e.g., fishing year = calendar year for survey).....	226
Table 42.	SCDNR historic longline survey standardized index of relative abundance. RSE = relative standard error; lower and upper refer to the lower and upper bounds of a 95% CI as estimated using estimated marginal means. CPUE refers to the index on the catch scale, in this case catch per 120 hooks; Relative abundance is the index and confidence intervals normalized to the mean index value over all years of the survey.....	227

Table 43.	Fishing years (and months within years) individual contemporary strata have been sampled as part of the SCDNR electrofishing survey since 2000. .....	228
Table 44.	By fishing year, number of electrofishing collections made in the contemporary strata.....	229
Table 45.	SCDNR electrofishing survey standardized index of relative abundance. RSE = relative standard error; lower and upper refer to the lower and upper bounds of a 95% CI as estimated using estimated marginal means. CPUE refers to the index on the catch scale, in this case catch per 15 minutes electrofishing; Relative abundance is the index and confidence intervals normalized to the mean index value over all years of the survey. ....	230
Table 46.	By year, number of SCDNR contemporary longline collections made. Shown is the total number of collections, including those not deemed suitable for index development but useful for collection of life history samples, and the number of collections retained for index development (in parentheses) by strata.....	231
Table 47.	SCDNR contemporary longline survey standardized index of relative abundance. RSE = relative standard error; lower and upper refer to the lower and upper bounds of a 95% CI as estimated using estimated marginal means. CPUE refers to the index on the catch scale, in this case catch per 120 hooks; Relative abundance is the index and confidence intervals normalized to the mean index value over all years of the survey. ....	232
Table 48.	Georgia Coastal Longline Survey sampling methodologies. November 2006 – December 2020. ....	233
Table 49.	Model structure of the 25 candidate models used to estimate apparent survival ( $\Phi$ ), and encounter probability ( $p$ ) for red drum tagged and released during fisheries-independent sampling by the South Carolina Department of Natural Resources from 1990-2022. The column 'MODEL' indicates the candidate model structure, including variables of age, time, sampling period, and constant probabilities ( $\sim 1$ ) as potential explanatory factors. NPAR indicates the number of parameters estimated in the corresponding model structure, and DELTA_AIC is the difference between that model's Akaike's information criterion value (AIC) and the lowest AIC value of all the candidate models.....	234
Table 50.	Length-length relationships estimated for red drum.....	235
Table 51.	Life history parameters used in SS models for red drum.....	236
Table 52.	Fishing mortality reference points and status measures for red drum analyses including the Stock Synthesis integrated model (SS), traffic light analysis (TLA), and Skate index-based method.....	236
Table 53.	Biomass and abundance reference points and status measures for red drum analyses including the Stock Synthesis integrated model (SS) and	

	traffic light analysis (TLA). Spawning stock biomass measures are in metric tons. ....	237
Table 54.	Configuration details for fishing fleets in the SS northern stock model.....	237
Table 55.	Configuration details for monitoring surveys in the SS northern stock model. ....	238
Table 56.	Retention block details for fishing fleets in the SS northern stock model. ....	238
Table 57.	Configuration details for fishing fleets in the SS southern stock model.....	239
Table 58.	Configuration details for monitoring surveys in the SS southern stock model. ....	239
Table 59.	Retention block details for fishing fleets in the SS southern stock model. ....	240
Table 60.	Life history and recruitment parameters for the northern stock SS estimated selectivity model.....	241
Table 61.	Fishing fleet initial fishing mortality, selectivity, retention, and discard mortality parameters for the northern stock SS estimated selectivity model. ....	242
Table 62.	Survey catchability coefficient and selectivity parameters for the northern stock SS estimated selectivity model.....	242
Table 63.	Jitter analysis results for the northern stock SS estimated selectivity model. The -LL column shows the change in total negative log-likelihood relative to the base model.....	243
Table 64.	Beginning of fishing year abundance estimates (in 1000s of fish) for the northern stock SS estimated selectivity model.....	244
Table 65.	Female spawning stock biomass estimates for the northern stock SS estimated selectivity model. 95% confidence intervals are based on asymptotic standard errors. ....	245
Table 66.	Age-2 fishing mortality (F) and spawning potential ratio (SPR) estimates for the northern stock SS estimated selectivity model. 95% confidence intervals are based on asymptotic standard errors. ....	246
Table 67.	Life history and recruitment parameters for the southern stock SS base model. ....	247
Table 68.	Fishing mortality parameter estimates for the southern stock SS base model. SC_Recreational, GA_Recreational, and FL_Recreational are fleets 1, 2, and 3, respectively.....	248
Table 69.	Fishing fleet initial fishing mortality, selectivity, retention, and discard mortality parameters for the southern stock SS base model. ....	249
Table 70.	Survey catchability coefficient and selectivity parameters for the southern stock SS base model. ....	250
Table 71.	Jitter analysis results for the southern stock SS model. The -LL column shows the change in total negative log-likelihood relative to the base model. ....	250

Table 72.	Beginning of fishing year abundance estimates (in 1000s of fish) for the southern stock SS base model. ....	251
Table 73.	Female spawning stock biomass estimates for the southern stock SS base model. 95% confidence intervals are based on asymptotic standard errors. ....	252
Table 74.	Age-2 fishing mortality (F) and spawning potential ratio (SPR) estimates for the southern stock SS base model. 95% confidence intervals are based on asymptotic standard errors. ....	253
Table 75.	Input data types for traffic light analysis characteristics selected for the red drum TLA framework and the stock status each characteristic is used to indicate.....	254
Table 76.	Data sources for each traffic light analysis characteristic selected for the red drum TLA framework. ....	254
Table 77.	Threshold values for the northern stock optimized from the grid square method. The estimated threshold for adult abundance, 0.78, was halved to serve as a more conservative metric for the assessment.....	254
Table 78.	Threshold values for the southern stock optimized from the grid square method. The estimated threshold for adult abundance, 0.78, was halved to serve as a more conservative metric for the assessment.....	254
Table 79.	Action results derived from the TLA model for the northern stock. The terminal fishing year used for stock status in the assessment is 2021. ....	255
Table 80.	Action results derived from the TLA model for the southern stock. The terminal fishing year used for stock status in the assessment is 2021. ....	255
Table 81.	Action results for the northern stock based on sensitivity runs evaluating changes in duration of reference period. A total of 8 different scenarios were evaluated. Results including the base reference period are in bold. ....	255
Table 82.	Action results for the southern stock based on sensitivity runs evaluating changes in duration of reference period. A total of 11 different scenarios were evaluated. Results including the base reference period are in bold. ....	255
Table 83.	NCDMF gill net survey red drum index (annual; 3-yr avg), MRIP North Carolina and areas north recreational harvest plus North Carolina commercial harvest (annual; 3-yr avg.), normalized catch:index ratio (CatchIndexnorm,y), recommended catch (CatchIndexnorm,y), and proportion change in catch relative to previous year as estimated using Skate methodology by fishing year. Bolded values indicate years with recommended catch reductions.....	256
Table 84.	SCDNR trammel net age-2 and -3 red drum index (annual; 3-yr avg), MRIP South Carolina recreational harvest (annual; 3-yr avg.), normalized catch:index ratio (CatchIndexnorm,y), recommended catch (CatchIndexnorm,y), and proportion change in catch relative to previous	



year as estimated using Skate methodology by fishing year. Bolded values indicate years with recommended catch reductions..... 257

Table 85.

FL FWRI 183 m haul seine red drum index (annual; 3-yr avg), MRIP Florida recreational harvest (annual; 3-yr avg.), normalized catch:index ratio (CatchIndexnorm,y), recommended catch (CatchIndexnorm,y), and proportion change in catch relative to previous year as estimated using Skate methodology by fishing year. Bolded values indicate years with recommended catch reductions..... 258

## LIST OF FIGURES

Figure 1.	Age frequency of red drum captured north of the White Oak River in North Carolina versus within and south of the White Oak River for ages 3+.....	259
Figure 2.	Fit of the von Bertalanffy age-length model to available biological data for red drum captured north of the White Oak River (black dots) and within or south of the White Oak River (red dots).....	259
Figure 3.	Age frequency of red drum captured in South Carolina and red drum captured south of the White Oak River in North Carolina for ages 3+.....	260
Figure 4.	Fit of Von Bertalanffy age-length model to available biological data for red drum captured in South Carolina (black dots) and red drum captured south of the White Oak River in North Carolina (red dots).....	260
Figure 5.	Cumulative proportion of tag recaptures as a function of straight line distance (km) and time-at-large. Time-at-large is split into 5 groups, 0-1 years (orange), 1-2 years (blue), 2-4 years (dark green), 4-6 years (brown), and 6+ years (light green). Fish were tagged as part of SCDNR’s Marine Gamefish Tagging and fishery-independent tagging programs. ....	261
Figure 6.	Age bias plot depicting the mean difference in scale - otolith derived ages for a given otolith derived age. Provided are the mean difference (symbol), 95% CI (black bars) and range of difference in age determinations (gray bars). Marginal histograms are provided showing the numbers of individuals given a particular age based on otolith (top histogram) and scale (right histogram) reads. ....	262
Figure 7.	Number of red drum age samples collected by stock/region (a.) and by state (b.) on the Atlantic coast of the U.S. from 1981 – 2022.....	263
Figure 8.	Number of red drum age samples collected by fishery dependent and fishery independent sources on the Atlantic coast of the U.S. from 1981 – 2022.....	264
Figure 9.	Scatterplot of the length-at-age by stock/region for red drum collected on the Atlantic coast of the U.S. from 1981 – 2022. ....	264
Figure 10.	Segmented regression on red drum biological mean length-at-age by stock. (a) northern and (b) southern.....	265
Figure 11.	Red drum length-at-age data collected from the northern stock of the Atlantic coast of the U.S. (a) the age-varying <i>K</i> growth model (blue line) as applied to the red drum length-at-age data and (b) the residuals from the model fit to the length-at-age data. ....	266
Figure 12.	Red drum length-at-age data collected from the southern stock of the Atlantic coast of the U.S. (a) the age-varying <i>K</i> growth model (blue line) as applied to the red drum length-at-age data and (b) the residuals from the model fit to the length-at-age data. ....	267

Figure 13.	Best fit length-at-maturity ogives for female (left panels) and male (right panels) red drum from the southern (bottom panels; solid blue line) and northern (upper panels; solid orange line) stocks. Shaded regions represent 95% confidence interval about the ogive. Dashed lines are the maturity ogives presented in SEDAR 44. Red dots are maturity (0 = immature; 1 = mature) of individual fish and gold triangles represent observed proportion mature by 20 mm TL bin.....	268
Figure 14.	Best fit length-at-maturity ogives for female (left panel) and male (right panel) red drum from the southern (solid blue line) and northern (solid orange line) stocks. Shaded regions represent 95% confidence interval about the ogive. Dashed lines are the maturity ogives presented in SEDAR 44. ....	269
Figure 15.	Best fit age-at-maturity ogives for female (left panels) and male (right panels) red drum from the southern (bottom panels; solid blue line) and northern (upper panels; solid orange line) stocks. Shaded regions represent 95% confidence interval about the ogive. Dashed lines are the maturity ogives presented in SEDAR 44. Red dots are maturity (0 = immature; 1 = mature) of individual fish and gold triangles represent observed proportion mature by age bin.....	270
Figure 16.	Best fit age-at-maturity ogives for female (left panel) and male (right panel) red drum from the southern (solid blue line) and northern (solid orange line) stocks. Shaded regions represent 95% confidence interval about the ogive. Dashed lines are the maturity ogives presented in SEDAR 44.....	271
Figure 17.	Batch fecundity estimates of female red drum based on the FWRI data set available from Tampa Bay, FL (orange dots) along with a fitted linear regression model (green line) and 95% confidence intervals (dark shaded region) and 95% prediction intervals (light shaded region) for the range of sizes with positive fecundity estimates (based on the model) and non-zero probability of a female being mature based on the Atlantic southern stock length-at-maturity ogive developed for this assessment. ....	272
Figure 18.	North Carolina Bag Seine Survey recruitment index and seasonal favorable wind index from North Carolina State Climate Office station KHSE.....	273
Figure 19.	South Carolina Trammel Net Survey age-1 index lagged back one year and early September favorable wind index from NOAA National Data Buoy Center Station 41004 southeast of Charleston. ....	273
Figure 20.	Georgia Gill Net Survey age-0 fishing year index and early August favorable wind index from NOAA National Data Buoy Center Station 41008 southeast of Savannah. ....	274
Figure 21.	Northern (green lines) and southern (gold lines) externally derived natural mortality estimates based on stock-specific maximum age and either weight-based M-at-age (dashed lines; Lorenzen 1996) or length-based M-at-age (solid lines; Lorenzen 2022). ....	274

Figure 22.	Estimated red drum discards in numbers based on North Carolina estuarine gill net observer program. ....	275
Figure 23.	Total commercial landings of northern stock red drum by the commercial gill net and beach seine (GNBS) fleet. Confidential data have been removed from the data set. ....	276
Figure 24.	Total commercial landings of northern stock red drum by the commercial other gear fleet. Confidential data have been removed from the data set. ...	276
Figure 25.	Total commercial landings of northern stock red drum. Confidential data have been removed from the data set. ....	277
Figure 26.	Total commercial landings of southern stock red drum. Confidential data have been removed from the data set. ....	277
Figure 27.	Annual length distributions of red drum landed by the North_Commercial_GNBS fleet. ....	278
Figure 28.	Annual length distributions of red drum landed by the North_Commercial_Other fleet. ....	279
Figure 29.	Annual length distributions of red drum discarded by the North_Commercial_GNBS fleet. ....	280
Figure 30.	MRIP recreational catch estimates of red drum from the northern stock. Dead discards are calculated with an assumed 8% discard mortality of releases. **2022 data are preliminary. ....	281
Figure 31.	Proportional standard error of MRIP recreational catch estimates of red drum from the northern stock. **2022 data are preliminary. ....	282
Figure 32.	MRIP recreational catch estimates of red drum from the northern stock with 95% confidence intervals (shaded regions). Dead discards are calculated with an assumed 8% discard mortality of releases and confidence intervals are calculated assuming the same PSEs as for released alive estimates. **2022 data are preliminary. ....	283
Figure 33.	MRIP recreational catch estimates of red drum from the southern stock. Dead discards are calculated with an assumed 8% discard mortality of releases. **2022 data are preliminary. ....	284
Figure 34.	Proportional standard error of MRIP recreational catch estimates of red drum from the southern stock. **2022 data are preliminary. ....	285
Figure 35.	MRIP recreational catch estimates of red drum from southern stock states with 95% confidence intervals (shaded regions). Dead discards are calculated with an assumed 8% discard mortality of releases and confidence intervals are calculated assuming the same PSEs as for released alive estimates. **2022 data are preliminary. ....	286
Figure 36.	MRIP recreational total removal estimates of red drum from the northern stock with 95% confidence intervals (shaded regions). Dead discards are calculated with an assumed 8% discard mortality of releases and	

	confidence intervals are calculated assuming the same PSEs as for released alive estimates. **2022 data are preliminary.....	287
Figure 37.	Proportional standard error of MRIP recreational total removal estimates of red drum from the northern stock (assuming released alive and dead discard PSEs are equal). **2022 data are preliminary.....	287
Figure 38.	MRIP recreational total removal estimates of red drum from the southern stock with 95% confidence intervals (shaded regions). Dead discards are calculated with an assumed 8% discard mortality of releases and confidence intervals are calculated assuming the same PSEs as for released alive estimates. **2022 data are preliminary.....	288
Figure 39.	Proportional standard error of MRIP recreational total removal estimates of red drum from the southern stock (assuming released alive and dead discard PSEs are equal). **2022 data are preliminary.....	288
Figure 40.	Ratios of wave 1 to waves 2-6 MRIP catch estimates from North Carolina for years when wave 1 catch estimates are available. Dashed horizontal lines show medians of annual ratios.....	289
Figure 41.	Ratios of wave 1 to waves 2-6 MRIP catch estimates from Georgia for years when wave 1 catch estimates are available. Dashed horizontal lines show medians of annual ratios. Due to a median of zero for released alive estimates, the harvest ratio ( $\approx 0.04$ ) was used for the released alive estimates and overlaps in this figure.....	290
Figure 42.	Wave 1 recreational catch estimates of red drum from North Carolina provided by MRIP and imputed with ratios of wave 1 to waves 2-6 MRIP catch estimates. ....	291
Figure 43.	Wave 1 recreational catch estimates of red drum from Georgia provided by MRIP and imputed with ratios of wave 1 to waves 2-6 MRIP catch estimates.....	292
Figure 44.	Ratios of wave 1 to waves 2-6 State Finfish Survey catch frequencies from South Carolina. Dashed horizontal lines show medians of annual ratios.....	293
Figure 45.	Wave 1 recreational catch estimates of red drum from South Carolina provided by MRIP and imputed with ratios of wave 1 to waves 2-6 State Finfish Survey catch frequencies. ....	294
Figure 46.	MRIP size composition estimates of recreational red drum harvest from the northern stock. **2022 data are preliminary.....	295
Figure 47.	MRIP size composition estimates of recreational red drum harvest from the northern stock aggregated by regulation periods. **2022 data are preliminary. ....	296
Figure 48.	Number of MRIP primary sampling units that encountered red drum in the northern stock for length measurements (effective) and number of individual red drum measured for length (raw). **2022 data are preliminary. ....	297

Figure 49.	MRIP size composition estimates of recreational red drum harvest from South Carolina in the southern stock. **2022 data are preliminary.....	298
Figure 50.	MRIP size composition estimates of recreational red drum harvest from Georgia in the southern stock. **2022 data are preliminary. ....	299
Figure 51.	MRIP size composition estimates of recreational red drum harvest from Florida in the southern stock. **2022 data are preliminary.....	300
Figure 52.	MRIP size composition estimates of recreational red drum harvest from South Carolina aggregated by regulation periods. **2022 data are preliminary. ....	301
Figure 53.	MRIP size composition estimates of recreational red drum harvest from Georgia aggregated by regulation periods. **2022 data are preliminary. ....	302
Figure 54.	MRIP size composition estimates of recreational red drum harvest from Florida aggregated by regulation periods. **2022 data are preliminary.....	303
Figure 55.	Number of MRIP primary sampling units that encountered red drum in the southern stock for length measurements (effective) and number of individual red drum measured for length (raw). **2022 data are preliminary. ....	304
Figure 56.	Size distributions of red drum tagged by volunteer anglers participating in the North Carolina Fish Tagging Program and Virginia Game Fish Tagging Program. Horizontal dashed lines indicate slot sizes in place in North Carolina and Virginia in recent years. ....	305
Figure 57.	Size distributions of red drum tagged by volunteer anglers and recaptured and subsequently released by anglers participating in the Virginia Game Fish Tagging Program. Horizontal dashed lines indicate slot sizes in place in North Carolina and Virginia in recent years. ....	306
Figure 58.	Size distributions of red drum tagged by volunteer anglers participating in the Virginia Game Fish Tagging Program and of harvested red drum from MRIP estimates for the northern stock. Horizontal dashed lines indicate slot sizes in place in North Carolina and Virginia in recent years.....	307
Figure 59.	Size distributions of red drum tagged by volunteer anglers and recaptured and subsequently released by anglers participating in the South Carolina Marine Game Fish Tagging Program from 1989-2000. Horizontal dashed lines indicate slot size in place in South Carolina in recent years. ....	308
Figure 60.	Size distributions of red drum tagged by volunteer anglers and recaptured and subsequently released by anglers participating in the South Carolina Marine Game Fish Tagging Program from 2011-2021. Horizontal dashed lines indicate slot size in place in South Carolina in recent years. ....	309
Figure 61.	Size distributions of red drum tagged by volunteer anglers participating in the South Carolina Marine Game Fish Tagging Program and of harvested red drum from MRIP estimates for South Carolina from 1989-1992 and	

	2011-2021. Horizontal dashed lines indicate slot sizes in place in South Carolina in recent years. ....	310
Figure 62.	Size distributions of red drum tagged by volunteer anglers and recaptured and subsequently released by anglers participating in the Georgia Cooperative Angler Tagging Project. Horizontal dashed lines indicate slot size in place in Georgia in recent years. ....	311
Figure 63.	Size distributions of red drum tagged by volunteer anglers participating in the Georgia Cooperative Angler Tagging Project and of harvested red drum from MRIP estimates for Georgia from 2018-2021. Horizontal dashed lines indicate slot sizes in place in Georgia. ....	312
Figure 64.	Size distributions of released red drum reported through the iAngler phone application and of harvested red drum from MRIP estimates for Florida. Horizontal dashed lines indicate slot sizes in place in Florida. ....	313
Figure 65.	Reported red drum captured during waves 2-6 (March – December; blue bars) and wave 1 (January – February; orange bars) by anglers participating in the SCDNR SFS. ....	314
Figure 66.	Proportion of red drum released during wave 1 (January – February) and waves 2-6 (March – December) as observed in the SCDNR SFS. Shown are the annual estimates (solid, heavy lines) along with a LOESS smoother of annual estimates with 95% confidence intervals (solid, thin lines with surrounding shaded region). ....	314
Figure 67.	From top to bottom, the tags above are: Stainless steel anchor “shoulder” dart tags and internal anchor “belly” tags with disk wired to streamer. ....	315
Figure 68.	Number of red drum tagged annually in South Carolina by tagging program. ....	315
Figure 69.	Number of red drum recaptured annually originally tagged as part of SCDNR's conventional tagging program. ....	316
Figure 70.	Proportion of recaptures released annually for fish tagged as part of the SCDNR conventional tagging programs. ....	316
Figure 71.	Tag year and recapture year of the >47,800 recaptures of fish tagged as part of the SCDNR conventional tagging program. ....	317
Figure 72.	Total fishery removals of northern stock red drum. Stacked area removals are numbers of fish and stacked line removals are metric tons. ....	317
Figure 73.	Total fishery removals (stacked area) of southern stock red drum. ....	318
Figure 74.	Sampling sites of the North Carolina Bag Seine Survey (NC_BagSeine) ....	318
Figure 75.	North Carolina Bag Seine Survey (NC_BagSeine) relative abundance, standardized to its mean, from 1991-2022. Error bars are $\pm$ one standard error. ....	319
Figure 76.	Map of Pamlico Sound and associated rivers showing the sample strata and locations of individual samples taken in the North Carolina Independent Gill Net Survey (NC_GillNet) from 2001 to 2006. ....	319

Figure 77.	Length compositions of red drum captured during the North Carolina Independent Gill Net Survey (NC_GillNet).....	320
Figure 78.	North Carolina Independent Gill Net Survey (NC_GillNet) relative abundance, standardized to its mean, from 2003-2022. Error bars are $\pm$ one standard error. ....	321
Figure 79.	The random grid system and sample regions used in the North Carolina red drum Longline Survey used from 2007 to 2022. The numeric value in each grid designates it to one of the twelve regions sampled. ....	321
Figure 80.	North Carolina Adult Longline Survey (NC_Longline) relative abundance, standardized to its mean, from 2007-2022. Error bars are $\pm$ one standard error. ....	322
Figure 81.	Length compositions of red drum captured during the North Carolina Adult Longline Survey (NC_Longline). ....	323
Figure 82.	Age distribution of red drum captured during the North Carolina Adult Longline Survey (NC_Longline). ....	324
Figure 83.	Frequency of individuals by year class (cohort) collected in the North Carolina Adult Longline Survey (NC_Longline) from 2007 to 2019. ....	325
Figure 84.	Length distribution, based on calendar year (Jan. 1 – Dec. 31), ageing methodology, and day of year of sampling, of red drum encountered by the SCDNR fishery-independent and fishery-dependent sampling programs. Ages are based on biological age, assuming a September 1 birthday. Note, any fish with age determined using scales have been omitted.....	325
Figure 85.	South Carolina Rotenone Survey (SC_Rotenone) relative abundance, standardized to its mean, from 1986-1993. Error bars are $\pm$ one standard error. ....	326
Figure 86.	Length composition of red drum encountered by the South Carolina Stop Net Survey (SC_StopNet) when pooled across all years. ....	326
Figure 87.	Age composition of red drum encountered by the South Carolina Stop Net Survey (SC_StopNet) when pooled across all years. Age 4 represents an age-4+ group. ....	327
Figure 88.	South Carolina Stop Net Survey (SC_StopNet) relative abundance, standardized to its mean, from 1987-1993. Error bars are $\pm$ one standard error. ....	327
Figure 89.	Annual length compositions developed for the South Carolina Stop Net Survey (SC_StopNet).....	328
Figure 90.	Annual age compositions developed for the South Carolina Stop Net Survey (SC_StopNet). Note, age represents biological age assuming a September 1 birthday and age-4 represents a ‘plus’ group.....	329
Figure 91.	Sampling distribution of the South Carolina Trammel Net Survey (SC_Trammel; red shaded areas), South Carolina Electrofishing Survey	



	(SC_Electro; purple shaded areas) and South Carolina Contemporary Longline Survey (SC_Longline_contemporary; green shaded areas) surveys. Also identified are two additional contemporary fishery-independent finfish surveys that do not regularly encounter red drum, SCDNR's COASTSPAN (gray shaded areas) and estuarine trawl (blue shaded areas) surveys. Identified are the five major South Carolina estuaries, from Port Royal Sound in the south to Winyah Bay in the north. ....	330
Figure 92.	Length composition of red drum encountered by the South Carolina Trammel Net Survey (SC_Trammel) when pooled across all years.....	331
Figure 93.	Age composition of red drum encountered by the South Carolina Trammel Net Survey (SC_Trammel) when pooled across all years. Age 5 represents an age 5+ group.....	331
Figure 94.	South Carolina Trammel Net Survey (SC_Trammel) relative abundance, standardized to its mean, from 1991-2022. Error bars are $\pm$ one standard error. ....	332
Figure 95.	Annual length compositions developed for the South Carolina Trammel Net Survey (SC_Trammel).....	333
Figure 96.	Annual age compositions developed for the South Carolina Trammel Net Survey (SC_Trammel). Note, age represents biological age assuming a September 1 birthday and age-5 represents a 'plus' group.....	334
Figure 97.	Fixed stations sampled as part of the South Carolina Historic Longline Survey (SC_Longline_historic) conducted by the SCDNR from 1994-2006 near Charleston, SC. The five fixed stations considered for index development are outlined by red circles. ....	335
Figure 98.	Length composition of red drum encountered by the South Carolina Historic Longline Survey (SC_Longline_historic) when pooled across all years. ....	336
Figure 99.	South Carolina Historic Longline Survey (SC_Longline_historic) relative abundance, standardized to its mean, from 1994-2006. Error bars are $\pm$ one standard error. ....	336
Figure 100.	Annual length compositions developed for the South Carolina Historic Longline Survey (SC_Longline_historic).....	337
Figure 101.	Length composition of red drum encountered by the South Carolina Electrofishing Survey (SC_Electro) when pooled across all years. ....	338
Figure 102.	Age composition of red drum encountered by the South Carolina Electrofishing Survey (SC_Electro) when pooled across all years. Age 4 represents an age 4+ group.....	338
Figure 103.	South Carolina Electrofishing Survey (SC_Electro) relative abundance, standardized to its mean, from 2001-2022. Error bars are $\pm$ one standard error. ....	339

	Total Length (cm)	
	.....	340
Figure 104.	Annual length compositions developed for the South Carolina Electrofishing Survey (SC_Electro).....	340
Figure 105.	Annual age compositions developed for the South Carolina Electrofishing Survey (SC_Electro). Note, age represents biological age assuming a September 1 birthday and age-4 represents a 'plus' group.....	341
Figure 106.	Length composition of red drum encountered by the South Carolina Contemporary Longline Survey (SC_Longline_contemporary) when pooled across all years. ....	342
Figure 107.	Age composition of red drum encountered by the South Carolina Contemporary Longline Survey (SC_Longline_contemporary) when pooled across all years using either raw, randomly selected aged fish (orange) and the best fit proportional odds logistic regression model (green).....	343
Figure 108.	Year class composition of red drum encountered by the South Carolina Contemporary Longline Survey (SC_Longline_contemporary) when pooled across all years using either raw, randomly selected aged fish (orange) and the best fit proportional odds logistic regression model (green).....	343
Figure 109.	SCDNR South Carolina Contemporary Longline Survey (SC_Longline_contemporary) relative abundance, standardized to its mean, from 2007-2022. Error bars are $\pm$ one standard error. ....	344
Figure 110.	Annual length compositions developed for the South Carolina Contemporary Longline Survey (SC_Longline_contemporary). ....	345
Figure 111.	Annual age compositions developed for the South Carolina Contemporary Longline Survey (SC_Longline_contemporary) using either raw, randomly selected aged fish (orange) and the best fit proportional odds logistic regression model (green). ....	346
Figure 112.	Annual year class compositions developed for the South Carolina Contemporary Longline Survey (SC_Longline_contemporary) using either raw, randomly selected aged fish (orange) and the best fit proportional odds logistic regression model (green).....	347
Figure 113.	Coastal Georgia counties with approximate Wassaw Sound and Altamaha River system sample areas. ....	348
Figure 114.	Sample areas for Altamaha River System. ....	349
Figure 115.	Sample areas for Wassaw Sound.....	350
Figure 116.	Georgia Gill Net Survey (GA_GillNet) relative abundance, standardized to its mean, from 2002-2022. Error bars are $\pm$ one standard error.....	350
Figure 117.	Georgia Longline Survey (GA_Longline) relative abundance, standardized to its mean, from 2006-2022. Error bars are $\pm$ one standard error. ....	351
Figure 118.	Length compositions of red drum captured during the Georgia longline survey (GA_Longline).....	352

Figure 119.	Florida 21.3 Meter Haul Seine Survey (FL_21.3_HaulSeine) relative abundance, standardized to its mean, from 2001-2021. Error bars are $\pm$ one standard error. ....	353
Figure 120.	Florida 183 Meter Haul Seine Survey (FL_183_HaulSeine) relative abundance, standardized to its mean, from 2001-2021. Error bars are $\pm$ one standard error. ....	353
Figure 121.	Length compositions of red drum captured during the Florida 183 Meter Haul Seine Survey (FL_183_HaulSeine). ....	354
Figure 122.	Age distribution of red drum captured during the Florida 183 Meter Haul Seine Survey (FL_183_HaulSeine).....	355
Figure 123.	Annual apparent survival estimates of red drum from a Cormack-Jolly-Seber mark-recapture model developed using conventional tagging data from the South Carolina Department of Natural Resources' fisheries-independent monitoring programs. Data include releases from 1990-2021, with recaptures from 1990-2022. A) Annual apparent survival estimates are a function of red drum age + time. B) Annual apparent survival estimates are a function of red drum age + s(time). ....	356
Figure 124.	Relative error for southern SS EM three-year F ratio estimates (a), mature female number estimates (b), and subadult number estimates (c) from the Base scenario (data with observation error), no observation error data with the Base scenario model (No Obs Error), and no observation error data with the Base scenario and correctly specified growth and natural mortality (No Obs Error TruGrowM). The black dashed line indicates no error. ....	357
Figure 125.	Data time series used in SS estimated selectivity model for the northern stock. ....	358
Figure 126.	Data time series used in SS base model for the southern stock. ....	359
Figure 127.	Observed and estimated catches for the North_Commercial_GNBS fleet for the northern stock SS estimated selectivity model (top) and hybrid selectivity model (bottom). ....	360
Figure 128.	Observed and estimated catches for the North_Commercial_Other fleet for the northern stock SS estimated selectivity model (top) and hybrid selectivity model (bottom). ....	361
Figure 129.	Observed and estimated catches for the North_Recreational fleet for the northern stock SS estimated selectivity model (top) and hybrid selectivity model (bottom). ....	362
Figure 130.	Observed and estimated discards (in 1000's of fish) for the commercial gill net beach seine fleet for the northern stock SS estimated selectivity model (top) and hybrid selectivity model (bottom).....	363

Figure 131.	Observed and estimated discards (in 1000's of fish) for the recreational fleet for the northern stock SS estimated selectivity model (top) and hybrid selectivity model (bottom). .....	364
Figure 132.	Observed and estimated index values for the NC_BagSeine survey for the northern stock SS estimated selectivity model (top) and hybrid selectivity model (bottom). .....	365
Figure 133.	Observed and estimated index values for the NC_GillNet survey for the northern stock SS estimated selectivity model (top) and hybrid selectivity model (bottom). .....	366
Figure 134.	Observed and estimated index values for the NC_Longline survey for the northern stock SS estimated selectivity model (top) and hybrid selectivity model (bottom). .....	367
Figure 135.	Length compositions, aggregated across time by fleet/survey for the northern stock SS estimated selectivity model (left) and hybrid selectivity model (right).....	368
Figure 136.	Annual length compositions for the North_Commercial_GNBS discards for the northern stock SS estimated selectivity model.....	369
Figure 137.	Annual length compositions for the North_Commercial_GNBS harvest for the northern stock SS estimated selectivity model.....	370
Figure 138.	Annual length compositions for the North_Commercial_Other harvest for the northern stock SS estimated selectivity model.....	371
Figure 139.	Annual length compositions for the North_Recreational discards for the northern stock SS estimated selectivity model.....	372
Figure 140.	Annual length compositions for the North_Recreational harvest for the northern stock SS estimated selectivity model.....	373
Figure 141.	Mean age from the conditional age data for the North_Commercial_GNBS fleet for the northern stock SS estimated selectivity model (top) and hybrid selectivity model (bottom). .....	374
Figure 142.	Mean age from the conditional age data for the North_Commercial_Other fleet for the northern stock SS estimated selectivity model (top) and hybrid selectivity model (bottom). .....	375
Figure 143.	Mean age from the conditional age data for the North_Recreational fleet for the northern stock SS estimated selectivity model (top) and hybrid selectivity model (bottom). .....	376
Figure 144.	Mean age from the conditional age data for the NC_GillNet survey for the northern stock SS estimated selectivity model (top) and hybrid selectivity model (bottom). .....	377
Figure 145.	Mean age from the conditional age data for the NC_Longline survey for the northern stock SS estimated selectivity model (top) and hybrid selectivity model (bottom). .....	378

Figure 146.	Estimated length based selectivities for the northern stock SS estimated selectivity model (top) and hybrid selectivity model (bottom). The North_Commercial_GNBS and North_Recreational selectivities are fixed in the hybrid selectivity model. ....	379
Figure 147.	Estimated age based selectivity for the NC_Longline survey with derived age based selectivities for the other fleets for the northern stock SS estimated selectivity model (top) and hybrid selectivity model (bottom).....	380
Figure 148.	Retention estimates, by regulatory period, for the North_Commercial_GNBS fleet for the northern stock SS estimated selectivity model (top) and hybrid selectivity model (bottom).....	381
Figure 149.	Retention estimates, by regulatory period, for the North_Recreational fleet for the northern stock SS estimated selectivity model (top) and hybrid selectivity model (bottom). ....	382
Figure 150.	Recruitment deviations, with 95% confidence intervals from asymptotic standard errors, for the northern stock SS estimated selectivity model (top) and hybrid selectivity model (bottom). ....	383
Figure 151.	Estimated recruitment (in 1000s) for the northern stock SS estimated selectivity model (top) and hybrid selectivity model (bottom). Error bars are 95% confidence intervals based on asymptotic standard errors. ....	384
Figure 152.	Estimated population (in 1000s of fish) for the northern stock SS estimated selectivity model (top) and hybrid selectivity model (bottom).....	385
Figure 153.	Estimated female SSB (metric tons) for the northern stock SS estimated selectivity model (top) and hybrid selectivity model (bottom).....	386
Figure 154.	Total age-2 fishing mortality (F) for the northern stock SS estimated selectivity model (top) and hybrid selectivity model (bottom). Error bars are 95% confidence intervals based on asymptotic standard errors. ....	387
Figure 155.	SPR timeseries for the northern stock SS estimated selectivity model (top) and hybrid selectivity model (bottom). Horizontal line is the SPR target (0.30). ....	388
Figure 156.	Spawning potential ratio estimates for the northern stock from the previous benchmark stock assessment using a custom statistical catch-at-age model (ASMFC 2017; orange) and the current benchmark assessment SS estimated selectivity model (black). Estimates from the previous assessment are for calendar years while estimates in the current assessment are for fishing years.....	389
Figure 157.	F and SPR timeseries for the northern stock SS hybrid and estimated selectivity models, each scaled to their means.....	390
Figure 158.	Observed and estimated catches for the SC_Recreational (top), GA_Recreational (middle), and FL_Recreational (bottom) fleets for the southern stock SS base model. ....	391

Figure 159.	Observed and estimated discards (in 1000's of fish) for the southern stock SS base model.....	392
Figure 160.	Observed and estimated index values for the FL_21.3_HaulSeine (top), SC_Rotenone (middle), and GA_GillNet (bottom) age-0 recruitment surveys for the southern stock SS base model. ....	393
Figure 161.	Observed and estimated index values for the SC_StopNet (top), SC_Trammel (middle), and FL_183_HaulSeine (bottom) sub-adult surveys for the southern stock SS base model. ....	394
Figure 162.	Observed and estimated index values for the adult longline survey for the southern stock SS base model. ....	395
Figure 163.	Length compositions, aggregated across time by fleet/survey for the southern stock SS base model. ....	396
Figure 164.	Annual length compositions for the SC_Recreational fleet retained catch for the southern stock SS base model. ....	397
Figure 165.	Annual length compositions for the GA_Recreational fleet retained catch for the southern stock SS base model. ....	398
Figure 166.	Annual length compositions for the GA_Recreational fleet discards for the southern stock SS base model. ....	399
Figure 167.	Annual length compositions for the FL_Recreational fleet retained catch for the southern stock SS base model. ....	400
Figure 168.	Annual length compositions for the FL_Recreational fleet discards for the southern stock SS base model. ....	401
Figure 169.	Annual length compositions for the SC_StopNet survey for the southern stock SS base model. ....	402
Figure 170.	Annual length compositions for the SC_Trammel survey for the southern stock SS base model. ....	403
Figure 171.	Annual length compositions for the FL_183_HaulSeine survey for the southern stock SS base model. ....	404
Figure 172.	Age compositions, aggregated across time by survey for the southern stock SS base model.....	405
Figure 173.	Annual age compositions for the SC_StopNet (left), SC_Trammel (middle), and FL_183_HaulSeine (right) surveys for the southern stock SS base model. ....	406
Figure 174.	Mean age from the conditional age data for the SC_Recreational (top) and GA_Recreational (bottom) fleets for the southern stock SS base model.....	407
Figure 175.	Mean age from the conditional age data for the FL_Recreational fleet (top) and SC_Longline_contemporary survey (bottom) for the southern stock SS base model. ....	408
Figure 176.	Length based selectivities for the southern stock SS base model. The SC_Longline_contemporary survey selectivity is fixed. ....	409

Figure 177.	Retention estimates, by regulatory period, for the SC_Recreational (top), GA_Recreational (middle), and FL_Recreational (bottom) fleets for the southern stock SS base model. ....	410
Figure 178.	Age based selectivities estimated for the SC_StopNet (top), SC_Trammel (middle), and FL_183_HaulSeine (bottom) surveys for the southern stock SS base model.....	411
Figure 179.	Recruitment deviations, with 95% confidence intervals from asymptotic standard errors, for the southern stock SS base model.....	412
Figure 180.	Estimated recruitment (in 1000s) for the southern stock SS base model. Error bars are 95% confidence intervals based on asymptotic standard errors.....	412
Figure 181.	Estimated population abundance (in 1000s of fish) for the southern stock SS base model.....	413
Figure 182.	Estimated female SSB (metric tons) for the southern stock SS base model. Error bars are 95% confidence intervals based on asymptotic standard errors.....	413
Figure 183.	Estimated female SSB relative to the estimated SSB <sub>30%</sub> threshold for the southern stock SS base model. Error bars are 95% confidence intervals based on asymptotic standard errors.....	414
Figure 184.	Estimated fleet-specific fishing mortality (F) for age-2 fish for the southern stock SS base model. ....	414
Figure 185.	Total age-2 fishing mortality (F) for the southern stock SS base model. Error bars are 95% confidence intervals based on asymptotic standard errors. ....	415
Figure 186.	SPR timeseries for the southern stock SS base model. Horizontal line is the SPR target (0.30).....	415
Figure 187.	Likelihood profile plot for unfished recruitment (R0) parameter (on the log scale) for the southern stock SS model.....	416
Figure 188.	Spawning stock biomass and relative spawning stock biomass estimates from retrospective analysis of southern stock SS model. Black dashed lines are 95% confidence intervals based on asymptotic standard errors for base model estimates.....	417
Figure 189.	Spawning potential ratio and age-2 fishing mortality estimates from retrospective analysis of southern stock SS model. Black dashed lines are 95% confidence intervals based on asymptotic standard errors for base model estimates.....	418
Figure 190.	Spawning potential ratio estimates for the southern red drum stock from the previous benchmark stock assessment using a custom statistical catch-at-age model (ASMFC 2017; orange) and the current benchmark assessment SS base model (black). Dashed lines are 95% confidence intervals based on asymptotic standard errors. Estimates from the	

	previous assessment are for calendar years while estimates in the current assessment are for fishing years.....	419
Figure 191.	Observed and estimated index values for the GA_GillNet (left), SC_Trammel (middle), and FL_183_HaulSeine (right) surveys from the retrospective analysis for the southern stock SS model. ....	420
Figure 192.	Age-2 fishing mortality and spawning potential ratio estimates from sensitivity analysis of southern stock SS model. Black dashed lines are 95% confidence intervals based on asymptotic standard errors for base model estimates. The dotted black horizontal line is the SPR threshold. ....	421
Figure 193.	Relative spawning stock biomass and spawning stock biomass estimates from sensitivity analysis of southern stock SS model. Black dashed lines are 95% confidence intervals based on asymptotic standard errors for base model estimates. The dotted black horizontal line is the relative biomass threshold. ....	422
Figure 194.	Graphical representation of traffic light analysis fuzzy method regression calculations of proportion of color using relative abundance index data. Intersection of red and yellow lines occurs at the lower 95% confidence interval and the intersection of yellow and green lines occurs at the upper 95% confidence interval. Figure adapted from ASMFC (2020). ....	423
Figure 195.	Annual TLA results for each selected characteristic in the northern stock. Threshold values are represented by the solid horizontal line. The color at the threshold is the color determination for that year. ....	424
Figure 196.	Annual TLA results for each selected characteristic in the southern stock. Threshold values are represented by the solid horizontal line. The color at the threshold is the color determination for that year. ....	425
Figure 197.	Normalized catch:index ratio for the northern stock using MRIP data recreational harvest of red drum in North Carolina and states further north + North Carolina commercial harvest and the NCDMF gill net index.....	426
Figure 198.	Time series of observed (solid line) and recommended (dashed line) northern stock catch based on Skate analysis using MRIP data on North Carolina and states further north recreational harvest + North Carolina commercial harvest and the NCDMF gill net index.....	426
Figure 199.	Proportional change in catch ( <b>Catch</b> $\Delta$ ) relative to previous fishing year as estimated for the northern stock using the Skate method. No change is denoted by the dashed line at 0, with a reduction in catch (relative to the previous year) needed when less than 0 and vice versa when above. ....	427
Figure 200.	Normalized catch:index ratio for South Carolina (black line) and Florida (red line) and normalized relative F (black dashed line). South Carolina data used MRIP data on South Carolina recreational harvest and the SCDNR ages-2 and -3 trammel net index. Florida data used MRIP data on Florida recreational harvest and the FL FWRI 183 m haul seine survey. ....	428



Figure 201.	Time series of observed (solid line) and recommended (dashed line) South Carolina catch based on Skate analysis using MRIP data on South Carolina recreational harvest and the SCDNR ages-2 and -3 trammel net index. ....	428
Figure 202.	Proportional change in catch ( <b>Catch</b> $\Delta$ ) relative to previous fishing year as estimated for South Carolina (black line) and Florida (red line) using the Skate method. No change is denoted by the dashed line at 0, with a reduction in catch (relative to the previous year) needed when less than 0 and vice versa when above.....	429
Figure 203.	Time series of observed (solid line) and recommended (dashed line) Florida catch based on Skate analysis using MRIP data on Florida recreational harvest and the FL FWRI 183 m haul seine survey.....	429
Figure 204.	Comparison of scaled mortality estimates/metrics from analyses for the southern red drum stock. ....	430

## TERMS OF REFERENCE

For the 2024 ASMFC Red Drum Benchmark Stock Assessment  
Board Approved February 2023

### *Terms of Reference for the Red Drum Assessment*

1. Evaluate Simulation Assessment Peer Review Panel recommendations for the simulation-based analyses used to guide assessment approaches in this benchmark assessment.

As part of a road map to improve red drum stock assessments, the Red Drum Stock Assessment Subcommittee (SAS) conducted a simulation-based stock assessment (ASMFC 2022) prior to this current benchmark assessment. The goal was to inform selection and application of assessment approaches during this assessment. The simulation assessment was reviewed by a panel of external peer reviewers who included recommendations with their findings on the assessment. A summary of the simulation assessment and peer review is provided in Section 1.3.2 and additional details are provided in ASMFC 2022.

The SAS considered recommendations by the simulation assessment reviewers at the beginning of this benchmark assessment and prioritized two they felt were critical for using the simulation work to inform this assessment. These included (1) determining if the Stock Synthesis (SS) assessment model for the southern red drum stock could produce unbiased estimates while using data without observation error from a simulation operating model and (2) repeating a grid search used to determine reference points for the Traffic Light Analysis (TLA) with only data from the time series anticipated in this benchmark stock assessment.

Work was done within this assessment to address the SS and TLA recommendations and is discussed in Sections 6.2.1 and 6.3, respectively.

2. Provide descriptions of each fishery-dependent and fishery-independent data source.
  - a. Describe calculation and potential standardization of abundance indices.
  - b. Discuss trends and associated estimates of uncertainty (e.g., standard errors).
  - c. Justify inclusion or elimination of available data sources.

Fishery-dependent data sets are described in Section 4. Data sets generated for assessment approaches include fishery removals (landed and discarded dead catch from commercial and recreational fisheries), removals size compositions, and conditional age-at-length. Volunteer angler-based tagging programs and phone applications were used to supplement discard size composition data.

Fishery-independent monitoring surveys conducted by state agencies are described in Section 5. Data sets generated for assessment approaches include indices of abundance, size compositions, age compositions, and conditional age-at-length. Standardized indices of

abundance were generated with model-based approaches (e.g., generalized linear models, GLMs).

Data sets considered in the assessment, but not used for generating inputs to the assessment approaches are described in Appendix A. A notable data change during this assessment and covered in the appendix was the decision to exclude recreational CPUE data sets as measures of abundance due to signs of hyperstability.

3. Develop model(s) used to estimate population parameters (e.g.,  $F$ , abundance) and reference points, and analyze model performance.
  - a. Describe stability of model (e.g., ability to find a stable solution, invert Hessian).
  - b. Justify choice of CVs, effective sample sizes, or likelihood weighting schemes.
  - c. Perform sensitivity analyses for starting parameter values, priors, etc. and conduct other model diagnostics as necessary.
  - d. Clearly and thoroughly explain model strengths and limitations.
  - e. Briefly describe history of model usage, its theory and framework, and document associated peer-reviewed literature.
  - f. If modeling approaches differ from those recommended during the Simulation Assessment, discuss divergence from these recommendations.

Several analyses were developed through the course of this assessment. The primary analyses at the beginning of the assessment were the SS models and TLAs recommended during the simulation assessment. Additionally, a Cormack-Jolly-Seber (CJS) tagging model was developed with South Carolina tagging data. This model was not evaluated during the simulation assessment, but was applied here as a complementary analysis providing mortality trends and to better utilize tag-recapture data available for the assessment, a recommendation of past SASs and review panels. Later in the assessment process as signs of instability persisted in some of the SS models, a data-limited method, Skate, was developed as a backup method in the case that stable SS models could not be developed to provide catch advice. This method also was not evaluated during the simulation assessment, but has been evaluated in a simulation framework for interim use when population dynamics models encounter issues with performance (NEFSC 2020). Development of these methods are described in Sections 6.1 (CJS model), 6.2 (SS models), 6.3 (TLA), and 6.4 (Skate method).

One notable change in modeling structures during this assessment was transition from a year defined according to calendar year (January-December) to a fishing year from September-August. This change was made to better align the data sets and modeled population dynamics to the red drum life cycle (i.e., fall spawning and an assumed biological birthdate of September 1). One drawback was that data originally provided through the 2022 calendar year were not complete for the 2022 fishing year (i.e., no January-August 2023 data) and, therefore, the 2021 fishing year was used as the terminal year in the assessment. This year definition change will be anticipated in future assessments.

SS models for the northern stock showed concerning results in stability diagnostics and were not recommended for stock status determination. However, trend information across analyses in recent years agreed and the SS models are presented for this trend information. The TLA is the recommended approach for stock status determination of the northern stock. The SS model is recommended for stock status determination for the southern stock. Additional analyses for the southern stock are presented as complementary analyses.

4. Discuss the effects of data strengths and weaknesses (e.g., temporal and spatial scale, gear selectivities, aging accuracy, sample size) on model inputs and outputs.

Red drum stock assessments have demonstrated a history of challenges due to the unique combination of life history and regulations that have contributed to notable data limitations (Section 1.3). Key among these are limitations of data on adult fish protected by existing slot limit regulations and high proportions of fishery removals from dead discards caused by slot and bag limit regulations with little data to describe the size compositions of these removals. Limitations of data on adult fish have historically led to “cryptic” adult biomass that is difficult or not possible to estimate. Contemporary adult longline surveys provided six years of data to the last benchmark assessment, but have continued to grow and mature now providing more than double the time series length of the last assessment. There were challenges with modeling these surveys in the current assessment due to some apparent data conflicts, but these surveys are becoming data strengths that provide validation of adult biomass. There are no robust mechanisms to directly sample discard size compositions in recreational fisheries. Various proxy data sources were explored to address this limitation, particularly volunteer angler-based tagging programs (Section 4.2.1.2.2). Proxy data sources provide some limited information, but these data remain a primary limitation for assessments. This limitation leads to uncertainty in partitioning fishing mortality across the population size structure in the assessment models and had to be addressed by fixing some selectivity parameters.

A new development in this current assessment was contrast in fishery-independent indices of abundance for the southern stock, a data strength that provides information on abundance scale and productivity of the stock. Unfortunately, this contrast manifests as declines in recent years. There is still limited contrast in index data for the northern stock. Additionally, there is lack of abundance information north of North Carolina which contributes to a growing uncertainty in the assessment as fishery removals in these areas continue to increase.

Red drum fisheries are primarily recreational and, therefore, assessments are highly dependent on the recreational catch estimates provided by the Marine Recreational Information Program (MRIP). Sensitivity analysis of the assessment models showed that, although scale of estimates is sensitive to multiple uncertainties explored in these catch estimates, trend and stock status estimates are not.

A final notable highlight on data inputs is the time series used in assessments. Data are limited in the 1980s (and before) when red drum fisheries grew and led to implementation of restrictive regulations to curb expected high fishing mortality. There are no fishery-independent indices of abundance in the early and mid-1980s and very few in the late 1980s. Composition

data are sparse and do not start for commercial fisheries until the late 1980s. Catch data also show higher uncertainty (higher proportional standard errors, PSEs) in the 1980s than in later years. However, catch data do show contrast in the early 1980s that matches the perception of higher fishing mortality during these years. One advantage of the SS modeling framework used in the assessment is its ability to handle varying data quantities throughout the modeled time series. In this assessment, the start year was extended back to 1981 from 1989 used in the past benchmark assessment to take advantage of the contrast in early catch data. Sensitivity analysis showed impact from these early data indicative of information the model would miss with a later start year (e.g., 1989).

These data effects on the various assessment approaches are discussed throughout Section 6.

5. State assumptions made for all models and explain the likely effects of assumption violations on synthesis of input data and model outputs. Examples of assumptions may include (but are not limited to):
  - a. Choice of stock-recruitment function.
  - b. Calculation of M. Choice to use (or estimate) constant or time-varying M and catchability.
  - c. Choice of reference points.
  - d. Choice of a plus group.
  - e. Constant ecosystem (abiotic and trophic) conditions.

Parameterizations and assumptions for each assessment approach are described in Section 6. There were a number of fixed inputs to the assessment models that were evaluated with sensitivity analysis to determine their impact on model estimates and stock status. Assessment approaches recommended for stock status determination for each stock (TLA for the northern stock and SS for the southern stock) were generally insensitive to the changes explored in sensitivity analysis.

6. Characterize uncertainty of model estimates and reference points.

Uncertainty was characterized with a combination of techniques including the delta method to generate asymptotic standard errors for model estimates and reference points (CJS model and SS models), retrospective analysis (see below; SS models), and sensitivity analyses (SS models, TLA, and Skate method). These characterizations are covered in Sections 6.1 (CJS model), 6.2 (SS models), 6.3 (TLA), and 6.4 (Skate method).

7. Perform retrospective analyses, assess magnitude and direction of retrospective patterns detected, and discuss implications of any observed retrospective pattern for uncertainty in population parameters (e.g., F, abundance), reference points, and/or management measures.

Retrospective analysis was applied to the southern stock SS model. Instability of the northern stock SS model precluded utility of a traditional retrospective analysis.

The southern stock SS model had a tendency to underestimate SSB and overestimate fishing mortality, indicating the less concerning retrospective bias directionality from a precautionary perspective. Magnitude of the retrospective bias was driven by the three-year peel (terminal year of 2019). The application of adjustments to estimates to account for the retrospective bias did not change the stock status point estimates in the assessment terminal year. For these reasons, the SAS decided not to apply adjustment to final estimates. Details of the analysis are provided in Section 6.2.2.

8. Recommend stock status as related to reference points (if available). For example:
  - a. Is the stock below the biomass threshold?
  - b. Is F above the threshold?

The northern red drum stock was not overfished and was not experiencing overfishing. The TLA fishery performance metric was not red in any of the three terminal years (2019-2021), indicating overfishing was not occurring. The Adult Abundance metric was not red in any of the three terminal years, indicating the stock was not overfished.

The southern red drum stock was overfished and experiencing overfishing in the terminal year of the assessment. The three-year average spawning potential ratio (SPR) in 2021 was 0.207 which is below the threshold (0.30), indicating overfishing. The three-year average relative SSB in 2021 was 0.881 which is below the threshold (1.0), indicating an overfished stock.

Stock status determinations are discussed in Section 7.

9. Other potential scientific issues:
  - a. Compare trends in population parameters and reference points with current and proposed modeling approaches. If outcomes differ, discuss potential causes of observed discrepancies.
  - b. Compare reference points derived in this assessment with what is known about the general life history of the exploited stock. Explain any inconsistencies.

SPR reference points recommended include a target (SPR = 0.30 or 30%) and a threshold (SPR = 0.40 or 40%). These reference points are consistent with reference points recommended in past assessments and were reviewed and deemed appropriate by the Red Drum Technical Committee for red drum life history following the previous benchmark stock assessment (ASMFC 2017b). SSB reference points are new reference points in this assessment, as previous assessment models were believed to be too coarse (age-7 plus group) and data too sparse (short adult longline survey time series) to provide accurate estimates of SSB. The SS models used in this assessment expanded the modeled age structure out to maximum observed age and the adult longline survey time series have grown. The assessment approaches used in this assessment were also shown to perform well estimating SSB status during the simulation assessment preceding this benchmark stock assessment (ASMFC 2022).

A historical retrospective analysis compared estimates from the previous benchmark stock assessment and this current assessment (Section 6.2.2). The analysis for the northern stock

showed divergent SPRs between the previous statistical catch-at-age model and the new SS model in the beginning of the time series with the scale of the SPR estimates from the two models converging around 2010. This early divergence highlights uncertainty with scale and initial condition estimates for the northern stock, contributing to the decision not to use the northern SS model for stock status determination in this assessment. While the scales are different early in the time series, both models show a generally increasing SPR in the early 1990s which begins to decrease in the mid- to late-2000s. These trends are corroborated by increasing trends in fishing mortality estimated with the other assessment approaches applied to the northern stock in this assessment.

The historical retrospective analysis for the southern stock shows very similar SPR estimates in the first four years that overlap between assessments (1989-1992). The SS model in the current assessment then estimates more of a decline for the remainder of the overlapping time series than the statistical catch-at-age model used in the previous assessment. Both assessments estimated a decline in the terminal year of the previous assessment (2013), but the SS model estimates a greater magnitude in this decline. The wide confidence intervals from the last assessment generally include the point estimates and their confidence intervals from the current assessment and demonstrate one of the primary deficiencies of the previous assessment. The decreasing trend in SPR estimated with the SS model is corroborated by increasing trends in fishing mortality estimated with the other assessment approaches applied to the southern stock in this assessment.

10. If a minority report has been filed, explain majority reasoning against adopting approach suggested in that report. The minority report should explain reasoning against adopting approach suggested by the majority.

No minority report was filed.

11. Develop detailed short and long-term prioritized lists of recommendations for future research, data collection, and assessment methodology.

The SAS prioritized eleven short-term and seven long-term research recommendations (Section 8). Short-term recommendations are those that would take less time (1-5 years) to produce results to support future assessments. Long-term recommendations are those that will take a longer period of time (5-10+ years) to produce results to support future assessments. Work on all high priority recommendations should commence immediately.

12. Recommend timing of next benchmark assessment and intermediate updates, if necessary, relative to biology and current management of red drum.

The SAS recommends conducting the next benchmark assessment in five years to allow for six additional fishing years (through 2027) of data past the terminal year in this assessment. The SAS does not recommend allowing a greater period between assessments due to the condition of the stocks in this assessment.

Before the next benchmark assessment, the SAS recommends updating the TLAs every two years, with the first update using the 2023 fishing year as the terminal year and the second update using the 2025 fishing year as the terminal year.



## **1 INTRODUCTION**

### **1.1 Management Unit Definition**

The ASMFC manages red drum under the authority of the Atlantic Coastal Fisheries Cooperative Management Act (ACFCMA), with the management unit defined as the red drum resource throughout the range of the species within U.S. Atlantic coast waters of the estuaries eastward to the offshore boundaries of the Exclusive Economic Zone (EEZ) from Florida through New Jersey. The selection of this management unit is based on the biological distribution of the species along the Atlantic coast and historical harvest patterns, which have identified fisheries for red drum. The management unit is divided into a southern stock and a northern stock. The southern stock includes the waters of the Atlantic coast of Florida north to the North Carolina/South Carolina border. The northern stock extends from the North Carolina/South Carolina border north through New Jersey.

### **1.2 Regulatory and Management History**

The ASMFC adopted a Fishery Management Plan (FMP) for red drum in October 1984 (ASMFC 1984) with an original management unit of the states from Florida to Maryland. The plan was designed to address recreational-commercial conflicts and lack of data needed to define optimum yield (OY). At this time, the ASMFC managed red drum in tandem with the South Atlantic Fishery Management Council (Council). The Council managed red drum in federal waters whereas the ASMFC managed state waters. The plan adopted the following objectives:

- 1) Attain, over time, optimum yield.
- 2) Maintain a spawning stock sufficient to minimize the possibility of recruitment failure.
- 3) Promote the cooperative interstate collection of economic, social, and biological data required to effectively monitor and assess management efforts relative to the overall goal.
- 4) Promote cooperative interstate research that improves understanding of the biology and fisheries of red drum.
- 5) Promote harmonious use of the resource among various components of the fishery through the coordination of management efforts among the various political entities having jurisdiction over the red drum resource.
- 6) Promote determination and adoption of the highest possible standards of environmental quality and habitat protection necessary for the natural production of red drum.

To move towards optimum yield, the original FMP recommended states institute a 14 inch total length (TL) minimum length limit with comparable mesh size regulations instituted to minimize harvest of small fish in directed fisheries. Further, it recommended states bar possession of

greater than 2 fish 32-inch TL and greater per day and a prohibition of purse seining for red drum.

In November 1990, the Council adopted a similar FMP for red drum that defined overfishing and OY consistent with the Magnuson-Stevens Fishery Conservation and Management Act of 1976. Adoption of this plan prohibited harvest of red drum in the EEZ, a moratorium which remains in effect today. Recognizing all harvest would take place in state waters, the Council FMP recommended states implement measures to constrain harvest. Further, it defined OY as the harvest amount that could be taken while maintaining spawning stock biomass per recruit (SSBR) at or above 30% of the level which would result if fishing mortality was zero (i.e., spawning potential ratio, or SPR, of 30%) and recommended states implement measures to achieve at least 30% escapement of sub-adult red drum to the offshore adult spawning stock.

Following this request, ASMFC initiated Amendment 1 to the ASMFC red drum FMP, which went into effect in October 1991. This Amendment adopted the SAFMC FMP for red drum and recommended complimentary measures for states (New Jersey through Florida) to achieve OY.

Substantial reductions in fishing mortality were necessary to achieve the escapement rate; however, the lack of data on the status of adult red drum along the Atlantic coast led to the adoption of a phase-in approach with an initial 10% SPR goal. In 1991, states implemented or maintained harvest controls necessary to attain the goal. Per ASMFC Amendment 1, ASMFC recommended states adopt either an 18–27-inch TL slot limit and 5 fish person<sup>-1</sup> bag limit (1 fish >27 inches TL) or a 14–27-inch TL slot limit and 5 fish person<sup>-1</sup> bag limit.

Amendment 1 and Amendment 2 to the Council's FMP both went into effect in October 1998. Amendment 1 updated MSY to 30% SPR, OY to 40% SPR, an overfishing status at less than 30% SPR, and an interim overfishing threshold as 10% SPR (ASMFC 2002). Amendment 2 identified, described and recommended measures to protect Essential Fish Habitat (EFH) and EFH Habitat Areas of Particular Concern for red drum as part of the Council's comprehensive habitat amendment (SAFMC 1998b).

In 1999, the Council recommended management authority for red drum be transferred to the states under the ACFCMA. This was recommended, in part, due to the inability to accurately determine an overfished status, and therefore stock rebuilding targets and schedules, as required under the revised Sustainable Fisheries Act of 1996. The transfer necessitated the development of an amendment to the ASMFC FMP to include the provisions of the ACFCMA.

The subsequent amendment, Amendment 2 to the ASMFC FMP, moved management authority of red drum from the Council to the states in June 2002 (ASMFC 2002) and serves as the current management plan. The final rule that repealed the Council's FMP and transferred management authority of Atlantic red drum in the EEZ from the Council to the ASMFC became effective November 5, 2008. The Amendment required states to implement recreational creel and size limits to achieve the fishing mortality target, including a maximum size limit of 27 TL, and maintain existing or more conservative commercial regulations. A harvest moratorium and Presidential Executive Order, enacted in 2007, prevents any harvest or sale of red drum from

federal waters. The goal of Amendment 2 is to achieve and maintain the OY for the Atlantic coast red drum fishery as the amount of harvest that can be taken by U.S. fishermen while maintaining the SPR at or above 40%. There are four plan objectives:

- 1) Achieve and maintain an escapement rate sufficient to prevent recruitment failure and achieve an SPR at or above 40%.
- 2) Provide a flexible management system to address incompatibility and inconsistency among state and federal regulations which minimizes regulatory delay while retaining substantial ASMFC, Council, and public input into management decisions; and which can adapt to changes in resource abundance, new scientific information, and changes in fishing patterns among user groups or by area.
- 3) Promote cooperative collection of biological, economic, and sociological data required to effectively monitor and assess the status of the red drum resource and evaluate management efforts.
- 4) Restore the age and size structure of the Atlantic coast red drum population.

The SPR of 40% is considered a target; an SPR below 30% (threshold level) results in an overfishing determination for red drum. All states were in compliance by January 1, 2003.

The Board approved Addendum I to Amendment 2 in August 2013. The Addendum sought to increase the knowledge base and aid in the protection of important red drum habitat by updating Amendment 2's habitat section to include more up to date information on red drum spawning habitat and habitat by life stage (egg, larval, juvenile, sub-adult, and adult). The addendum also identified and described the distribution of key habitats of concern, including threats, habitat bottlenecks, and ecosystem considerations.

Red drum state-specific regulations through time are provided in Table 1 (northern stock) and Table 2 (southern stock).

### **1.3 Assessment History**

There have been eight previous regional benchmark assessments for red drum inhabiting Atlantic coast waters of the U.S. (Vaughan and Helser 1990; Vaughan 1992; Vaughan 1993; Vaughan 1996; Vaughan and Carmichael 2000; SEDAR 2009a; SEDAR 2015a; ASMFC 2017b). The most recent regional assessment project for red drum was an assessment of simulated red drum stocks to support model selection for this current benchmark assessment (ASMFC 2022). There have also been state-specific assessments conducted in Florida, South Carolina, and North Carolina.

#### **1.3.1 Regional Stock Assessments**

Early regional assessments (through Vaughan 1993) analyzed red drum as one coastwide stock and used catch curves and virtual population analyses (VPAs) to analyze the catch age

composition data of only young red drum (ages 0-5 – see note on age convention in next paragraph). These early assessments were designed to remove the effect of emigration on the apparent decline (mortality) in catches of red drum as they moved from heavily fished inshore sub-adult habitats to more lightly fished offshore adult habitats. For the most part, the condition of the stock was inferred from the calculated level of escapement through age-5, though they also calculated SPR (reported in these assessments as maximum spawning potential or MSP) as a management benchmark despite little information on adult catches. These assessments estimated high mortality and low escapement and SPR throughout the 1980s and into the early 1990s.

Beginning with Vaughan (1996), the assessment separated the coastwide population into the two stock definitions currently used in assessments, a northern stock from the SC/NC border north and a southern stock from the SC/NC boarder through SE FL along the Atlantic coast. Major concerns beginning in this assessment were increasing numbers of live releases (and resultant dead discards) in the highly regulated recreational fisheries and the effects of minimum/maximum size restrictions complicating estimation of selectivity. The assessment introduced the use of VPA with indices of abundance included as inputs (tuned VPA). Given the difficulties estimating the decline in vulnerability associated with the sub-adult transition to offshore waters, the assessment used a series of predefined linkages between age-specific selectivities to constrain the analyses. This assessment estimated high mortality and low SPR (<15%) continuing into the mid-1990s.

The next assessment by Vaughan and Carmichael (2000) used two VPAs (SVPA and FADAPT) and a spreadsheet-implemented, forward projecting statistical catch-at-age analysis. It should be noted there was a change in the definition of the age designation during this assessment that was maintained in all subsequent assessments until the current assessment (see Section 1.3.4). The first calendar-year age in early assessments was designated age-0 (January-December for biologically 4-16 month old fish). This was redefined as age-1 (given the convention of incrementing age on January 1) in the 2000 assessment. The assessment investigated uncertainty in the age structure of live-released mortalities was investigated by manipulating the lengths of red drum measured from angler creels. A range of release mortalities and selectivity linkage constraints were utilized in all analyses. The FADAPT VPA was selected as the preferred analysis for estimates of fishing mortality and SPR. In the northern stock, estimates of SPR increased from 1.3% for the period 1987-1991 to approximately 18% for the period 1992-1998. For the southern stock, estimates of SPR increased from 0.5% for the period 1988-1991 to approximately 15% for the period 1992-1998. These estimates indicated overfishing was occurring in both stocks.

The first SouthEast Data, Assessment, and Review (SEDAR) process for red drum, SEDAR 18, concluded in 2009 with data through 2007 (SEDAR 2009a). This assessment transitioned to new forward projecting statistical catch-at-age (SCA) models developed in AD Model Builder (ADMB). These SCA models relax assumptions required by the precursor VPA analyses that assume catch age composition data are observed without error and were seen as advancements in models due to some data limitations in constructing the age composition

data. The models included several unique aspects due to data availability and red drum life history, including the constraint of estimating selectivity of ages-4 and 5+ as proportions of age-3 selectivity, grouping all ages older than age-6 into a plus group, and using fishing mortality and selectivity information from an external tagging analysis in the modeling procedures (northern stock only). The models used fishery catch and age compositions, indices of abundance, and life history information (growth, maturity, and natural mortality). Like the VPAs, these models produced fishing mortality estimates that could be used to calculate SPR for comparison to reference points and status determination.

In the northern stock, SPR estimates increased from lows less than 10% in the beginning of the time series to values above the target (40%) by the mid-1990s. SPR was estimated to have varied at these higher levels above the threshold and often above the target for the remainder of the time series. In the southern stock, SPR was estimated to have been at the highest levels in the early 1990s then declined slowly but remained above the threshold and target throughout the rest of the time series. The assessment provided a three-year average SPR over the last three years of the assessment time period (2005-2007) for stock status determinations to address uncertainty with annual estimates. Both stocks were determined not to be experiencing overfishing. Due to data limitations and poor estimates of the adult components of the stocks, the assessment could not make a determination of spawning population status (i.e., overfished vs. not overfished).

This assessment was accepted by a peer review panel (RP), but peer reviewers noted limitations and concerns with the SCA models that should be addressed in future assessments. The northern model was sensitive to inclusion of the external tagging analysis estimates used as inputs in the base model configuration and results were conditional on these inputs. Without these inputs, results were different and indicated conflict between these inputs and the other more traditional data inputs (catch age composition, indices of abundance). Further, the reviewers noted unusually high fishing mortality estimates from the external tagging analysis early in the time series. The RP recommended direct inclusion of the tag-recapture data as model inputs in future assessments as opposed to externally-derived population parameter estimates.

Peer reviewers also expressed concern with uncertainty of model estimates, particularly for the southern stock. Confidence intervals were large and results were sensitive to selectivity estimates, allowing for only general, qualitative statements about stock conditions. Reviewers noted highly uncertain and unrealistically large initial abundance estimate for older fish in the southern and northern models, respectively. These issues were explored during the workshop but remained after not arriving at solutions. Poor fits to catch age composition data resulted in age-specific patterning in residuals and the model time series was shortened during the review to exclude sparse composition data prior to 1989. The assessment team and RP agreed that model structure was a major source of uncertainty in the assessment.

During a second SEDAR process in 2015 (SEDAR 44; SEDAR 2015a), an attempt was made to transition to integrated assessment models developed with the Stock Synthesis (SS) integrated

analysis framework (Methot and Wetzel 2013). This transition was in response to limitations of the SCA models and recommendations by the SEDAR 18 peer RP. SS is an age- and size-structured assessment model in the integrated analysis class of models. It has 1) a population sub-model that simulates growth, maturity, fecundity, recruitment, movement, and mortality processes, 2) an observation sub-model which predicts values for the input data, 3) a statistical sub-model which characterizes goodness of fit and obtains best-fitting parameters and their associated variance, and 4) a forecast sub-model which projects various user-determined management quantities (Methot et al. 2023). SS allows for observed tag-recapture data and both length and age length key data as inputs, reducing data processing external to the model and better propagating uncertainty in model results. SS is also more flexible for modeling time series with varying data availability and the framework was anticipated to better utilize sparse data during the period of high exploitation prior to the 1989 start year in SEDAR 18.

Several challenges were experienced during model development resulting in poor model stability and no preferred model in time for the peer review workshop, so the objective of the workshop changed from evaluating final model results for management advice to evaluating current model configurations and making recommendations to improve these configurations. The assessment team addressed recommendations following the workshop and final model results were reviewed during a subsequent peer review. The SPR estimates were quite different from SEDAR 18, indicating the stocks had been experiencing overfishing throughout the time series. The 2011-2013 three-year average SPR was estimated to be 9.2% in the northern stock and 17% in the southern stock, both below the SPR threshold.

Peer reviewers accepted the assessment but they identified notable concerns, including sensitivity of the northern model stock status determination to treatment of the tag-recapture data. The models were not accepted by the South Atlantic State/Federal Fisheries Management Board (Board; predecessor of the Sciaenids Management Board) due to concerns with the reliability of population parameter estimates. Instead, the Board tasked the Technical Committee (TC) and Stock Assessment Subcommittee (SAS) with several tasks including to evaluate the utility of the SCA models used in SEDAR 18 for updated management advice.

The SAS updated the SCA models in an additional assessment (ASMFC 2017b) with recent data and explored several potential changes to these models, including data changes, but recommended models with minimal structural changes for management advice. The 2011-2013 three-year average SPR was estimated to be 43.8% in the northern stock and 53.5% in the southern stock, both above the SPR threshold and target, indicating that overfishing is not occurring. However, the issues that arose with the models during SEDAR 18 remained and were noted by the peer reviewers of this assessment.

Peer reviewers noted that examination of the assessment results, as well as corroborating information from the fishery-independent (FI) indices, suggested both the northern and southern stocks appeared to be above their management thresholds. However, reviewers concluded there was a high degree of uncertainty associated with these assessments due to the lack of good fishery-dependent and -independent data on the oldest and most fecund age

classes, coupled with sensitivity to data weightings and initial conditions suggesting an overall scaling problem with both regions' assessments. The wide confidence intervals in the south and the unrealistic decline in abundance over the time series in the north suggest fundamental assessment and data issues. Given the life-history and pattern of exploitation, they stated it was unclear how these issues could be easily resolved. They noted further work was needed given the critical dependency of overfishing status determination on the fishing mortality estimates for older fish and the difficulties of estimating fishing mortality when population size is indeterminate; therefore, the assessment gave only a rough measure of stock status.

### **1.3.2 Simulation Assessment**

The uncertainties and modeling challenges for assessing red drum described above led to the Board tasking the ASMFC's Assessment Science Committee (ASC) with providing a road map for future red drum stock assessments following the most recently completed stock assessment (ASMFC 2017b).

In collaboration with the Red Drum SAS, the road map produced by the ASC recommended evaluating three potential frameworks to develop management advice from the next benchmark stock assessment (in no particular order):

1. model-free stock indicators, similar to traffic light analyses used for Atlantic croaker and spot,
2. a population dynamics model tracking the juvenile components of the stocks, and
3. a population dynamics model tracking all life stages of the stocks.

The anticipated advantage of the first framework was being able to provide advice on all life stages with data currently available, with the most notable disadvantage being no quantitative stock status estimates. Rather, this framework would provide stock status as changes in individual data sets or indicators relative to a predefined period in the available data. The anticipated advantage of the second framework was being able to provide estimates of stock status relative to potential productivity from integrated juvenile data (currently available), with the most notable disadvantage being stock status estimates that are not directly influenced by changes in the mature, adult components of the stocks (data currently limited or not available). The anticipated advantage of the third framework was being able to provide estimates of stock status relative to potential productivity from integrated data across life stages, but estimates from this framework were likely to have relatively high levels of uncertainty given data limitations on adult components of the stocks (i.e., lack of age composition data characterizing dead discards). Further, the Board had expressed interest in being able to determine whether or not the stocks can be declared rebuilt or not, necessitating the estimation of the adult component of the stocks and encouraging the exploration of this third framework.

The road map recommended the use of simulation analyses as the basis for evaluating these potential frameworks. Simulation models would be used to simulate red drum stocks, with

known population dynamics, subjected to various fishing mortality scenarios, with the simulated stocks subsequently being sampled for data mimicking available data streams for stock assessment of *in situ* stocks. Data streams would then be applied to the three potential frameworks to evaluate their reliability in characterizing the known stock status of the simulated stocks. The results would be used to infer reliability of the candidate frameworks when applied to the *in situ* red drum stocks and to recommend the preferred framework(s) for providing management advice during subsequent stock assessments of the *in situ* stocks. Simulation testing was also recommended to identify the data deficiencies causing uncertainty in assessment advice to focus improvements in data collection efforts.

The recommended timeline was for a two-stage assessment process over a four-year period, with a first stage devoted to a simulation analysis and a second stage devoted to a traditional benchmark stock assessment of *in situ* stocks (which this report covers). The Board agreed with the recommendations in the roadmap at the ASMFC 2020 Winter Meeting and initiated the development of the simulation assessment. The simulation assessment was completed and peer reviewed in Spring 2022 (ASMFC 2022).

The simulation process used consisted of several steps. The first step was the data simulation process, where observed data from *in situ* monitoring programs were used to construct simulated populations of the northern and southern red drum stocks. The operating models (OMs) were developed with the *ss3sim* R package (Anderson et al. 2014; Johnson et al. 2021), a simulation platform to complement the SS modeling framework. Simulated sampling datasets were then sampled from simulated stocks with the OM and passed to each of the estimation models (EMs) being considered as candidates for future red drum stock assessment models.

The simulation assessment evaluated the performance of three candidate assessment models: a traffic light analysis (TLA) of model-free stock indicators, used previously for Atlantic croaker and spot management advice; the SCA models used for the most recent red drum benchmark stock assessment in 2017; and an SS model using the platform attempted in SEDAR 44 and widely used in stock assessments.

The assessment approaches were evaluated based on their performance estimating population parameters important to management through multiple iterations of each simulation scenario. Assessment model estimates were compared to the known population parameters of the OM to calculate performance metrics, and these performance metrics were compared to those of the other assessment models to evaluate relative performance across assessment models. Evaluation of performance was both qualitative and quantitative.

The first evaluation criterion was the ability of a given model to successfully run an iteration of a scenario and converge on a solution (only applies to SCA and SS EMs). Models may have varying amounts of difficulty running scenarios depending on specification and convergence rates provides information on the stability of the estimation model.

If a model successfully ran an iteration, performance was then evaluated on how each approach estimated stock status/condition and the precision and accuracy of parameters. For



stock status/condition, Type I and Type II error rates were the metrics of interest. Type I error (false positive) was defined as incorrect rejection of a null hypothesis of favorable condition/status (e.g., stock was estimated to be in poor condition when it was really in good condition), while Type II error (false negative) was the incorrect rejection of a null hypothesis of unfavorable condition/status (e.g., stock was estimated to be in good condition when it was really in poor condition). Error rates were quantified by their frequency of occurrence across iterations for a given model and scenario. Relative error was used to assess precision and bias of quantitative population parameter estimates for each model. Relative error was used quantitatively to examine the magnitude and direction of error for individual parameter estimates.

Simulation scenarios to be addressed in the assessment were identified at the beginning of the assessment and grouped into two types: core population dynamics scenarios and data prioritization scenarios. Core population dynamics scenarios were to evaluate candidate assessment approaches for assessing red drum stocks with status quo monitoring under various scenarios that may play out in future red drum stock assessments. The data prioritization scenarios were designed to evaluate improvements in modeling performance with changes to status quo monitoring with a goal of informing research recommendations for future monitoring of red drum stocks.

The simulation results led to a recommendation from the SAS to pursue both the SS and TLA assessment approaches in the upcoming assessment for the northern stock of red drum; further pursuit of the SCA model for the northern stock was not recommended. The SCA had two identified and concerning deficiencies detracting from its use as an assessment model for the northern stock, namely its sensitivity to weighting scheme and reliance on Bachelier et al. (2008) tag-based data inputs.

The SS model performed as well or better than the other northern EMs in terms of accuracy. Additionally, the SS model performed well under the *2023 Term Yr* scenario, which included shortened time series to mimic that anticipated in the upcoming benchmark assessment. This was indicated by a general lack of a decrease in precision of the SS model under the *2023 Term Yr* scenario relative to the *Base* scenario, which included longer time series simulated well beyond the terminal year anticipated in the upcoming benchmark assessment.

Investigation of the TLA suggested there is utility in continuing to develop it as a potential assessment methodology for red drum. For the northern stock, it is comparable to the SS EM in making spawning stock biomass status determinations, and outperforms SS when characterizing recruitment condition. Hence the TLA showed utility as a supplementary, alternative assessment approach for development of SSB status and recruitment condition determinations. Such development was recommended to occur simultaneously with the SS model in the upcoming benchmark assessment. An additional benefit of further TLA model development was its relative ease to update; this suggests a TLA approach could be used during interim periods between formal assessments to update stock status for management advice.

However, use of the TLA for fishing mortality status determinations in the northern stock was cautioned due to its poor performance in terms of error rates.

The simulation results also led to a recommendation from the SAS to pursue all three assessment approaches in the upcoming assessment for the southern stock of red drum given more consistency in performance across approaches. Relative to the southern SCA EM, the southern SS EM estimated with slightly greater precision during the projected period in the immediate future, though the SCA EM estimated with greater accuracy. However, the SS model remains a more flexible assessment platform, which should be a benefit to the assessment of the southern stock of red drum with its unique fishery and life history characteristics that pose challenges to traditional statistical catch-at-age models. The southern stock results indicated the TLA was useful for all metrics, including fishing mortality status, which was deemed an unreliable TLA metric for the northern stock. Further, error rates in stock status, in terms of fishing mortality status and SSB status, were comparable to both the SCA and SS EMs for the southern stock and the TLA continued to outperform the age-structured models in characterizing recruitment condition. Hence the TLA showed utility as a supplementary, alternative assessment approach for development of fishing mortality status, SSB status and recruitment condition determinations in the southern stock. The SCA continued to show sensitivity to changes in weighting schemes, with weighting affecting mostly convergence rates. However, compared to the effect changing weight had on the SCA for the northern stock, the change in weighting had less of an effect on scale estimation and did not affect the trend of estimates for either stock. One caution was indicated by the results for the SCA model that should be considered in the upcoming benchmark assessment. Though precision of the SCA estimates was reasonable and comparable to the other considered EM approaches when evaluated for the full simulated time series, precision drastically decreased under the *2023 Term Yr* scenario. This is similar to the situation noted during the ASMFC 2017 benchmark stock assessment.

Finally, it became apparent during the review of the results that models, specifically for the southern stock, provided accurate trends in  $F$ , SSB, and recruitment. As such, this suggested a potential alternative management approach for red drum could be developed based on trends and levels relative to a reference time period. This is similar to the approach used for the development of stock status recommendations for the ASMFC-managed Atlantic menhaden (ASMFC 2017a). Work would be needed to define an appropriate time period to develop such a set of reference points, including input from the Board.

A final objective of the simulation assessment was to develop scenarios useful for identifying data prioritizations necessary to improve the accuracy and precision of stock status estimates. These scenarios included evaluating the length of the adult longline survey time series, changes in recreational discard composition data availability and quality, and impacts of growth misspecification. Although the results provided some intuitive results to help prioritize future data collections (e.g., improved selectivity estimates with improved discard size composition data), the scenarios produced a number of unintuitive results (e.g., little to no impact to model

results when longline survey data are excluded from the model) that needed further work to fully understand and support future data collection/modeling recommendations.

During the peer review, the RP recommended not pursuing the SCA model for either stock and instead devoting efforts to development of the other two approaches (TLA analysis and SS models). The SAS ultimately agreed with this change as a reasonable path forward in the upcoming benchmark assessment. The RP agreed with the SAS that continued development of the SS models should be prioritized given the SS framework is essentially an SCA approach with more flexibility than the red drum SCA model and the TLA showed utility as a complementary assessment approach that should also be prioritized for application in the upcoming benchmark.

The RP did make a number of recommendations during their review, with two being considered by the SAS as the highest priority for addressing following the simulation assessment. The RP expressed concern over the method for determining the reference points used in the evaluation of TLA performance. The grid search method used information from the entire time series of the simulation, including the projection years. Therefore, the TLA leverages information not available to the other models and would not be available to a TLA based on *in situ* data. The RP recommended repeating the grid search using only the ‘burn in’ and pre-2023 periods to see if the reference points identified were similar to the ones identified in the presented assessment. The reduced time series grid search would be more directly comparable to the other assessment models and would be representative of options available in an *in situ* application of the TLA. Second, during the peer review, the RP requested EMs be fit to data from the OM generated without observation error. While the northern SS EM was able to produce unbiased parameter estimates from these data, the SS EM for the southern stock could not produce unbiased parameter estimates during the review workshop. The RP noted the southern SS EM needed additional work to determine if the model could produce unbiased estimates while using data without observation error from the OM.

Finally, it was noted during the simulation assessment that recommendations should guide workloads and preparation for the upcoming benchmark, though, ultimately, the preferred approach would depend upon fits to the observed data from *in situ* stocks available in the benchmark.

### **1.3.3 State Stock Assessments**

#### **Florida**

The Florida Fish and Wildlife Conservation Commission (FL FWC) has conducted several assessments of red drum, with the most recent assessment utilizing data through 2019 (Addis 2020). This assessment was conducted to assess the status of red drum populations found in four different regions along the Atlantic and Gulf Coast of Florida. The two regions of the Atlantic coast were defined as the southeast region (SE), from Miami-Dade through Volusia counties, and the northeast region (NE), from Flagler through Nassau counties.

SS models were developed, run from 1989 to 2019, accounted for 41 ages (0-40+), and were fit to catch, CPUE indices, length composition, and size-at-age data. Fits to the datasets from a parametric bootstrap analysis were adequate for all regions as most base run estimated parameters and derived quantities were inside the central range of the estimates produced by the bootstrap analysis.

Overall fishing mortality rate estimates for red drum ages 1- remained at low levels since the late 1980s in all four regions, though, recent increases in fishing mortality rates were apparent in the NE from 2010-2019 and the SE from 2015- 2018. Terminal year spawning stock biomass (SSB) was estimated to be 17,163 and 27,940 mt in the NE and SE regions, respectively.

Ratios of  $SSB_{current}/SSB_{SPR35\%}$  and  $F_{current}/F_{SPR35\%}$  from the two assessment regions indicated red drum were neither overfished nor undergoing overfishing in Florida.

Estimates of current escapement rates in the NE region exceeded 40%. Finally, although the SE region of Florida exceeded the escapement rate management target in the terminal year (2019) of the assessment (55%), it did not meet the current escapement rate management target. Escapement rates for 2017-2019 were 61% and 35% in the NE and SE regions, respectively.

### South Carolina

Using data from September 1982 thru August 2016, the South Carolina Department of Natural Resources (SC DNR) conducted a stock assessment to assess the status of the red drum population found along coastal South Carolina (Murphy 2017). Data used included catch, effort, relative abundance, size/age composition, and tag-recapture data sets. The assessment investigated three different assessment frameworks, a SS model excluding tag-recapture data, a SS model including tag-recapture data, and a SCA model as employed during ASMFC 2017b, with each giving broadly similar results.

The assessment suggested the abundance of juvenile and sub-adult red drum along coastal South Carolina increased from low levels in the early- to mid-1980s in response to increasing levels of recruitment in the early 1980s despite high levels of fishing. Abundance of adult red drum continued to remain low or decline until the mid-late 1980s when these abundant groups of sub-adults recruited to the adult population and the abundance of adults began to rise. Fishing mortality declined dramatically after hitting peak values during 1985-1988 and continued declining at a slow rate through the late 1990s. During this time, the red drum population responded with variable but slowly declining recruitment, and an increased abundance of sub-adults and adults. Fishing mortality began to increase steadily after 2000 as the number of discarded red drum (and inevitable discard deaths) increased dramatically. Finally, recruitment declined rapidly after 2008 and abundance of sub-adults and adults followed suit after 2010. SPR increased from low levels in the 1980s to levels exceeding typical biological target levels during the 1990s and early to mid-2000s. Since 2008, SPR levels have fluctuated between about 20-40% before declining in the 2014 and 2015 fishing years to likely be below 20%, indicating the population was experiencing overfishing.

### North Carolina (description modified from Vaughan 2009)

An assessment was conducted by the North Carolina Division of Marine Fisheries (NCDMF; Takade and Paramore 2007) and included data provided by the Virginia Marine Resources Commission (VMRC) to update the earlier assessment by Vaughan and Carmichael (2000) for the northern red drum stock.

The northern red drum stock was assessed using commercial, recreational, and fishery-independent data from 1986 to 2005. Results were broken into three regulatory periods with relatively uniform regulations (early: 1986-1991, mid: 1992-1998, and late: 1999-2005). A major assumption in this assessment was assigning an accurate length distribution to released fish from the recreational fishery. While several assumptions on the length distribution of recreational releases were calculated, the preferred matrix used length frequencies estimated from modeling of NCDMF tag returns. Late period age-3 selectivity was estimated to be 0.48 of fully selected fish (age-2), and was estimated from modeling of NCDMF tag returns. Two models from the Vaughan and Carmichael (2000) assessment were updated: the backward calculating FADAPT VPA and the forward calculating spreadsheet catch-at-age model.

Fishing mortality estimated from FADAPT ranged from 0.50 to 0.49, with escapement ranging from 40.6% to 41.0% and SPR ranging from 40.4% to 40.8%. The spreadsheet catch-at-age model fishing mortality estimates ranged from 0.66 to 0.63, with escapement estimated at 32.8% and SPR estimated at 32.3%. All estimated runs using the TAGGING matrix from both models were above the threshold of 30% SPR and the FADAPT estimates were above the target of 40% SPR. All runs showed improvements in escapement and SPR from the previous regulation period (1992-1998).

This assessment indicated that fishing mortality had decreased and escapement and SPR had increased for the red drum northern stock during the latest management period (1999-2005). The updated model estimates in this assessment were all above 30% SPR and, therefore, indicated overfishing was no longer occurring. It appeared the condition of the northern red drum stock had improved and that the more restrictive management measures implemented had aided in that improvement.

#### **1.3.4 Year Definition for Stock Assessment**

All previous red drum stock assessments have been conducted with a calendar year definition from January 1 through December 31. Age data had been adjusted assuming a January 1 birthdate to keep cohorts together and advancing through the age structure of the assessment time series. During the current stock assessment, the SAS decided to change to a fishing year definition from September 1 of calendar year  $y$  through August 31 of calendar year  $y+1$  (i.e., fishing year 2021 covers September 1, 2021 through August 31, 2022). This change was made to better align the data sets and modeled population dynamics to the red drum life cycle (i.e., fall spawning and an assumed biological birthdate of September 1). With this year definition, age data no longer need adjustments for the January 1 birthdate convention used for a calendar year and each age class in this assessment experiences a full 12 months before

advancing to the next age class. This also aligns the assessment year definition with the management year definition for some states that specifically set regulations based on a fishing year definition (e.g., North Carolina).

## **2 LIFE HISTORY**

### **2.1 Stock Definitions**

Red drum inhabit nearshore and estuarine waters of the U.S. Atlantic coast from Massachusetts to Florida and the Gulf of Mexico (GoM) from Florida to northern Mexico (Lux and Mahoney 1969; Mercer 1984). Despite encountering an occasional individual further north, the current distribution of red drum in the Atlantic Ocean, as indicated by commercial and recreational landings, primarily extends from southern Florida to the Chesapeake Bay, with infrequent, low catches in states north of the Chesapeake Bay. Early stock assessments (Section 1.3.1) divided this distribution into a northern stock (North Carolina through New Jersey) and a southern stock (South Carolina, Georgia, and the eastern coast of Florida) based on differences identified in life history characteristics (maximum age, growth, and maturity), as well as movement information from tagging data. Seyoum et al.'s (2000) initial mitochondrial genetic work on red drum indicated a weak subdivision of red drum into GoM and Atlantic components with a genetic transition occurring around the southern Florida peninsula between Sarasota Bay and Mosquito Lagoon, supporting the separate management of these populations. Large-scale genetic analyses have been conducted on red drum in the GoM by Gold et al. (2001) and Gold and Turner (2002).

Based on mitochondrial and microsatellite data, estuaries within the GoM showed temporal, but not spatial stability in allele frequencies. Further analyses of spatial patterns indicated the variability was not able to be partitioned into discrete geographic subpopulations, instead showing a pattern of isolation by distance. The proposed model of population structure fits well with gene flow predicted by life history and due to their estuarine-dependent recruitment; a steppingstone model where gene flow primarily occurred among adjacent estuaries was described with geographic neighborhoods limited to 700-900 km. Additionally, the degree of genetic divergence detected was similar between the two markers, indicating the occurrence of sex-biased gene flow, due to female mediated dispersal and/or male philopatry.

Two early studies have addressed red drum population structure within the Atlantic (mitochondrial sequence data, Seyoum et al. 2000; microsatellite data, Chapman et al. 2002), both indicating little to no level of spatial structuring among estuaries. However, the Atlantic spatial scale of both projects was limited and likely confounded by low sample sizes.

Additionally, an estuarine-collapsed analysis indicated temporal heterogeneity in the SC evaluation and was interpreted as a potential temporal instability of the reproductive pool (Chapman et al. 2002). Chapman et al. (2002) estimated a variance effective population size ( $N_e$ ) of Atlantic red drum using the temporal method of Waples (1989), which was an order of magnitude lower than estimates of female  $N_e$  in the GoM (Turner et al. 1999). However, due to

red drum overlapping generations, an estimate of  $N_e$  requires a modification based on age specific life history information (Jorde and Ryman 1995). At that time, the only correction factor available for red drum was based on GoM fish (Turner et al. 1999); however, the appropriateness of those data for Atlantic red drum is unlikely based on suspected age structure differences resulting from differential commercial fishery impacts during the 1980s. Therefore, determination of age-specific survival and birth rates are needed to determine accurate estimates of  $N_e$  for Atlantic red drum.

More recently, the South Carolina Department of Natural Resources (SCDNR) used genetic samples from adult red drum collected from a multi-state longline surveys and other sampling efforts to evaluate genetic structure from NC to FL (Cushman et al. 2014). Temporal genetic differentiation was tested for within each of six sampling sites from NC to FL and found to be insignificant. Spatial genetic differentiation was then tested between the six sampling sites during the spawning season and non-spawning season. Significant differentiation was detected between NC and all southern sample sites (SC-FL) during the spawning season, but not during the non-spawning season. This work suggests a genetic break does exist between NC and locations south of NC during spawning, but some mixing of adults occurs during the non-spawning season. This mixing is less of a concern based on current management of the defined stocks which protects adult fish from harvest (i.e., no mixed stock harvest). Estimates of  $N_e$  also supported the greater abundance of the southern stock estimated in previous stock assessments.

Previous stock assessments have defined the unit stocks as a southern stock, individuals from South Carolina and south, and as a northern stock, individuals from North Carolina and north. Questions arose within the SAS as to whether the state line was the most appropriate definition between these two stocks, or would another location be a more appropriate boundary between these two stocks. Using visual observations of the North Carolina traditional tag and recapture data since 2014 ( $n=1,680$ ), we examined whether a different geographic boundary between the stocks may exist.

An examination of the North Carolina tagging data revealed most individuals tagged in North Carolina stayed within the state or moved north. There were four individuals that moved south into South Carolina. Waterbodies that correspond with the NC Trip Ticket data (to promote ease of splitting sampled data) were visually inspected with tag and recaptured locations plotted to determine if any area had relatively low occurrence of red drum recaptured on opposite sides of the waterbodies. The waterbody with the lowest number of red drum that crossed the examined boundaries was the White Oak River, where only thirty-seven fish (2.2% of recaptures) were tagged and recaptured on opposite sides of the boundary. Red drum tagged and recaptured in South Carolina were not examined in this analysis. Age frequencies and estimated von Bertalanffy growth rates were then examined for red drum captured south of the White Oak River. The growth rates from red drum captured south of White Oak River were compared to the growth rates of red drum captured from the rest of the North Carolina and growth rates from red drum captured in South Carolina.

Inversely weighted von Bertalanffy growth models were then developed with the northern North Carolina age-length data (n=12,465), the southern North Carolina age-length data (n=1,775), and the South Carolina age-length data (n=94,252). Fractional ages were used in the analysis. The von Bertalanffy growth models were then compared using an Analysis Residuals Sum of Squares (ARSS).

### North NC versus Southern NC

Only 1,775 red drum were captured in or south of the White Oak River compared to the 12,465 captured north of the river. Most individuals captured were age 0, 1, or 2 with only 1.6% of red drum captured in White Oak River or south being age 3 or older compared to 10.4% of red drum north of White Oak being age 3 or older (Figure 1, ages 0-2 were removed from figure to demonstrate the less frequently captured age distributions). The von Bertalanffy growth parameters indicated red drum captured north of the White Oak River grew larger but slower than red drum captured in or south of the White Oak River ( $p < 0.0001$ ,  $F = 389.7$ ,  $df = 14,234$ , Table 3, Figure 2). However, the difference could be due to the lack of older individuals captured from White Oak River south.

### SC versus Southern NC

The 1,775 red drum captured in or south of the White Oak River were compared to the 94,252 red drum captured in South Carolina. Most individuals captured were age 0, 1, or 2, with only 1.6% of red drum captured in White Oak River or south being age 3 or older compared to 19.8% of red drum captured in SC being age 3 or older (Figure 3, ages 0-2 were removed from figure to demonstrate the less frequently captured age distributions). The von Bertalanffy growth parameters indicated red drum captured south of the White Oak River grew larger but slower than red drum captured in SC ( $p < 0.0001$ ,  $F = 235.6$ ,  $df = 96,021$ , Table 4, Figure 4). However, the difference could be due to the lack of older individuals captured from White Oak River south.

In conclusion, there was not sufficient data in the southern part of North Carolina to distinguish if those individuals were part of the southern stock, northern stock, or were located in a transition zone with individuals from both stocks. The SAS decided to stay with the prescribed stock definition outlined in the previous stock assessments and simulation assessment.

## **2.2 Migration Patterns**

Adult red drum make seasonal migrations along at least some parts of the Atlantic coast. In the spring, adults move north and inshore, but offshore and south in the fall. Overall, adults tend to spend more time in coastal waters after reaching sexual maturity. However, they do continue to frequent inshore waters on a seasonal basis. In the Indian River Lagoon (IRL), Florida, limited seasonal migrations, including some movement to coastal inlets in fall during the spawning season, have been detected (Reyier et al. 2011). In Mosquito Lagoon (northern IRL), a portion



of the adult population remain within the estuary where documented spawning occurs (Johnson and Funicelli 1991; Reyier et al. 2011).

Tagging information provided the best insight into the movement and migration of red drum along the Atlantic coast. Each state, from Georgia to Virginia, has participated in some form of tagging program (Section 4.3). Volunteer angler programs are or have been active in each state, in which trained volunteers participate by tagging fish and reporting tagged fish when recaptured. Other programs include agency staff tagging and cooperative projects with local commercial harvesters. Almost every program relies heavily on angler returns for recapture information.

Despite differences in state-to-state programs, there is evidence of adult red drum movement between Virginia and North Carolina. Data suggest red drum movement into Virginia waters from North Carolina in late May. The fish appear to stay in the area from August through September before they ultimately move during fall months to North Carolina waters where the fish appear to overwinter. Movement of red drum tagged in North Carolina over 25 years is summarized in Bacheler et al. (2009). The study, based on 6,173 tag returns for red drum of all sizes, found limited movement of red drum from North Carolina to adjacent states, although some adult red drum migrated seasonally to Virginia in the spring, returning the following fall. The study noted that the current stock split between North Carolina and South Carolina appeared to be an appropriate ecological division for the stock.

An interesting pattern of movement, or lack of movement, was observed from fish overwintering in the area of power plants. The most productive of these areas was the Elizabeth River Hot Ditch area, in Virginia. Rather than migrating out of the Chesapeake Bay during fall to North Carolina waters (considered the usual pattern for sub-adult red drum in the northern stock), fish in this area were observed over-wintering in bay tributaries in the area of power plants. The cycling of river water through the plants resulted in discharges of warmed water sufficient to maintain adjacent areas at temperatures suitable for the fish (as well as forage the fish could use - crabs, finger mullet, mummichogs, etc.). Similar patterns were observed, to a lesser degree, at another nearby power plant (SEDAR 2009b).

Programs in the southern states (Georgia and South Carolina) provided evidence of limited movement as well. For example, of 1,780 fish tagged in Georgia, 85.3% were recaptured within state waters, 11.0% were recaptured in South Carolina, and 3.7% were recaptured in Florida. In South Carolina, fish tagged in the SCDNR sub-adult tagging program were primarily recaptured within 30 miles (96.4%; SEDAR 2009b). An additional working document on movement distances by South Carolina red drum tags that were recaptured by recreational anglers (Arnott 2015b) indicated more than 95% of red drum were recaptured within 125 miles of their release location, even after five or more (up to 18) years at large. Of 12,754 tags with known recapture locations, 79 were recaptured in North Carolina, 12,657 in South Carolina, 13 in Georgia and 5 in Florida (SEDAR 2009b).

This analysis was updated in the current benchmark assessment using tagging data through 2021, finding broadly similar results when considering a much larger ( $n = 47,520$ ) sample size of recaptured fish with known recapture locations. Of these, 99.7% ( $n = 47,376$ ) were recaptured in South Carolina with only 144 (0.3%) recaptured in neighboring states: 83 recaptured in North Carolina, 31 in Georgia, 29 in Florida, and 1 in New Jersey. These patterns held when considering only recaptures of adult ( $> 750$  mm total length (TL);  $n = 6,905$ ) fish, with 99.8% ( $n = 6,890$ ) being recaptured in South Carolina. Further, looking at cumulative percentage recaptured as a function of straight-line distance, regardless of age, most were recaptured within 50 km of their original tagging location with only 147 fish recaptured  $>150$  km (maximum 467 km) from their original tagging location, though there was a tendency for larger distances moved with age (Figure 5).

The genetic work by SCDNR also suggests some movement of adult red drum between SC and NC during non-spawning seasons. However, these adult fish do appear to return to their respective stock during the spawning season.

### **2.3 Age and Growth**

Age data available for red drum along the Atlantic coast of the U.S. were collected, processed, read, and supplied by each of the state's agencies and academic institutions from Virginia through Florida. Otoliths are the primary ageing structure collected from red drum. They produce clearly interpretable annual growth bands and the age estimates have been shown to be precise (ASMFC 2008) and considered highly accurate. In contrast, age estimates from scales are only considered accurate through age-4 (ASMFC 2008), though a preliminary paired study from SCDNR suggested biased age determinations using scales began manifesting as early as age-3 ( $n = 519$ ; Figure 6; J. Ballenger, SCDNR, pers. comm.). This study found an absolute agreement of only 83% and a significant bias in scale ages (relative to otolith derived ages) as indicated by Bowker's symmetry test and other tests. Hence, the SAS recommended discarding scale derived age estimates from consideration in the current assessment. Additional details on age processing and reading are available in SEDAR 2015a.

A total of 71,355 otoliths were assigned ages for red drum from years 1981 – 2022 (Table 5). The vast majority of aged-fish were 0 to 2 years old (91%) and ages 0 –5 comprised 95% of the data (Table 5).

Age data for red drum from the northern stock constituted 57.9% ( $n = 41,301$  otoliths) and the southern stock 42.1% ( $n = 30,054$  otoliths; Table 6, Figure 7a). The number of ages sampled annually by stock was very low in the early 1980s but began increasing in the mid-1980s through the late 2010s where it peaked at greater than 3,000 samples annually. Since, the total number of age samples collected annually began decreasing through 2022 and were likely impacted by COVID-19 during years 2020 – 2021 though greater than five hundred individuals have been aged annually every year since 1986. North Carolina provided 55.9% ( $n = 39,885$  otoliths) of samples, followed by South Carolina (28%;  $n = 19,949$  otoliths), Georgia (8.7%;  $n = 6,241$ ), Florida (5.4%,  $n = 3,864$ ), and Virginia (1.9%;  $n = 1,330$ ; Table 6, Figure 7b).

Ages sampled from the fishery-independent sources ( $n = 53,948$  otoliths; Table 7, Figure 8) constituted 75.7% of all ages, while ages sampled from fishery dependent sources ( $n = 17,347$  otoliths; Table 7, Figure 8) made up 24.3%.

### 2.3.1 Maximum Age

The current maximum observed age of red drum based on sectional otoliths is 62 years in the northern stock and 41 years in the southern stock, unchanged from the previous assessment.

### 2.3.2 Growth

Length-at-age data were restricted to ages based on otoliths and containing complete information on year, month, state, fishery, and length. Total length observations were grouped by calendar age per stock and iteratively Z-scored; outliers were removed using threshold values of  $\pm 8$  in the first iteration and values of  $\pm 4$  in the second iteration. Calendar ages were converted to biological (i.e., fractional monthly) ages using an assumed birthdate of September 1.

Red drum length-at-age displayed fast growth through ages 4 – 5 and fish from the northern stock grew to larger asymptotic lengths than the southern stock (Figure 9). Diminished samples of adults and older individuals can also be seen as red drum move out of the estuaries and to the offshore environment.

Red drum growth has long been understood to not be described well with some of the traditional growth models like the von Bertalanffy growth function (Porch et al. 2002; Cadigan 2009). There are strong seasonal influences on growth as well as indications of changing growth rates over the age range of the stocks that result in poor fits with traditional growth functions. Alternative growth estimates are available (Porch et al. 2002; Cadigan 2009), as well as empirical estimates of length-at-age, but these options are not compatible with growth options in the SS framework used in this assessment and the prior simulation assessment (ASMFC 2022).

Therefore, an alternative growth function that allows for changing the von Bertalanffy growth coefficient parameters ( $K$ ) across ages (Methot et al. 2023; age-varying  $K$  growth) was used to generate stock-specific growth patterns. The growth function includes the traditional von Bertalanffy growth parameters for asymptotic length ( $L_{inf}$ ) and the growth coefficient ( $K_{base}$ ), but also allows for multipliers of the  $K$  parameter at user-specified older ages thereby giving flexibility to the growth curve. The  $K_{base}$  parameter is used in growth calculations for the youngest age (here, age-0) and any subsequent ages until an age break point where a  $K$  multiplier is specified. At this age break point, the multiplier is applied to the  $K_{base}$  and the product serves as the new  $K$  parameter for any subsequent ages unless another age break point is specified. If another age break point is specified, the associated  $K$  multiplier is applied to the  $K$  parameter and the product becomes the new  $K$  parameter. This repeats for any age break points across the age range. The number of  $K$  multipliers can range from one to one less than

the number of ages in the age range. The parameterization of the von Bertalanffy growth function used here also includes a parameter for the length ( $L_{min}$ ) at a user-specified minimum age ( $A_{min}$ ) when fish begin to grow according to the growth function. In addition to the von Bertalanffy growth curve describing expected mean length-at-age, the models use coefficients of variation (CVs) for size at the smallest sizes and the largest sizes in the growth function with interpolation of CVs between these sizes to describe variation in growth around the expected growth curve.

To estimate at what ages these break points would occur, data by stock were first summarized into mean lengths-at-age. Next, segmented regression using the R (R Core Team 2024) package “segmented” (Muggeo 2017) was applied to the biological mean length-at-age data to identify the age break points. This method utilizes iterative procedure algorithms and requires starting values for the break point parameters. Studies in life history theory suggest changes in growth rate can occur in connection with physiological processes, such as maturity onset; therefore, age-at-50% maturity ( $A_{50}$ ) values were used as initial starting values to approximate onset of maturity (Scott and Heikonen 2012; Baulier and Heino 2008). Segmented regression models were explored using both one break and two breaks and models were compared using AIC. For both stocks, the model which identified two breaks had the lower AIC value. In the northern stock, break points were identified for ages 2.06 and 6.35 years (Figure 10a) while in the southern stock, break points were identified for ages 1.26 and 6.19 years (Figure 10b).

Lastly, an age-varying  $K$  growth model was constructed in Microsoft Excel for each stock in an effort to replicate how the length-at-age data are internally modeled within the SS framework using the age-varying  $K$  growth model option. The model was set-up using biological age, the associated mean length of that age, growth parameters (i.e.,  $L_{inf}$ ,  $K_{base}$ , and the  $K$  multiplier parameters), and the predicted length for each biological age. The break points estimated in the segmented regressions were applied to the  $K$  multipliers of the biological monthly age closest to that value (e.g., age 2.06 becomes age 2.08 and age 6.35 becomes age 6.25). Residual sum of squares (RSS) were calculated between the observed and predicted values and Excel’s Solver function was utilized to minimize the RSS by changing the  $L_{inf}$ ,  $K_{base}$ , and the  $K$  multiplier parameters. Model AIC was then calculated as  $N * \ln\left(\frac{RSS}{N}\right) + 2(K + 1)$  where  $N$  is the number of mean length-at-age observations, RSS is the residual sum of squares, and  $K$  is the number of parameters in the model.

For the northern stock, the best fitting age-varying  $K$  growth model estimated parameters  $L_{inf} = 1,253$  mm,  $K_{base} = 0.259$ ,  $K_{mult1} = 0.909$  at age 2.083 (corresponding  $K = 0.235$ ), and  $K_{mult2} = 0.197$  at age 6.250 (corresponding  $K = 0.046$ ; Figure 11). For the southern stock, age-varying  $K$  growth model estimated parameters  $L_{inf} = 1,132$  mm,  $K_{base} = 0.296$ ,  $K_{mult1} = 0.731$  at age 1.250 (corresponding  $K = 0.216$ ), and  $K_{mult2} = 0.192$  at age 6.167 (corresponding  $K = 0.041$ ; Figure 12). The SAS used these parameter as starting values for the age-varying  $K$  growth model option within SS for each respective stock.

This methodology also represents a change from how the age-varying  $K$  growth model was implemented for the operating model of the simulation assessment (ASMFC 2022) and is

considered more objective and parsimonious. Age breaks were identified through modeling of changes in mean length-at-age and the number of age breaks were reduced from five (northern) and four (southern) to two. However, more work is needed on this growth model than the time that was available during this assessment. For example, it would be beneficial to build this model within a framework (e.g., R or ADMB) that would allow for a bootstrapping routine to estimate the variances of each parameter.

## **2.4 Reproduction**

Herein the SAS reports on the understanding of red drum reproduction, based on peer-reviewed studies, previous assessments, and data submitted by data providers for the current benchmark stock assessment. Some of the data submitted for the current assessment represent gross sex and maturity assessments based on macroscopic examination of gonadal structures in sacrificed fish. Preliminary analysis looking at size- and/or age-based maturity patterns using this macroscopically derived information suggested severe bias in maturity ogives and a conflict with histologically derived information. Previous paired comparisons at the SCDNR suggested substantial disagreement between macroscopically and microscopically derived maturity states (J. Ballenger, pers. comm.; Wenner 2000) and histologically derived maturity information is generally considered best available science (Brown-Peterson et al. 2011; Wilson & Nieland 1994). As such, any updated analyses for reproductive information conducted as part of this assessment relied solely on histologically derived data. This histologically derived information is supported by hydroacoustic data (Lowerre-Barbieri et al. 2008). Due to limited availability of data from the Atlantic coast region, where necessary (e.g., fecundity estimates) we incorporated data from Gulf of Mexico red drum populations.

### **2.4.1 Spawning Seasonality**

Spawning seasonality is consistent, if with a slight latitudinal cline (shifted slightly later further South), throughout the species range in the Gulf of Mexico and along the Atlantic coast of the US. For fish found at the lowest latitudes along the Gulf and Atlantic coasts of Florida, the spawning season peaks between September and October (Murphy and Taylor 1990). Westward along the northern Gulf of Mexico spawning occurs between mid-August to September. Along the Atlantic coast, hydroacoustic data suggests red drum congregate and spawn between August and mid-October along coastal Georgia (Lowerre-Barbieri et al. 2008) and based on histological data spawn from mid-August to September along coastal South Carolina (J. Ballenger, pers. comm.). Along the coast of North Carolina, spawning peaked between August and September based on GSI and hydroacoustic data (Ross et. al. 1995; Luczkovich et al. 1999). In combination, these studies are indicative of a spawning season generally between August and October, with a 45–60-day season in a given location.

### **2.4.2 Sexual Maturity**

Previously published information on red drum maturity was available from North Carolina, South Carolina, the Florida Atlantic coast (Indian River Lagoon) and Florida Gulf of Mexico coast. In Florida, using specimens collected from both Tampa Bay and the Indian River Lagoon,

Murphy & Taylor (1990) suggested sexual differences in maturity rates, with females maturing at larger sizes (550-899 mm FL) and older ages (3-6 years old) than males (350-799 mm FL; ages 1-3). Interpolated lengths of 50% maturity for males and females in Tampa Bay were 529 mm and 825 mm FL, respectively (Murphy & Taylor 1990). Similarly, in the Indian River Lagoon along the Atlantic coast length-at-50% maturity for males and females was interpolated as 511 mm and 900 mm FL, respectively (Murphy & Taylor 1990). Sexually dimorphic maturity patterns were also noted in South Carolina, with histological analysis suggesting females matured at larger sizes (691-840 mm total length (TL)) and ages (3-5 years old) than males (573-785 mm TL; ages 2-3; Wenner 2000). This study found all females and males were mature by 5 and 4 years old, respectively, with calculated sizes- and ages-at-50% maturity of 792 mm TL and 4.3 years old for females and 713 mm TL and 3.5 years old for males (Wenner 2000). Ross et al. (1995) investigated the maturity of red drum in North Carolina, finding females and males attained 100% maturity by ages 4 and 3, respectively, with ages of first maturity of 3 and 2. Unsexed immature red drum ranged in size from 250-627 mm TL and 0-1 years old, while the smallest mature female was 773 mm TL and male was 520 mm TL (Ross et al. 1995). Lengths-at-50%-maturity were estimated to be 801-820 mm TL and 621-640 mm TL for females and males, respectively, with 57% of age-3 females and >50% age-2 males being mature (Ross et al. 1995). The Ross et al. (1995) study also noted senescence in two old females (ages 49 and 51), with ovaries severely atrophied and oogenic tissue absent, though five other old females (ages 40-52) were spent or resting.

During SEDAR 44, additional analyses were performed using data available from South Carolina (n = 5,540 fish; Arnott 2015a) and a re-analysis of the Ross et al. (1995) data (n = 728 fish) using Brown-Peterson et al. (2011) methodologies so that maturity could be statistically compared between North Carolina and South Carolina. The analyses found significant differences between North Carolina and South Carolina in relationships between both maturity-at-size and maturity-at-age, as well as significant differences between males and females. Based on results of this updated analysis, maturity-at-age was calculated separately for the northern and southern stocks in SEDAR 44 (ASMFC 2017b), a departure from previous assessments which relied on maturity estimates from Ross et al. (1995).

During the current assessment, maturity ogives were again re-assessed using updated histological maturity assessments available from South Carolina (analysis in previous assessment used a mix of macroscopic and histologically derived maturity information for the southern stock), North Carolina (Ross et al. 1995 data plus new data from NCDMF study), and to reflect our fishing year definition (September 1 – August 31) and assumed September 1 birthdate in the current assessment. Best fit logistic size- and age-at-maturity ogives are provided in Table 8 and Table 9, respectively, along with ogives used in SEDAR 44. Lengths-at-50% maturity for females slightly decreased relative to SEDAR 44 in both stocks with the addition of new data, with 50% maturity at 766 mm (95% CI: 753-778 mm TL) and 836 mm (95% CI: 818-853 mm TL) TL for the southern and northern stocks, respectively (Table 8, Figure 13 and Figure 14). Similarly, the ages-at-50% maturity for females slightly decreased relative to SEDAR 44 in both stocks with the addition of new data and shift in year determination and subsequent fractional age assignment, with 50% maturity at 4.2 (95% CI: 4.0-4.4 yrs) and 3.5

(95% CI: 3.4-3.7 yrs) years for the southern and northern stocks, respectively (Table 9, Figure 15 and Figure 16). Predicted lengths- and ages-at-maturity from SEDAR44 and the current assessment are provided in Table 10 and Table 11, respectively. Note the pronounced shift with a higher proportion of mature fish at a younger age is primarily driven by our change in the definition of year (September 1 – August 31 vs. January 1 – December 31) and assumed birthday (September 1 vs. January 1) in the current assessment relative to SEDAR44; these changes in assumptions did not and was not expected to have a similar effect on length-at-maturity estimates.

### **2.4.3 Sex ratio**

Most literature supports the assumption of a 1:1 sex ratio for the red drum population. For example, along the Atlantic coast in North Carolina Ross et al. (1995) found a 1:1 (349 males:373 females) sex ratio. In the northern Gulf of Mexico, the sex ratio for spawning adults was also 1:1 (Wilson & Nieland 1994). The one dissenting study is from South Carolina, where they found sex ratios differed from 1:1 overall and within different gears and locations (Wenner 2000). They observed an overall sex ratio of 0.80:1 females:males across all data. In estuarine waters, where 95% of all individuals sampled were juveniles, they observed a sex ratio of 0.76:1 females:males; the pattern switched for adults where the ratio was 1.62:1 females:males.

Given the two studies reporting a 1:1 sex ratio and the differences in sex ratio by location in South Carolina, we recommended to assume a 1:1 sex ratio for the current assessment. This is consistent with previous assessments in the region.

### **2.4.4 Spawning Frequencies**

For the current assessment, histologically derived reproductive stage information available from South Carolina for adult female red drum captured from mid-August through September was used to investigate spawning frequencies of adult red drum along the Atlantic coast ( $n = 168$  mature females). The probability of spawning on a given day was calculated as the proportion of females actively spawning (Brown-Peterson et al. 2011) divided by the number of mature females encountered, with a probability of spawning using the combined data set of 29.8% (Table 12). This equates to a spawning frequency (Spawning Frequency =  $1/\text{probability of spawning}$ ) of approximately 3.4, which in turn equates to approximately 13.4 spawns (# of spawns = spawning season/spawning frequency) over a 45-day spawning season (Table 12). These new estimates from the Atlantic coast were consistent with estimates available from the northern Gulf of Mexico, where Wilson & Nieland (1994) estimated a spawning frequency of females of every 2 to 4 days.

### **2.4.5 Spawning Location**

Spawning most likely occurs in the nearshore areas adjacent to channels and passes and may also occur over nearshore continental shelves (Murphy and Taylor 1990; Lowerre-Barbieri et al. 2008). Spawning locations in South Carolina were also associated with passes and channels (Wenner 2000). More recent evidence suggests that, in addition to nearshore vicinity habitats,

red drum also utilize high-salinity estuarine areas along the coast (Murphy and Taylor 1990; Johnson & Funicelli 1991; Nicholson and Jordan 1994; Woodward 1994; Luczkovich et al. 1999; Beckwith et al. 2006).

#### **2.4.6 Batch Fecundity**

Batch fecundity estimates vs. fork length (FL), gonad-free body weight, age in year, and eviscerated body weight were generated by Wilson and Nieland (1994) for red drum from the northern Gulf of Mexico from 1986 to 1992. The mean batch fecundity was 1.54 million ova. Fish ranged from 3-33 years of age, had a FL range of 697-1005 mm, and a batch fecundity range of 0.16-3.27 (ova x 10<sup>6</sup>).

Data on batch fecundity for the current assessment was made available from a Florida Fish and Wildlife Research Institute study conducted in 2008 in Tampa Bay. Fish (n = 143) ranged from 5-22 years of age, 833-1072 mm TL, 5,615-12,475 g wet weight, and a batch fecundity of 0.10-4.58 (ova x 10<sup>6</sup>; S. Burnsed, pers. comm.). The strongest relationship was between batch fecundity and TL, using the linear regression  $Fec = 7,172,211 * \log(TL) - 46,549,889$  (R<sup>2</sup> = 0.21; Figure 17).

However, a drawback to this data set was its geographic location (Tampa Bay, FL in the Gulf of Mexico) and the lack of smaller mature females (smallest female 833 mm TL; larger than Atlantic length-at-50%-maturity) necessitating extrapolation beyond the range of the data if used in the current assessment.

As such, though a preliminary investigation of reproductive potential-at-age was calculated using information on female proportion mature-at-age, batch fecundity-at-age, and number of spawns-at-age to calculate annual fecundity-at-age, the SAS decided to continue use of female spawning stock biomass (calculated using only female maturity-at-age) as a proxy for reproductive potential. Future work is needed to collect batch fecundity estimates from the Atlantic coast stocks and to investigate spawning frequency across spatial areas and age.

#### **2.4.7 Recruitment Drivers**

In 2020, Goldberg et al. published an analysis of North Carolina young-of-year red drum data through 2016 that identified a relationship between year class strength and environmental variables. Specifically, the analysis found earlier shifts to favorable coastal wind conditions (summed hourly wind speeds of winds blowing towards the coast) in late August was the most consistent environmental feature associated with recruitment success. Favorable winds in early October and across the recruitment season (late July through early October) were also found to be significant variables explaining recruitment success. Elevated late July average sea surface temperature (SST) was found to be an additional significant driver of recruitment success and positive associations were found between recruitment and chlorophyll concentrations, though it was noted that more spatially resolved chlorophyll concentration data are needed.

These relationships were evaluated here with updated data and expanded to areas in the southern red drum stock as exploration of a potential recruitment covariate data stream for



assessment models. Environmental data were updated through 2022 from the same climate stations used by Goldberg et al. 2020 (North Carolina State Climate Office station KHSE for wind and NOAA National Data Buoy Center Stations DSLN7 and 41025 for SST) and two new stations identified in South Carolina (NOAA National Data Buoy Center Station 41004 southeast of Charleston) and Georgia (NOAA National Data Buoy Center Station 41008 southeast of Savannah) coastal waters. The same recruitment index used by Goldberg et al. 2020 (North Carolina Bag Seine Survey fall age-0 index) was used for analysis of North Carolina recruitment. The South Carolina Trammel Net Survey age-1 index lagged back one year and the Georgia Gill Net Survey age-0 fishing year index were used for analyses of southern stock recruitment.

Relationships between indices of abundance and environmental indices were examined with correlation analysis given the linear relationship between recruitment and wind and SST indices suggested in the original study. Environmental indices were developed in bi-weekly (early and late month periods), monthly, and seasonal temporal scales as done previously (Goldberg et al. 2020) to determine if any of the various temporal scales were more important for recruitment success. Favorable wind indices used the same wind directions for all three stations (winds originating from the N, NE, E, SE). SST data were only analyzed for North Carolina and not South Carolina or Georgia given preliminary results for North Carolina indicated a lack of support for a relationship between recruitment and SST. Regression models including surrounding stations (NOAA National Data Buoy Center Stations 41002 and 44014) Goldberg et al. 2020 used to gap-fill missing SST data for the stations used in the analysis (DSLN7 and 41025) were updated with additional years of data and used for gap-filling in this analysis as well. Given the data limitations and weaker support for chlorophyll concentrations, these data were not used in this analysis.

Correlation results between North Carolina favorable wind and recruitment indices for the same time series used by Goldberg et al. 2020 were significant ( $p$ -value $<0.05$ ) for the same temporal periods significant in the original study (late August, early October, and seasonal; Table 13). These results held for the early October and seasonal indices using the update time series, but not the late August index. The recruitment index and seasonal wind index both show higher average levels at the beginning of the time series followed by stable and variable indices since around 2000 (Figure 18). No significant correlations were found between recruitment and SST indices (Table 14).

There are limitations of wind data for the South Carolina buoy, precluding comparison of indices for the 1990–1999-year classes, except 1997 (Figure 19). However, correlation results do indicate a positive correlation between the SC recruitment index and the early September favorable wind index from this buoy (Table 15). Both indices show sharp declines in 2010 with continued low values through the early to mid-2010s (Figure 19). The wind index does show improvement in wind conditions since 2017 that is not reflected in the recruitment index. This may be indicative of fishing impacts on the population or other environmental drivers controlling recruitment.

Only marginally significant ( $p$ -value $<0.1$  and  $>0.05$ ) positive correlations were detected for the Georgia recruitment index and wind indices from the Georgia buoy (Table 15). The recruitment index is not available prior to 2002, which is a period when there were higher favorable wind index values. Comparison of the recruitment index with the wind index with the strongest marginally significant correlation (early August) show both indices are highly variable, but the wind index declines to lower levels in the late 2000s, while the recruitment index only declines to lower levels for a short period in the early 2010s (Figure 20).

All combinations of wind indices and recruitment indices in the southern stock were compared, and significant or marginally significant positive correlations were only found between recruitment indices and wind indices from the same state, indicating some localized spatial coherence in these trends (Table 15).

Although significant, positive correlations were detected between recruitment indices and wind indices, these correlations were generally weak ( $r<0.5$ ) or need some approach to spatial aggregation (southern stock) due to lack of broader spatial correlation. This limits the utility of wind indices as an environmental variable to predict recruitment in the assessment models on their own. This is likely due to recruitment driver mechanisms being complex and influenced by a number of abiotic and biotic (e.g., red drum SSB, red drum juvenile prey availability) factors. The wind indices analyzed here provide a starting point for identifying these mechanisms and continuing this work in future stock assessments.

## 2.5 Natural Mortality

Natural mortality,  $M$ , characterizes all causes of natural (i.e., non-fishing) mortality such as predation, starvation, disease, and senescence (Gulland 1983; Hilborn and Walters 1992) but may also include some forms of human-induced mortality not due to fishing (Maunder et al. 2023). While it is one of the most influential parameters within fisheries stock assessment, it is rarely observed or measured in fish populations; consequently, it is difficult to estimate and remains a large source of uncertainty within most assessment models (Vetter 1988, Hampton 2000, Maunder et al. 2023).  $M$  is commonly treated as a constant within stock assessment processes and textbooks (e.g., Hilborn and Walters 1992; Quinn and Deriso 1999; Haddon 2011), but application as a size-dependent or equivalent age-dependent function using a stock-specific growth function with constant  $M$  scaled to a fully selected age or range of ages (e.g., the ‘Lorenzen  $M$ ’ model) is becoming more commonly practiced in stock assessments conducted in the southeastern United States (Lorenzen 2022; Lorenzen et al. 2022).

Constant as well as size- and age-dependent estimates of natural mortality of red drum were explored using the approaches and recommendations presented in the recent review of natural mortality estimation methods by Maunder et al. (2023) and the ‘generalized length-inverse mortality (GLIM)’ paradigm presented by Lorenzen (2022). Where relevant, all natural mortality models assumed a von Bertalanffy growth parameterization where the growth coefficient,  $K$ , was allowed to vary by age. Constant  $M$  estimates were calculated based on the longevity model updated by Hamel and Cope (2022) where  $M = 5.4/t_{max}$  and  $t_{max}$  represents the

maximum age for each stock. These estimates of constant  $M$  were then converted to mortality-at-length and -age using the mortality-weight model described in Lorenzen (1996) where  $M_w = 3 * W^{-0.288}$  and the length-inverse model described in Lorenzen (2022) where  $M_L = M_{Lr}(L/L_r)^c$ . For the length-inverse model, the Hamel and Cope (2022) longevity-based estimate of constant  $M$  was used as the mortality at reference age and scaled so that the cumulative mortality rate predicted for ages 2 and greater agreed with the constant  $M$  estimate. For the mortality-weight model, the age-specific estimates were scaled following Hewitt and Hoenig (2005) where percent survival was equal to  $100 * e^{-M * t_{max}}$ .

Longevity estimates for red drum in the northern stock was  $t_{max} = 62$  years while in the southern stock it was  $t_{max} = 41$  years. The von Bertalanffy growth parameter values were based on the final growth models selected (Section 2.3.2) where  $L_{inf} = 1,253$  mm,  $K_{base} = 0.259$ ,  $K_{age2} = 0.235$ , and  $K_{age6} = 0.046$  for the northern stock and  $L_{inf} = 1,132$  mm,  $K_{base} = 0.296$ ,  $K_{age1} = 0.216$ , and  $K_{age6} = 0.041$  for the southern stock. Length-weight model parameters of red drum used within the mortality-weight model were obtained from the non-linear length-weight model converting maximum total length (mm) to total weight (g) where  $a = 1.65E-5$  and  $b = 2.931$  for the northern stock and  $a = 1.13E-5$  and  $b = 2.983$  for the southern stock. Constant mortality estimates based on the longevity model were found to be  $M = 0.087$  in the northern stock and  $M = 0.132$  in the southern stock.

Estimated mortality-at-age from the mortality-weight model ranged from  $0.349 - 0.038 \text{ yr}^{-1}$  in the northern stock and from  $0.517 - 0.104 \text{ yr}^{-1}$  in the southern stock (Table 16; Figure 21) where cumulative survival to the oldest age class was 0.49% and 0.50%, respectively. The length-inverse model estimated mortality-at-age from  $0.498 - 0.079 \text{ yr}^{-1}$  in the northern stock and from  $0.749 - 0.116 \text{ yr}^{-1}$  in the southern stock (Table 16; Figure 21) where cumulative survival to the oldest age class was 0.26% and 0.20%, respectively.

The SAS recommended estimates of natural mortality be size- or age-dependent and recommended the Lorenzen (2022) length-inverse model be used to inform natural mortality within the stock assessment models.

### **3 HABITAT DESCRIPTION**

Habitat information for red drum is summarized from a comprehensive report on sciaenid species habitat information completed by the ASMFC (Odell et al. 2017). See this report for additional detail on red drum habitat. In addition, fish habitat of concern (FHOC) designations for red drum were published by the ASMFC Habitat Committee in 2024 (ASMFC 2024).

#### **3.1 Spawning, Egg, and Larval Habitat**

##### Spawning Habitat

Red drum spawn from late summer to late fall in a range of habitats, including estuaries, and near inlets, passes, and bay mouths (Peters and McMichael 1987). Earlier studies illustrated spawning occurred in nearshore areas relative to inlets and passes (Pearson 1929; Miles 1950;

Simmons & Breuer 1962; Yokel 1966; Jannke 1971; Setzler 1977; Music & Pafford 1984; Holt et al. 1985). More recent evidence suggests red drum also use high-salinity estuarine areas along the coast for spawning (Murphy & Taylor 1990; Johnson & Funicelli 1991; Nicholson and Jordan 1994; Woodward 1994; Luczkovich et al. 1999; Beckwith et al. 2006; Renkas 2010). Several authors provide direct evidence of red drum spawning deep within estuarine waters of the IRL, Florida (Murphy & Taylor 1990; Johnson & Funicelli 1991). An intensive two-year ichthyoplankton survey consistently collected preflexion (2–3 mm) red drum larvae up to 90 km away from the nearest ocean inlet from June to October with average nightly larval densities as high as fifteen per 100 m<sup>3</sup> of water in the IRL (Reyier and Shenker 2007). Acoustic telemetry results for large adult red drum in the IRL further support estuarine spawning of this species within the IRL system (Reyier et al. 2011).

Spawning in laboratory studies have also appeared to be temperature-dependent, occurring in a range from 22° to 30°C but with optimal conditions between temperatures of 22° to 25°C (Holt et al. 1981). Renkas (2010) duplicated environmental conditions of naturally spawning red drum from Charleston Harbor, SC in a mariculture setting, and corroborated that active egg release occurred as water temperature dropped from a peak of ~30° C during August. Cessation of successful egg release was found at 25°C, with no spawning effort found at lower temperatures (Renkas 2010). Pelagic eggs, embryos, and larvae are transported by currents into nursery habitats for egg and larval stages, expectedly due to higher productivity levels in those environments (Peters & McMichael 1987; Beck et al. 2001).

### Eggs and Larvae Habitat

Researchers commonly encounter red drum eggs in southeastern estuaries in high salinity, above 25 ppt (Nelson et al. 1991; Reyier & Shenker 2007; Renkas 2010). Salinities above 25 ppt allow red drum eggs to float while lower salinities cause eggs to sink (Holt et al. 1981). In Texas, laboratory experiments conducted by Neill (1987) and Holt et al. (1981) concluded that an optimum temperature and salinity for the hatching and survival of red drum eggs and larvae was 25°C and 30 ppt. Spatial distribution and relative abundance of eggs in estuaries, as expected, mirrors that of spawning adults (Nelson et al. 1991); eggs and early larvae utilize high salinity waters inside inlets, passes, and in the estuary proper. Currents transport eggs and pelagic larvae into bays, estuaries, and seagrass meadows (when present), where they settle and remain throughout early and late juvenile stages (Holt et al. 1983; Pattillo et al. 1997; Rooker & Holt 1997; Rooker et al. 1998; Stunz et al. 2002).

Larval size increases as distance from the mouth of the bay increases (Peters & McMichael 1987), possibly due to increased nutrient availability. Research conducted in Mosquito Lagoon, Florida, by Johnson & Funicelli (1991) found viable red drum eggs being collected in average daily water temperatures from 20°C to 25°C and average salinities from 30 to 32 ppt. During the experiment, the highest numbers of eggs were gathered in depths ranging from 1.5 to 2.1 m and the highest concentration of eggs was collected at the edge of the channel.

Upon hatching, red drum larvae are pelagic (Johnson 1978) and laboratory evidence indicates development is temperature-dependent (Holt et al. 1981). Newly hatched red drum spend

approximately twenty days in the water column before becoming demersal (Rooker et al. 1999; FWCC 2008). However, Daniel (1988) found much younger larvae already settled in the Charleston Harbor estuary. Transitions are made between pelagic and demersal habitats once settling in the nursery grounds (Pearson 1929; Peters and McMichael 1987; Comyns et al. 1991; Rooker & Holt 1997). Tidal currents (Setzler 1977; Holt et al. 1989) or density-driven currents (Mansueti 1960) may be used in order to reach a lower salinity nursery in upper areas of estuaries (Mansueti 1960; Bass & Avault 1975; Setzler 1977; Weinstein 1979; Holt et al. 1983; McGovern 1986; Peters & McMichael 1987; Daniel 1988; Holt et al. 1989). Once inhabiting lower salinity nurseries in upper areas of estuaries, red drum larvae grow rapidly, dependent on present environmental conditions (Baltz et al. 1998).

Red drum larvae along the Atlantic coast are common in southeastern estuaries, except for Albemarle Sound, and are abundant in the St. Johns and IRL estuaries in Florida (Nelson et al. 1991). Daniel (1988) and Wenner et al. (1990) found newly recruited larvae and juveniles through the Charleston harbor estuary over a wide salinity range. Mercer (1984) has also summarized spatial distribution of red drum larvae in the Gulf of Mexico. Lyczkowski-Shultz & Steen (1991) reported evidence of diel vertical stratification among red drum larvae found at lower depths less than 25 m at both offshore and nearshore locations. Larvae (ranging between 1.7 to 5.0 mm mean length) were found at lower depths at night and higher in the water column during the day. At the time of the study, the water was well mixed and the temperature ranged between 26° and 28°C. There was no consistent relationship between distribution of larvae and tidal stage. Survival during larval (and juvenile) stages in marine fish, such as the red drum, has been identified as a critical bottleneck determining their contribution to adult populations (Cushing 1975; Houde 1987; Rooker et al. 1999).

### **3.2 Juvenile and Adult Habitats**

#### **Juvenile Habitat**

Juvenile red drum use a variety of inshore habitats within the estuary, including seagrass meadows (where they exist), tidal freshwater, low salinity reaches of estuaries, estuarine emergent wetlands, estuarine scrub/shrub, submerged aquatic vegetation, oyster reefs, shell banks, and unconsolidated bottom (SAFMC 1998; Odell et al. 2017). Smaller red drum seek out and inhabit rivers, bays, canals, boat basins, and passes within estuaries (Peters and McMichael 1987; FWCC 2008). Wenner (1992) indicated red drum juvenile habitats vary slightly seasonally; most often between August and early October red drum inhabit small creeks that cut into emergent marsh systems and have some water in them at lower tides, while in winter, red drum reside in main channels of rivers ranging in depths from 10 to 50 feet (3-15 m) with salinities from one-half to two-thirds that of seawater. In the winter of their first year, 3- to 5-month-old juveniles migrate to deeper, more temperature-stable parts of the estuary during colder weather (Pearson 1929). In the spring, they move back into the estuary and shallow water environments. Studies show red drum inhabiting non-vegetated sand bottoms exhibit the greatest vulnerability to natural predators (Minello and Stunz 2001). Juvenile red drum in

their first year avoid wave action by living in more protected waters (Simmons and Breuer 1962; Buckley 1984).

In the Chesapeake Bay, juveniles (20-90 mm TL) were collected in shallow waters from September to November, but there is no indication as to the characteristics of the habitat (Mansueti 1960). Some southeastern estuaries where juvenile (and sub-adult) red drum are abundant are Bogue Sound, NC; Winyah Bay, SC; Ossabaw Sound, and St. Catherine/Sapelo Sound, GA; and the St. Johns River, FL (Nelson et al. 1991) and throughout SC (Wenner et al. 1990; Wenner 1992). They were highly abundant in the Altamaha River and St. Andrews/St. Simon Sound, GA, and the Indian River, FL (Nelson et al. 1991).

Peters and McMichael (1987) found juvenile red drum were most abundant in protected backwater areas, such as rivers, tidal creeks, canals, and spillways with freshwater discharge, as well as in areas with sand or mud bottom and vegetated or non-vegetated cover in Tampa Bay. Juveniles found at stations with seagrass cover were smaller in size and fewer in number (Peters and McMichael 1987). Near the mouth of the Neuse River, as well as smaller bays and rivers between Pamlico Sound and the Neuse River, surveys from the NCDMF indicate juvenile red drum were abundant in shallow waters of less than 5 feet (1.5 m). Habitats identified as supporting juvenile red drum in North Carolina can be characterized as detritus laden or mud bottom tidal creeks (in Pamlico Sound) and mud or sand bottom habitat in other areas (Ross & Stevens 1992). In a Texas estuary, young red drum (6-27 mm Standard Length, SL) were never present over non-vegetated muddy-sandy bottom; areas most abundant with red drum occurred in the ecotone between seagrass and non-vegetated sand bottom (Rooker & Holt 1997). In SC, Wenner (1992) indicated very small red drum occupy small tidal creeks with mud/shell hash and live oyster as common substrates (since sub-aquatic vegetation is absent in SC estuaries).

### Sub-Adult Habitat

The distribution of red drum within estuaries varies seasonally as individuals grow and begin to disperse. Along the South Atlantic coast, they use a variety of inshore habitats. Late juveniles leave shallow nursery habitats at approximately 200 mm TL (10 months of age). They are considered sub-adults until they reach sexual maturity at 3–5 years. It is at this life stage red drum use a variety of habitats within the estuary and when they are most vulnerable to exploitation (Pafford et al. 1990; Wenner 1992). Tagging studies conducted throughout the species' range indicate sub-adult red drum remain in the vicinity of a given area (Beaumarrige 1969; Osburn et al. 1982; Music & Pafford 1984; Pafford et al. 1990; Wenner et al. 1990; Ross & Stevens 1992; Woodward 1994; Marks & DiDomenico 1996; Adams & Tremain 2000; Troha 2023). Movement within the estuary is related to changes in temperature and food availability (Pafford et al. 1990; Woodward 1994).

Tagging studies indicate late age-0 and 1 year-old red drum are common throughout the shallow portions of the estuaries and are particularly abundant along the shorelines of rivers and bays, in creeks, and over grass flats and shoals of the sounds. During the fall, those sub-adult fish inhabiting the rivers move to higher salinity areas such as the grass flats and shoals of

the barrier islands and the front beaches. With the onset of winter temperatures, juveniles leave the shallow creeks for deeper water in the main channels of rivers (9–15 m) and return to the shallows in the spring. Fish that reside near inlets and along the barrier islands during the summer are more likely to enter the surf zone in the fall.

By their second and third year of growth, red drum are less common in rivers but are common along barrier islands, inhabiting the shallow water areas around the outer bars and shoals of the surf and in coastal inlets over inshore grass flats, creeks or bays. In the northern portion of the South Carolina coast, sub-adults use habitats of broad, gently sloping flats (up to 200 m or more in width). Along the southern part of the South Carolina coast, sub-adult red drum inhabit narrow (50 m or less), level flats traversed by numerous small channels, typically 5–10 m wide by less than 2 m deep at low tide (ASMFC 2002).

In general, habitats supporting juvenile red drum can be characterized as detritus or mud-bottom tidal creeks as well as sand and shell hash bottoms (Daniel 1988; Ross & Stevens 1992). Within seagrass beds, investigations show juveniles prefer areas with patchy grass coverage or sites with homogeneous vegetation (Mercer 1984; Ross & Stevens 1992; Rooker & Holt 1997). Wenner et al. (1990) collected post-larval and juvenile red drum in South Carolina from June 1986 through July 1988 in shallow tidal creeks with salinities of 0.8–33.7 ppt, although the preferred salinity range in the IRL, Florida is between 19–29 ppt (Tremain & Adams 1995).

#### Adult Habitat

Adults tend to spend more time in coastal waters after reaching sexual maturity. However, they continue to frequent inshore waters on a seasonal basis. Less is known about the biology of red drum once they reach the adult stage and accordingly, there is a lack of information on habitat utilization by adult fish. The SAFMC's Habitat Plan (SAFMC 1998) cited high salinity surf zones and artificial reefs as EFH for red drum in oceanic waters, which comprise the area from the beachfront seaward. In addition, nearshore and offshore hard/live bottom areas have been known to attract concentrations of red drum.

In addition to natural hard/live bottom habitats, adult red drum also use artificial reefs and other natural benthic structures. Red drum were found from late November until the following May at both natural and artificial reefs along tide rips or associated with the plume of major rivers in Georgia (Nicholson & Jordan 1994). Data from this study suggests adult red drum exhibit high seasonal site fidelity to these features. Fish tagged in fall along shoals and beaches were relocated 9–22 km offshore during winter and then found back at the original capture site in the spring. This would be supported by the high site fidelity of red drum recaptures in the SCDNR tagging programs, with an average distance moved of forty fish recaptured after 15+ years-at-large of 46 km (0.6 – 179 km; J. Ballenger, pers. comm.). In summer, fish moved up the Altamaha River 20 km to what the authors refer to as “pre-spawn staging areas” and then returned to the same shoal or beach again in the fall. Adult red drum inhabit high salinity surf zones along the coast and adjacent offshore waters, at full marine salinity. Adults in some areas of their range (e.g., IRL, FL) can reside in estuarine waters year-round, where salinities are variable.

### **3.3 Fish Habitat of Concern**

Fish habitat of concern (FHOC) designations for red drum were published by the ASMFC Habitat Committee in 2024 (ASMFC 2024) and are summarized herein. FHOC's varied based on life stage, with early juvenile FHOCs identified as protected marshes (tidal fresh, brackish, and salt water) and tidal creek habitat (Peters & McMichael 1987; Wenner 1992; FWCC 2008). While sub-adults use a wide range of estuary habitats, they exhibit the highest abundances and apparent productivity in association with submerged aquatic vegetation, oyster reef, tidal creeks, and marsh (tidally fresh, brackish, and salt) habitats (Pafford et al. 1990; Wenner 1992; Adams & Tremain 2000). FHOCs for adults include inlets, channels, sounds, outer bars, and within estuaries in some areas (e.g., Indian River Lagoon, FL) due to their importance for red drum spawning activity (Murphy & Taylor 1990; Johnson & Funicelli 1991; Reyier et al. 2011).

## **4 FISHERY-DEPENDENT DATA SOURCES**

Red drum fisheries are primarily recreational and, since the 1990s, exclusively so in the southern states (South Carolina, Georgia, Florida). Some commercial catch continues in northern states, but typically as bycatch in fisheries directed at other species. Fishery-dependent (FD) data are presented by fleet and stock designations. In the northern stock, most commercial and recreational catch comes from North Carolina waters, followed by Virginia, with low and variable catches north of Virginia. There have been similar regulation histories in North Carolina and Virginia, so northern stock fleets are aggregated catches from all states. There are two commercial fleets based on gear differences: a gill net and beach seine fleet (referred to as the North\_Commercial\_GNBS fleet in the assessment methods sections) and a fleet including catch from other commercial gears (primarily pound nets; referred to as the North\_Commercial\_Other fleet in the assessment methods sections). There is also a recreational fleet accounting for catch by recreational anglers using hook and line gear (referred to as the North\_Recreational fleet in the assessment methods sections). The three states in the southern stock have had different regulations through time and all regularly contribute to annual red drum catches. Past assessments have had time series starting after most of the commercial catch of red drum was phased out, so there are three recreational fleets accounting for catch by recreational anglers using hook and line gear in each of the three southern stock states (referred to as the SC\_Recreational, GA\_Recreational, and FL\_Recreational fleets in the assessment methods sections).

FD data sets considered during the assessment, but ultimately deemed not useful for deriving inputs for assessment approaches are described in Section 12.

### **4.1 Commercial Data**

#### **4.1.1 Data Collection and Treatment**

##### **4.1.1.1 Commercial Landings**

Historical commercial landings (1950 to present) for the Atlantic coast have been collected by state and federal agencies and are provided to the Atlantic Coastal Cooperative Statistics



Program (ACCSP) where they are maintained in the ACCSP Data Warehouse. The Data Warehouse was queried in May 2023 for all red drum landings (monthly summaries by state and gear category) from 1950 to 2022 for the east coast of Florida (Miami-Dade/Monroe County border), and all other Atlantic states. Gear categories were based on those used in SEDARs 18 and 44 and are based on knowledge of Atlantic coast red drum fisheries and reporting tendencies. The specific ACCSP gears included in each category can be found in Table 17. Landings from gear categories for the northern stock are aggregated into two groupings for presentation and use in this assessment based on expected similarities in selectivity among gears within each grouping and differences in selectivity between the two groupings. The first grouping includes the Beach Seine and Gill Nets SEDAR gear categories (North\_Commercial\_GNBS fleet) and the second grouping includes the Hook and Line, OTHER, Pound Net, Seine, and Trawls SEDAR gear categories (North\_Commercial\_Other fleet). Landings for the southern stock are aggregated by state, the structure of recreational fleets in this stock, for presentation and use in this assessment.

Landings data from ACCSP were reviewed and approved by state representative partners. In cases where discrepancies occurred, data directly from state databases was preferred to ACCSP Data Warehouse values. This included North Carolina data from 1994-2022 due to better gear allocation in NC trip ticket databases. Virginia harvester reports were used for 1993-2022 due to concerns on gear and area designations. New Jersey provided a custom data set for 2014-2022 containing catch used in direct sale from fishers. New York and Delaware both provided additional landing reports. Florida's commercial fishery ended in 1988, and between 1978 and 1988, reported gears are unreliable. Consistent with SEDAR 44, ACCSP staff extrapolated average gear proportions for Florida gears from 1962-1977 and applied those proportions to 1978-1988.

Preliminary commercial landings for the remainder of the 2022 fishing year that were not available during the original data query (January 2023-August 2023) were provided directly from state databases.

Landings data collection through time by states accounting for at least 1% of coastwide landings since 1950 are discussed below and are summarized for all Atlantic states in Figure 23 - Figure 26. A summary of the methodology used by individual states to obtain commercial landings data is available in Table 18, though more detailed information is provided in the following sections.

### Virginia

The National Marine Fisheries Service (NMFS) collected landings data for Virginia from 1950 through 1992. From 1973 to 1992, Virginia implemented a voluntary monthly inshore dealer reporting system, which was intended to supplement NMFS data. However, it was discovered that better inshore harvest data were required so the VMRC implemented a Mandatory Reporting Program (MRP) to collect Virginia commercial landings data that began January 1, 1993. The program currently is a complete census of all commercial inshore and offshore harvest in a daily format. Data collected are species type, date of harvest, species (unit and

amount), gear type, gear (amount and length), area fished, dealer, vessel (name and number), hours fished (man and gear), crew amount, and county landed.

In 2001, several fields listed above (gear length, man hours, vessel information: name and number, and crew amounts) were added to come in compliance with the ACCSP-identified critical data elements. Also, data collection gaps in the NMFS offshore collection program were identified and all offshore harvest that was not on a federally permitted species or sold to a federally permitted dealer was added to the MRP. The MRP reports are collected on daily trip tickets annually distributed to all commercially licensed harvesters and aquaculture product owners. All harvesters and product owners must report everything harvested and retained on the daily tickets. The daily tickets are put in monthly folders and submitted to VMRC. The monthly folders are provided by the VMRC and due by the 5<sup>th</sup> of the following month. Since 2022 these reports have also been made available to report electronically.

### North Carolina

The NMFS, prior to 1978, collected commercial landings data for North Carolina. Port agents would conduct monthly surveys of the state's major commercial seafood dealers to determine the commercial landings for the state. Starting in 1978, the NC DMF entered into a cooperative program with the NMFS to maintain the monthly surveys of North Carolina's major commercial seafood dealers and to obtain data from more dealers. The NC DMF Trip Ticket Program (NCTTP) began on 1 January 1994. The NCTTP was initiated due to a decrease in cooperation in reporting under the voluntary NMFS/North Carolina Cooperative Statistics Program in place prior to 1994, as well as an increase in demand for complete and accurate trip-level commercial harvest statistics by fisheries managers. The detailed data obtained through the NCTTP allows for the calculation of effort (i.e., trips, licenses, participants, vessels) in a fishery that was not available prior to 1994 and provides a much more detailed record of North Carolina's seafood harvest. Landings of red drum were calculated for North Carolina and reported in pounds (whole weight) broken down by month and gear categories used in past assessments. Data used to calculate the landings for North Carolina included landings from the NCTTP (1994 to 2023), landings from NMFS (1978 to 1993), and landings from historical data (prior to 1978). Prior to 1972, monthly landings were not recorded for North Carolina.

North Carolina also has landings from the recreational use of commercial gear allowed through the possession of a recreational commercial gear license (RCGL). This license allows for limited use of commercial gear to obtain fish for personal consumption. No sale is allowed with this license. Additionally, users must adhere to recreational bag limits. To estimate landings with this gear, North Carolina conducted a random survey of license holders from 2002 to 2007. Questionnaires were mailed to 30% of license holders each month. Information was obtained on locations fished, gears used, species kept and species discarded. A ratio of RCGL landings and commercial gillnet landings in overlapping years was used to estimate landings in years before and after the survey.

### South Carolina

Prior to 1972, commercial landings data were collected by federal fisheries agents based in South Carolina, either U.S. Fish and Wildlife Service or NMFS personnel. In 1972, South Carolina began collecting fishery landings data from coastal dealers in cooperation with federal agents using forms supplied by the SCDNR. These mandatory monthly landings reports were required from all licensed wholesale dealers in South Carolina. Until fall of 2003, those monthly reports were summaries collecting species, pounds landed, disposition (gutted or whole) and market category, gear type and area fished; since September 2003, landings have been reported by a mandatory trip ticket system collecting landings by species, disposition and market category, pounds landed, ex-vessel prices with associated effort data to include gear type and amount, time fished, area fished, vessel and fisherman information. Validation of landings is accomplished via dockside sampling.

At a minimum, South Carolina's trip-ticket program collects data on commercial effort, commercial catch, and economical value. Minimally, effort data includes gear types and quantity, location, and hours fished. Catch data includes species, disposition of catch, and quantity (pounds) landed. Finally economic data includes the wholesale price paid to fishermen.

Given commercial harvest of red drum has been prohibited in South Carolina since June 1987, the history of red drum landings in South Carolina are not very large particularly relative to other states, with the largest documented landings occurring the year the commercial fishery was shut down (14,689 pounds in 1987). Note, South Carolina has had some very small amount of reported illegal harvest (confidential) of red drum since their designation as a gamefish.

### Georgia

Prior to 1982, the NMFS and its predecessor agencies had been responsible for the collection of commercial fisheries landings data in Georgia. In 1982, with funding from NMFS, the Georgia Department of Natural Resources (GADNR) began collecting weekly and monthly commercial landings data from coastal Georgia. These included catch, area, effort, gear, value and associated data at various levels of detail depending on fishery and data needs. In 2001, Georgia implemented a trip ticket program in accordance with the minimum requirements set forth by the ACCSP partners. Additional data elements were added and the Georgia landings database was upgraded to meet the requirements. Trip level data are collected for all trips landing products in Georgia. Data collected include trip start and unloading dates, area fished, harvester and dealer, gear, species, market size, quantity, and value.

A small-scale gillnet fishery for red drum existed in the 1950s; however, the use of gillnets in Georgia's territorial waters was prohibited by statute in 1957. Since that time the commercial fishery for red drum was comprised predominately of hook and line recreational anglers and for-hire fishers that sell their catch. This catch was often sold directly to restaurants and not documented in commercial landings reporting. These landings are considered recreational (i.e., captured in the recreational catch survey – see Section 4.2.1) and all sale was restricted to the recreational bag limit. Red drum were granted game-fish status in 2013 thereby making commercial sale illegal.

## Florida

Commercial landings information was obtained from the FL FWC's Marine Fisheries Information System data and from the Fisheries Statistics Division of the NMFS for the years 1950 to 1988. No commercial landings have been reported for Florida since 1988 when the sale of native-caught red drum was prohibited.

Prior to 1986, landings of red drum were reported to the NMFS through monthly dealer reports made by major fish wholesalers in Florida. Since 1986, information on what is landed and by who in Florida's commercial fisheries comes from the FWC's Marine Resources Information System, commonly known as the trip-ticket program. Wholesale dealers are required to use trip tickets to report their purchase of saltwater products from commercial fishers. Conversely, commercial fishers must have Saltwater Products Licenses to sell saltwater products to licensed wholesale dealers. In addition, red drum became a "restricted species" in late 1987 so only fishers who had Restricted Species Endorsements on their Saltwater Products License qualified to sell red drum (though commercial fishing effectively ended shortly after this in 1989). Each trip ticket includes the Saltwater Products License number, the wholesale dealer license number, the date of the sale, the gear used, trip duration (time away from the dock), area fished, depth fished, number of traps or number of sets where applicable, species landed, quantity landed, and price paid per pound. During the early years of the program some data fields were deleted from the records, e.g., Saltwater Products License number for much of 1986, or were not collected, e.g., gear used was not a data field until about 1991.

The commercial fishery for red drum in Florida ended in 1989 when a 'no sale' provision was enacted into law.

### **4.1.1.2 Commercial Discards**

Currently, the only available data to describe commercial discards are from an observer program for the North Carolina estuarine gill net fishery for the period of 2004 to present. The North Carolina estuarine gill net fishery is presumed to be the primary culprit of commercial red drum discards in North Carolina as gill nets typically account for >90% of red drum commercial harvest. In previous assessments, discard estimates were calculated by area and season for both large and small mesh gill nets. Large mesh gill nets were defined as having a stretched mesh webbing of five inches or greater. CPUE was defined as the number (or weight) of dead red drum observed per trip. In addition, a release mortality (5%; consistent with SEDAR 18) was added for red drum released alive. Total gill net trips taken using estuarine gill nets in North Carolina (effort) were available through the NCTTP.

For the current assessment, discard estimates were estimated using a generalized linear model (GLM) framework to predict red drum discards in North Carolina's estuarine gill-net fishery based on data collected during 2004 through 2022 (Table 19). Available variables included mesh size, year, season and area; these were all treated as categorical variables in the model. Live and dead discards were modeled separately.

All available covariates were included in the initial model and assessed for significance using the appropriate statistical test. Non-significant covariates were removed using backwards selection to find the best-fitting predictive model. The offset term was included in the model to account for differences in fishing effort among observations (Crawley 2007; Zuur et al. 2009; Zuur et al. 2012). Using effort as an offset term in the model assumes that the number of red drum discards is proportional to fishing effort (A. Zuur, Highland Statistics Ltd., pers. comm.).

The best-fitting model was a negative binomial GLM that included mesh size, year, season and area as significant covariates for modeling both the live (dispersion = 3.2) and dead discards (dispersion = 1.9) in numbers (Figure 22). After estimates from 2004-2022 were calculated with the GLM framework, a hindcast approach using an average annual dead discard or live discard to gill net landings ratio calculated from 2004 through 2019 and 2021 through 2022 was applied to gill net landings from 1981-2003 to estimate discards consistent with the prior assessment. Estimates were not available in 2020 due to interruptions in sampling caused by the COVID-19 pandemic.

#### **4.1.1.3 Biological Sampling**

##### Virginia

Commercial length frequency data were obtained by the VMRC Biological Sampling Program (BSP). Red drum lengths and weights were collected at local fish houses by gear, area fished, and individual watermen.

Fish were measured for both TL and FL (mm) and individual weight (nearest 0.01 lb.). Typically in this program, otoliths, as well as sex and maturity data, are collected from a subsample of fish encountered. However, due to the infrequency of red drum encounters, sampling is more opportunistic and all fish encountered by technicians are sampled. Similarly, a subsample of collected age samples would be selected for full ageing, but all red drum otoliths are processed due to their typically small sample size.

Major commercial gears for Virginia are pound nets, anchored gill nets, and haul seines. Commercial samples were taken throughout the year and from all areas where red drum were landed. Fishery-dependent length frequency data collection for red drum in Virginia began in 1989. Red drum sampling events have remained infrequent throughout the program, but sampling does occur in a representative manner annually. Virginia has collected 2,818 length and 873 age samples since 1989, averaging 81 lengths and 25 ages on a yearly basis.

These data have been collected for a long time series but are limited in sample size in some years. Length data from this program were compared to North Carolina data and showed similar ranges in harvested fish due to the slot limits, with some slight differences in relative peaks within the slot sizes. These differences are likely driven by gear differences. However, the differences were not large enough to cause concern among the SAS. Due to the similarities, the complications of not having a complete time series of robust length sampling, and the small proportion of total removals accounted for by VA commercial landings, the SAS decided not to

use these length data and, instead, use the North Carolina data alone to characterize commercial size compositions for the northern stock. Age data were used for conditional age-at-length data in the SS model.

### North Carolina

Commercial length frequency data were obtained by the NCDMF commercial fisheries-dependent sampling program. Red drum lengths were collected at local fish houses by gear, market grade (not typical for red drum), and area fished.

Individual fish were measured (mm, FL) and total weight (0.1 kg) of all fish measured in aggregate was obtained. Subsequent to sampling a portion of the catch, the total weight of the catch by species and market grade was obtained for each trip, either by using the trip ticket weights or direct measurement. Length frequencies obtained from a sample were then expanded to the total catch using the total weights from the trip ticket. All expanded catches were then combined to describe a given commercial gear for a specified time period. Major commercial gears for North Carolina are gill net, long haul seine, and pound net. Commercial samples were taken throughout the year and from all areas where red drum were landed. Fishery-dependent length frequency data collection for red drum in North Carolina began in the early 1980s. Data adequate to describe the major fisheries is available beginning in 1989.

Since the late 1980s North Carolina has been the major commercial harvester of red drum, typically accounting for >90% of the coastwide annual commercial landings. Since 1989, greater than 100 lengths have been obtained annually with the majority coming from the primary gear used to harvest red drum, gill nets, followed by pound nets and haul seines (Table 20).

Lengths of discarded fish have also been recorded by observers during the observer program (Table 19). Number of lengths collected annually have ranged from 8 (2021 fishing year) to 1,838 (2012 fishing year).

#### **4.1.1.4 Catch Composition**

Length distributions for North Carolina commercial landings were derived from length data provided from commercial fish house sampling. All length distributions were described annually in two-centimeter length bins with the length bin provided representing the floor (i.e., 46 cm = 46.0 to 47.99 cm). A minimum of 20 lengths by year and gear were required to represent the length distribution of a gear. Collapsing, when necessary, occurred across gears within a year. Prior to 1989, sample sizes were sparse and were not considered adequate to describe the fishery. For this reason, the previous red drum assessment began with 1989 as the beginning year for all catch-at-age data. Since 1989, sampling was adequate for the vast majority of the landings (i.e., gill net landings in North Carolina) and pooling was limited to minor gears/landings (Table 20).

Conversion of North Carolina commercial landings in weight to numbers was based on mean weights obtained from the commercial fish house sampling. In the rare instance when sample

sizes were inadequate ( $n < 20$ ) by gear and year, a weighted average was obtained by pooling across gears within a year. For hook and line gears, mean weights from the recreational fishery (see Section 4.2.1) were used as a proxy. Landings in numbers are reported in Table 21.

#### **4.1.1.5 Catch Rates**

No useful trend information can be derived from commercial catch rate data. Trip level commercial data were available from North Carolina (1994 to 2022) and Virginia (1993 to 2022), however, catch effort data from the red drum commercial fishery were confounded by trip limits put into place in 1992 for Virginia and in 1998 for North Carolina. Trip level information was also available in Florida but only for the years 1986 to 1988. After 1988, the sale of native caught red drum in Florida became prohibited.

#### **4.1.2 Trends**

##### **4.1.2.1 Commercial Landings**

Commercial landings data are presented below in calendar year as monthly data were not available earlier in the time series, precluding presentation of historical commercial landings in the fishing year definition adopted in this assessment. Additional presentation of commercial landings in the fishing year definition during years when monthly data were available and covering the time series used in the assessment models is provided in Section 4.4.

##### Northern Stock

Northern stock red drum landings by the North\_Commercial\_GNBS fleet were primarily landed with beach seines in the 1950s and early 1960s (Figure 23). Total landings were high in the early 1950s, averaging 206,220 pounds from 1950-1954, then declined to the lowest levels of the time series in the late 1960s (minimum of 1,400 pounds in 1969). Landings then increase and transition to coming from mostly gill nets in the 1980s. Landings from the North\_Commercial\_GNBS fleet have varied without discernible trend since the 1980s, averaging 138,337 pounds from 1980-2022.

Northern stock red drum landings by the North\_Commercial\_Other fleet decline from the earliest years to low levels in the late 1960s (Figure 24). Landings then increased to higher levels in the 1970s and 1980s, averaging 77,932 pounds. Landings decline through the 1990s and remain at lower levels during recent years, averaging 17,064 pounds since 2000. Pound nets have accounted for a large proportion of the total landings throughout the time series, while trawls accounted for large proportions in the early 1950s and 1980s. Seines also accounted for a large proportion of landings from the 1960s through 1990s.

Estimated landings from RCGL gill nets in North Carolina ranged from a high of 24,750 pounds in 1999 to a low of 2,992 pounds in 1997 (Table 22). 2007 was the second highest estimate in the time series.

Overall, northern stock red drum landings were consistently high in the early 1950s, averaging 153,520 pounds from 1950-1954, then decreased through the 1960s to time series lows (minimum of 5,000 pounds in 1969, Figure 25). Landings increased through the 1970s and 1980s and have shown high interannual variability since, ranging from 58,951 pounds in 1997 to 408,021 pounds in 2013. The North\_Commercial\_GNBS fleet accounted for most of the commercial red drum landings in the northern stock in the beginning of the time series through the mid-1960s. The North\_Commercial\_Other fleet became a primary contributor to landings in the mid-1960s through the 1970s when seines accounted for a large proportion of this fleet's landings. Landings by the North\_Commercial\_Other fleet then decline and commercial landings have come primarily from the North\_Commercial\_GNBS fleet since the 1990s. The RCGL landings have accounted for ≈5% of landings (9,556 pounds), on average, since these data have been available (1989).

### Southern Stock

Southern stock red drum commercial landings were highest during the 1950s when all southern states made significant contributions to the landings, averaging 204,986 pounds from 1950-1956 (Figure 26). Landings then declined to low, stable levels and came mostly from Florida as South Carolina and Georgia made only minor contributions. Landings averaged 136,333 pounds from 1957-1984. During the mid-1980s, commercial fisheries faced tightening restrictions resulting in declining landings prior to being prohibited in South Carolina in 1987 and a moratorium in Florida in 1988. Commercial landings from the southern stock were, for the most part, phased out by 1989 when the Florida fishery was closed permanently.

Commercial landings from Florida in the 1980s were converted from pounds to number of fish during SEDAR 18 (Murphy 2009) and are presented in Table 23. Landings in numbers are highest in 1981 at just over eighty-seven thousand fish and decline throughout the 1980s until the fishery was closed permanently in 1989.

#### **4.1.2.2 Commercial Discards**

##### Northern Stock

Total commercial discards from North Carolina gill net fisheries have varied without any discernable trend throughout the time series (Figure 22). Total dead discards averaged 12,419 fish from 1981-2022 and ranged from 1,887 fish in 2010 to 38,948 fish in 2012 (Table 19).

#### **4.1.2.3 Catch Composition**

##### Northern Stock

Length distributions for North Carolina are presented by major gears in Table 24. For the length distributions, all gears showed a notable shift towards larger fish, particularly after 1991 when North Carolina implemented a minimum size limit change from 14 to 18 inches TL (Figure 27). Likewise, the harvest of larger red drum has declined as commercial sale of red drum >27 inches TL became illegal in 1992.



The majority of discarded lengths observed in the estuarine gill net fishery were from fish below the minimum size limit of 18 inches TL (approximately 44 cm FL) with some discards occurring within the slot likely due to exceeding the daily trip limit and fewer over the slot limit (Figure 29). Due to COVID-19 interruptions, lengths were not gathered in 2020 and collections were truncated in 2021.

#### **4.1.3 Potential Biases, Uncertainty, and Measures of Precision**

Collection of commercial landings data has been designed as a census to capture total landings, but methods to collect these data have changed through time leading to changes in uncertainty. There are no quantitative measures of uncertainty accompanying commercial landings data, but Table 18 shows changes to landings data collection methodology by state through time. Each methodology is anticipated to be an improvement to the data collection methodology that preceded it. Commercial landings data uncertainty was an issue addressed during a Best Practices Workshop convened by SEDAR (SEDAR 2015b). The recommendation produced from this workshop was to assume uncertainty decreases as the data collection methodology changes through time, resulting in time blocks of decreasing uncertainty levels from historic to current data collection methods.

## **4.2 Recreational**

### **4.2.1 Marine Recreational Information Program**

#### **4.2.1.1 Introduction and Methodology**

The primary source of red drum recreational catch data along the Atlantic coast is the Marine Recreational Information Program (MRIP). MRIP consists of three general surveys to estimate recreational catch, the Access Point Angler Intercept Survey (APAIS), the Fishing Effort Survey (FES), and the For-Hire Survey (FHS). The APAIS is a dockside survey where interviewers intercept anglers returning from fishing trips to collect information on catch and fishing area. Data are used to estimate species-specific catch rates by disposition, characterize the size structure and weight of fish harvested, and determine the proportion of fishing effort occurring in three general areas of marine waters (inland, state seas from the coastline out to three miles, and the federal EEZ beyond three miles from the coastline). Dispositions reported by anglers include harvested and either available for inspection (Type A catch) or unavailable for inspection (e.g., fileted at sea, Type B1 catch) and released alive (Type B2 catch). The FES is a mail-based survey that collects data on fishing effort by anglers from U.S. households fishing from shore and private/rental boats to estimate total fishing effort. The FHS is the counterpart to the FES that collects data on fishing effort by for-hire charter boat and headboat captains through a telephone survey. Each of these components of the MRIP survey have undergone design changes since 1981, with a brief description of survey design changes below. Interested readers who would like more details on the survey design changes are encouraged to review the resources available through the NMFS Office of Fisheries Statistics ([www.fisheries.noaa.gov/recreational-fishing-data/about-marine-recreational-information-program](http://www.fisheries.noaa.gov/recreational-fishing-data/about-marine-recreational-information-program)).

MRIP surveys implement a stratified sampling design, stratifying by state, year, wave (bimonthly period), and fishing mode (shore, private/rental boat, headboat, and charterboat). Catch rate data collected during the APAIS for each stratum are applied to total effort data from the FES and FHS to estimate total harvested catch (Type A+B1 catch) and total catch released alive (Type B2 catch). The area data collected during the APAIS are used for post-stratification of estimates by area.

Biological data collected during the APIAS sampling include FL and weight of Type A fish. Both are collected opportunistically but field interviewers are instructed to measure and weigh up to fifteen fish of each available species from each angler interviewed. The individual fish are to be selected from the total landed catch at random to avoid any size-bias in the resultant sample. These data are used to estimate harvest in weight and the size composition of harvested fish.

Two significant changes have occurred to the MRIP survey methodologies based on external reviews and recommendations throughout the duration of the program. The APAIS was redesigned in 2013 to improve the sampling design and the use of APIAS data in catch estimation methods. In 2018, the telephone-based effort survey used historically to collect effort data from U.S. households (Coastal Household Telephone Survey-CHTS) was replaced with the current mail-based FES. Since the last red drum stock assessment occurred before the effort survey change, historical estimates prior to 2013 used in that assessment were calibrated to correct for the APAIS redesign in 2013, but all estimates used in the previous assessment were based on CHTS effort data. MRIP now provides all historical estimates prior to 2018 with calibrations applied to correct for both the APIAS redesign changes and the transition to the mail-based FES and these calibrated data were first reported in the simulation assessment (ASMFC 2022). The FES results in increases in effort estimates and, therefore, total catch estimates relative to the CHTS.

Ongoing MRIP evaluations recently indicated potential overestimation of private/rental and shore fishing effort through a small-scale pilot study. These studies are currently being expanded, but effects to total private/rental and shore effort estimates, and therefore catch estimates, were not available in time for this assessment. See the MRIP website for more details on this development (<https://www.fisheries.noaa.gov/recreational-fishing-data/fishing-effort-survey-research-and-improvements>). Potential impacts from this development were investigated through sensitivity analysis in consultation with MRIP staff (Section 6.2.2).

#### **4.2.1.2 Trends**

##### **4.2.1.2.1 Total Catch**

Investigated herein were harvest, numbers released, dead discards, and total removals (harvest + dead discards) annually by fishing year. Data for the 2022 fishing year are preliminary. Dead discards, and subsequently total removals, were calculated based on an 8% discard mortality rate for recreationally captured and released red drum, consistent with SEDAR 18 and SEDAR 44.

## **Total Harvest**

### Northern Stock

Harvest from the northern stock was relatively high in the 1980s, decreased significantly in 1990, and remained at these lower levels through the mid-2000s (Table 25, Figure 30). Harvest then increased to higher levels through the remainder of the time series, including the three highest annual harvests during the time series (2013, 2016, and 2020). Interannual harvest is highly variable reflecting year class strength in this recruitment-based fishery.

Proportional standard error (PSE) for harvest estimates is higher in the 1980s, exceeding 40% in three years (Table 25, Figure 31). PSEs then decline and remain below 40%. Estimates with PSEs below 40% are considered valid inputs for stock assessment models, while estimates with values between 40% and 60% should be used with caution, and any estimates with PSEs >60% should be used with extreme caution (ACCSP 2016). Harvest estimates with confidence intervals are provided in Figure 32.

### Southern Stock

Patterns of harvest from states in the southern stock have been similar to the northern stock, with higher harvest early in the time series, lower harvest in the middle of the time series, and higher harvest in recent years (Table 26, Figure 33). Florida has accounted for the most harvest, followed by South Carolina and Georgia.

PSEs in southern stock states are generally higher in the 1980s and 1990s, then decline to lower levels since (Table 26, Figure 34). PSEs exceed 40% in several early years in South Carolina and Florida and exceed 60% in 1983 and 1981 in South Carolina and Georgia, respectively. Notably, there was an increase in PSE for Florida at the end of the time series, though values remained below 40%. Harvest estimates with confidence intervals are provided in Figure 35.

## **Total Discards**

### Northern Stock

Red drum released alive in the northern stock accounted for a smaller proportion of total catch in the 1980s, but then increased through the remainder of the time series and account for an increasing majority of total catch (Table 25, Figure 30). Assuming an 8% discard mortality due to catch, consistent with past stock assessments, dead discards account for a similar, though generally slightly lower, proportion of catch as the harvest since the early 2000s.

PSEs for discarded catch are high in the 1980s and regularly exceed 60% (Table 25, Figure 31). PSEs then decline to levels lower than 40% in the mid-1990s and become similar to PSEs for harvested catch through the remainder of the time series. Discard estimates with confidence intervals are provided in Figure 32.

### Southern Stock

Red drum released alive in the southern stock have also increased through the time series and become bigger components of the catch, though these changes have occurred differently in each of the states (Figure 30, Figure 33). Releases have regularly exceeded harvest since the mid-1980s in Florida, since the mid-1990s in South Carolina, and since the early 2000s in Georgia. As with harvested fish, Florida has accounted for the most followed by South Carolina and then Georgia. With the assumed 8% discard mortality, dead discards have yet to exceed harvested catch in any of the southern states as seen occasionally in the northern stock. However, annual dead discards still account for a significant proportion of annual total removals, averaging 37%, 18%, and 35% in South Carolina, Georgia, and Florida, respectively, during the last five years of the time series (2018-2022).

PSEs were high in South Carolina through the mid-1990s, exceeding 40% and 60% in several years (Figure 30, Figure 34). PSEs then decrease markedly and are typically lower than harvest PSEs since the mid-2000s. PSEs in Georgia were above 40% through 1984 with two years above 60%, decline to lower levels through the 1990s with only one year above 40% (1989), and decline further to values similar those for harvest estimates in years since the 1990s. PSEs for Florida discards are also high in the 1980s and early 1990s with several exceeding 40% and one exceeding 60%, then decline to low levels similar to harvest PSEs. Discard estimates with confidence intervals are provided in Figure 35.

## **Total Removals**

### Northern Stock

When harvest and dead discards are combined, removals from the northern stock initially decreased from highs in the mid- to late-1980s and remained low and stable through the mid-1990s (Figure 36). From these lows, total removals have steadily increased to all-time highs in recent years. There tend to be cyclical patterns with high removals occurring in two- to three-year periods.

Assuming PSEs for dead discard estimates are equal to PSEs for released alive estimates, PSEs for removals were higher in the 1980s, exceeding 40% in several years, decreased to levels around 20% in the early to mid-1990s, and decreased further in the late 1990s (Figure 37). There was an increase in the late 2010s, but PSEs have been below 40% every year since 1989.

### Southern Stock

When harvest and dead discards are combined, removals from the southern stock initially decreased in each state from highs in the early- to mid-1980s (Figure 38). Trends then differ by state. In South Carolina, total removals continue to decline through the 1990s, then increase through the 2000s and become stable at higher levels in the 2010s. Total removals generally increased since the 1980s in both Georgia and Florida, but at a greater rate in Florida. Removals in the late 2010s were at levels similar to the 1980s in all states. Removals are variable across states in the 2020s but were at lower levels than the 2010s in South Carolina and Florida.

PSEs in all states have decreased through time and have only exceeded 40% in a few years, primarily during the 1980s (Figure 39).

### **Imputed Wave 1 Catch Estimates**

MRIP has only consistently sampled anglers and generated catch estimates for wave 1 (January-February) in Florida waters. Some estimates were generated for Georgia in the 1980s, and estimates have been generated for North Carolina since 2006. No estimates have been generated for South Carolina, though the SCDNR State Finfish Survey (SFS) has sampled wave 1 catch with similar or identical protocols to MRIP (see Section 4.2.2). These estimates and supplementary data indicate there have been catches in wave 1 in these South Atlantic states, albeit generally lower catches relative to other waves throughout the year. To address this potential bias, catch estimates were imputed for states and years with no wave 1 catch estimates using disposition-specific (harvested vs. released alive) ratios of wave 1 to wave 2-6 catches in years when wave 1 catch information was available.

For North Carolina and Georgia, the medians of annual ratios of wave 1 to wave 2-6 MRIP catch estimates (Figure 40 and Figure 41) were applied to annual wave 2-6 MRIP catch estimates in years with no wave 1 catch estimates to impute catch estimates (Figure 42 and Figure 43). All available wave 1 catch information for Georgia was from the 1980s when fishing practices were different and highly skewed to harvesting. The median released alive ratio was 0 due to these low released alive catch estimates. Therefore, the median harvest ratio (0.04) was used for imputed released alive estimates to better capture fishing practices of more recent times. For South Carolina, the medians of annual ratios of wave 1 to wave 2-6 catch frequencies from the SCDNR SFS (Figure 44) were applied to annual wave 2-6 MRIP catch estimates in all years to impute catch estimates (Figure 45).

Magnitudes of imputed wave 1 catches are very small relative to overall annual catch and were generated with different methods than catch estimates provided by MRIP, so the SAS decided to use catch streams provided from MRIP without these imputed estimates as base data sets in assessment models. Imputed catch impacts were explored through sensitivity analysis.

#### **4.2.1.2.2 Catch Composition**

##### **Harvest**

##### **Northern Stock**

Annual length compositions for fish harvested from the northern stock are in Figure 46. When aggregated within regulation periods (Figure 47), length compositions show a shift to larger sizes in later years (>1991) as well as decreasing catches of larger fish protected by the slot limit.

The number of MRIP primary sampling units (PSUs), which is a unique interviewer assignment for sampling catch, with red drum encountered for length measurements are presented here along with the raw number of red drum measured for length. However, clustered sampling results in sample sizes less than the absolute number of individuals measured for size due to aggregations of like-sized individuals (Nelson 2014). Therefore, PSUs are used in the assessment as a proxy for length composition sampling replicates (i.e., precision), assuming a clustered sampling design (i.e., lack of independence).

The number of PSUs encountering red drum in the northern stock increased through the mid-1990s and has since varied without trend (Figure 48).

### Southern Stock

Annual length compositions for fish harvested from the southern stock states are in Figure 49, Figure 50, and Figure 51 for South Carolina, Georgia, and Florida, respectively. When aggregated within regulation periods (Figure 52-Figure 54), length compositions show regulatory-induced shifts such as narrowing slot limits.

PSUs in South Carolina and Georgia varied without much trend (Figure 55). PSUs in Florida increased to the highest levels in the 2000s and declined to lower levels in recent years.

### **Discards**

A primary data limitation in past red drum stock assessments has been the lack of data to describe the length and age composition of fish released alive in recreational fisheries. Because a portion of these fish are assumed to die due to interaction with the fishery (i.e., fishing mortality) and this component of the catch has become an increasingly large proportion of the total recreational catch, the lack of these data introduces a growing uncertainty in stock assessments. A number of supplementary data sources have been considered as proxy data sources including the state tagging programs (Section 4.3) and phone applications designed to collect voluntary data from anglers (iAngler- <http://angleractionfoundation.com/iangler> and MyFishCount - <https://www.myfishcount.com/>). These data sets were revisited during this assessment for consideration as proxy data sources.

The available phone application data sources provide limited data due to starting up more recently and growing their user bases, so efforts focused on tagging programs. Two data sets from these tagging programs were evaluated including sizes of fish tagged by volunteer anglers and sizes of tagged fish recaptured by anglers and subsequently released.

In the northern stock where all states' recreational fisheries have been combined into a single fleet in past stock assessments, there are tagging programs in Virginia and North Carolina. Historical North Carolina data (prior to 2014) were undergoing QA/QC procedures to align them with standards in place since 2014 and were not available for the assessment. Virginia data from the Virginia Game Fish Tagging Program (VGFTP) were available back to 2000. The North Carolina program employs both agency personnel and anglers to tag fish. Agency personnel tag all sizes caught during monitoring, but anglers have been instructed to only tag fish >27 inches since 2014 introducing a bias in the data set of sizes tagged by anglers. The VGFTP has not instructed anglers to tag particular sizes in any years highlighting the bias in the North Carolina data set and demonstrating better representation of sizes caught and released by anglers (Figure 56). Size compositions of tagged fish compared to MRIP harvest size compositions show the transition from releases to harvest in the management slot.

The data sets of tagged fish recaptured by anglers show smaller sizes recaptured and released by North Carolina anglers addressing the bias in the data set with fish tagged by anglers, but are limited in sample size and often noisy data sets. The noise can be seen in the comparison of

VGFTP data sets (Figure 57; e.g., early 2000s, 2015, 2017-2018) as well, but there are consistencies between data sets in years with better sample sizes of recaptured fish (e.g., late 2000s and early 2010s). The sizes of fish tagged by anglers show consistent modes prior to minimum legal size and for large bull red drum which is intuitive given the regulations in place (Figure 58). This also indicates volunteer anglers are still harvesting fish of legal size and their decision-making process while tagging is not biased towards practices of tagging and releasing all sizes caught including legal-sized fish. Based on these evaluations, the VGFTP data set of sizes of fish tagged by volunteer anglers represents the best proxy data set to use for fish released alive in the northern stock. Potential bias remaining in this data set includes providing size compositions not representative of the overall northern stock given these data don't come from the state that accounts for the majority of catch (North Carolina).

In the southern stock, there are tagging programs in South Carolina (Marine Game Fish Tagging Program, MGFTP, and fishery-independent tagging programs) and Georgia (Cooperative Angler Tagging Project, CATP). South Carolina employs agency personnel and volunteer anglers to tag fish and has large data sets but has provided varied instructions through time on sizes that should be tagged to anglers participating in the MGFTP. Anglers were instructed to only tag fish  $\geq 18$  inches from 1993-2010 and fish  $>10$  inches since 2020. Agency staff tagging covers more of the population size structure, but they have been instructed not to tag fish  $<250$  mm (9.8 inches) from 1992-1998 and 2002,  $<300$  mm (11.8 inches) from 1999-2001, and  $<350$  mm (13.8 inches) from 2003-2022, increasingly limiting representation of the smallest sizes. Early tagging data show capture of smaller sizes (both for tagging and in recaptures) before instructions to anglers participating in the MGFTP to limit tagging to sizes  $\geq 18$  inches in 1993 (Figure 59). These sizes are then phased out of the distributions indicating bias from tagging program instructions. Once these instructions were rescinded in 2011, the smaller sizes in the distribution below the slot limit phase back in (Figure 60). Anglers were instructed to tag fish  $\geq 10$  inches in 2020, but proportions for these sizes are negligible in earlier years and there is no clear impact to the size distributions from these instructions. Sizes of angler recaptures and subsequent releases show a slight bias in the smaller sizes as these fish are growing rapidly at these sizes and aren't showing up in recaptures until they've grown beyond the sizes first tagged, as well as potential bias from instructions to agency personnel in more recent years not to tag the smallest sizes.

Based on these evaluations the data set of sizes tagged by anglers from 1989-1992 and 2011-2021 represents the best proxy data set to use for fish released alive in South Carolina (Figure 61). However, a potential bias remaining in this data set is the paucity of larger, bull red drum despite a known catch and release fishery for these sized fish in South Carolina waters. This is due to anglers participating in the tagging program being biased towards those fishing inshore and not targeting bull red drum. This potential bias was discussed throughout the assessment and ultimately was considered too significant to use these data as a proxy data source in the stock assessment models. Representative size distribution data for fish released alive in South Carolina remains a major data limitation for the assessment.

The Georgia tagging program also relies on agency personnel and volunteer anglers to tag red drum. The program instructed anglers to only tag red drum  $\geq 16$  inches prior to 2011. The

impact of these instructions can be seen in both the limited tagging and recapture data sets (Figure 62). Beginning in 2019, program administrators encouraged tagging of sub-legal sized fish as well as all other sizes. The impact of these instructions is reflected in size distributions when sub-legal sized fish not seen in previous years show up in the distributions. A similar slight bias in recaptures subsequently released as seen in South Carolina data shows up in recent years of Georgia data due to rapid growth of the smallest sizes (e.g., 2020). Based on these evaluations, the data set of sizes tagged by anglers from 2018-2021 represents the best proxy data set to use for fish released alive in Georgia (Figure 63).

No tagging data are available from Florida and Florida state specific red drum assessments have used the phone application-based iAngler data as proxy release size compositions, so these data were used for this purpose in this assessment as well. The data are limited but do represent sub-legal sized fish and infrequent captures of fish larger than the maximum legal size (Figure 64).

In general, the tagging data from volunteer anglers were the best proxy data sets for states that had tagging programs. These data are not affected by time-varying effort like recaptures of fish subsequently released that were likely tagged across multiple years, some of which may have occurred under varying tagging instructions from the tagging program. These data sets typically have the largest samples sizes as well. It is assumed that volunteer anglers participating in tagging are representative of the general angling population and provide a representative sample of sizes available to anglers that get released (i.e., choice to tag is akin to choice of other anglers to release and not harvest), with the exception noted for South Carolina data.

#### **4.2.2 Supplemental Recreational Sampling**

There are several recreational fishery monitoring efforts by state agencies conducted aside from the general MRIP survey. The primary use of these efforts in past stock assessments has been to provide supplemental age-length key data for generating age composition data, as they were during this assessment.

##### **Virginia**

Since 2007, the VMRC has operated a recreational carcass recovery program known as the Marine Sportfish Collection Project. The goal has been to supplement the Biological Sampling Program with species that are traditionally scarce in the commercial sector and to characterize VA's recreational fishing activity. Chest freezers are established near fish cleaning stations at a rotating series of marinas and boat ramps in the Chesapeake Bay region, depending on seasonality and freezer availability. Each freezer is marked with an identifying sign and a list of target fish species. Cooperating anglers place the filleted carcasses, with head and tail intact, in a bag, drop in a completed donation form, and then place the bag in the freezer. Each fish is identified to species, the fish length is measured, sex is determined when possible, and the otoliths are removed. These otoliths are incorporated into the subsampling scheme of VMRC's ageing lab, with their original recreational status recorded for later reference.



The number of red drum collected by the Marine Sportfish Collection Project has traditionally been low, with notable peaks in 2009 (n=73) and 2013 (n=79) with 530 samples recovered since 2007. These fish ranged in size from 405-1146 mm TL with an average of 558 mm TL.

### **North Carolina**

In 2014, the NCDMF initiated a formal Carcass Collection Program. The objective of the project is to develop a statewide freezer collection program to obtain fishery-dependent length, sex and age samples of recreationally important fish. Since the beginning of the program, the NCDMF has maintained eight operational freezer sites where carcass collection occurs. Sites include tackle stores, fishing piers, shore access points and local NCDMF offices. NCDMF staff make scheduled checks of freezers to collect carcasses and resupply freezers with collection bags and information cards. Fish samples collected from the freezers are processed and entered into the NCDMF biological database. Information collected includes species of fish, length of fish, sex, otoliths for aging and catch information (fishing mode, date, location etc.). Samples of red drum collected annually have ranged from 20 (2015 Fishing Year) to 149 (2022 Fishing Year) with 708 collected from 2015 to 2022. Most red drum collected in the carcass collection program are age-1 and age-2 with some age-3 fish. This range of ages is consistent with the size of fish that can be legally harvested in the 18-to-27-inch slot limit.

### **South Carolina**

#### *Inshore Fisheries-Dependent Biological Sampling Programs*

Given the limited information on the size and age of recreationally harvested fish from South Carolina waters, the SCDNR Inshore Fisheries Research Section conducts two fishery-dependent biological sampling programs, namely a fishery-dependent freezer fish program and a fishery-dependent tournament sampling program. Both are designed to collect biological information on the size, age, and sex composition of recreationally harvested priority species. Red drum are included as a priority species of interest for both programs.

#### *Freezer Fish Program*

Since 1995, Inshore Fisheries has operated a freezer drop off program for recreationally important inshore finfish, enabling fish collection from areas and habitats not always represented in SCDNR monthly field sampling. Chest freezers are located near collaborating marinas, landings, or bait shops along the South Carolina coast. Participating anglers place the filleted rack with head and tail intact in one of the provided bags, drop in the completed catch information card, and deposit the bag in the freezer. Freezers are checked periodically by SCDNR staff and provided fish racks are brought back to SCDNR facilities for processing. Once in the lab, fish are identified to species, lengths are recorded, sex and maturity status are determined when possible, genetic samples are collected, and otoliths are removed. Otoliths are aged annually with each recreational capture day considered an independent collection event.

The number of red drum collected by the Inshore Freezer Fish Program is relatively low (Table 27) with the bulk of collections occurring from 1995 to 2003 (n = 1,412). Collections have

declined further in recent years with ranges from 100 in 2007 to 0 in 2021, with an average of 46 collected annually from 2004 to 2022. Historically, 2,283 have been processed by staff since the program began ranging in size from 343-810 mm TL with an average of 484 mm TL.

### Tournament Program

Inshore Fisheries began participating in Recreational Angler tournaments in 1986. Inshore staff act as weigh master at tournaments and collect biological samples from fish of participating anglers. Similar to the freezer fish program, fish are identified to species, lengths are recorded, sex and maturity status are determined through gross and histological sampling, genetic samples are collected, and otoliths are removed.

Since 1986, 1,023 red drum have been sampled at tournaments (Table 27) with a minimum size of 277 mm TL and a maximum size of 1,150 mm TL. Average size is 552 mm TL.

### State Finfish Survey

Implemented in 1988, the State Finfish Survey (SFS) was designed to address specific data gaps, within the Marine Recreational Fisheries Statistics Survey (MRFSS; precursor to MRIP), as identified by SCDNR staff. These data gaps included the lack of length data from species of concern to the SCDNR and the lack of seasonal and area-specific catch frequencies. Another concern was the lack of catch and effort data from private boat anglers, which make up a majority of the angling trips in South Carolina coastal waters. These data gaps were initially addressed by interviewing inshore anglers targeting red drum and spotted seatrout at specific sample locations. Beginning in 2002, more emphasis was placed on acquiring length data from all finfish retained by anglers, canvassing at additional sampling locations, and interviewing all private fishing boats within all South Carolina coastal areas. Broadening the scope of the survey may decrease some of the bias associated with the previous SFS protocol.

Sampling is conducted at public and selected private (with owner's permission) boat landings from January through December using a questionnaire and interview protocols similar to those implemented through the MRFSS. However, the SFS questionnaire focuses on vessel surveys rather than individual angler surveys and primarily targets private boats. Interviews are obtained from cooperative anglers at each sampling site. If an angler is unwilling to participate, they can decline to be interviewed. Assigned creel clerks interview as many anglers as time allows at any given site.

The sampling schedule is determined by "needs assessments" of the SCDNR Marine Resources Division and creel clerks. Individual creel clerks are assigned to a sampling region and will determine their daily sampling schedules based on local conditions (i.e., weather, landing closures, or events), additional job duties, and research and management initiatives. Attempts are made to assess all sampling sites equally, and individual creel clerks randomly rotate between sampling locations within their region. Creel clerks will remain at landings with fishing activity. If landings have little or no fishing activity creel clerks will move on to alternative sampling locations in close proximity.

The SFS uses a questionnaire and interview protocol similar to MRFSS/MRIP, with the same staff conducting both surveys since 2013. Data collected for the SFS questionnaire include:

1. Mode fished (i.e., private, charter, shore)
2. Specific body of water fished
3. Area fished (inshore, 0-3 miles, > 3 miles)
4. Utilization of artificial reef/reef name
5. Resident county of boat owner
6. Species targeted
7. Number of anglers participating on the vessel
8. Amount of time spent fishing for the trip
9. Expense of the trip (all anglers)
10. Angling trips the previous year, average of all anglers participating
11. Catch and disposition by species (includes both landed and released fish)
12. Length measurements obtained, with anglers' permission, for retained species; 1988 – March 2009: length measurements mid-line length (ML); April 2009 – present: length measurements (TL)

Intercept data are coded and key entered into an existing Access database. Queries are used to look for and correct anomalous data and a component of the database records are checked against the raw intercept forms.

For the period January 1988 through February 2013, data are available from each month of the year. Beginning in 2013, SFS staff took on the duty of conducting the MRIP survey in SC and as a result the traditional SFS survey only operates during the months of January and February (no MRIP sampling during this period). Given this, traditional SFS data from March-December is generally included in MRIP landings reported for South Carolina since 2013.

The SFS collects information on both the nature of individual fishing trips and biological information on the species captured during the trip from cooperating anglers. Trip level information includes the date, location (intercept site, fishing location, and locale (estuarine, nearshore, offshore), fishing mode (private, shore, charter, etc.), purpose of the trip, target (primary and secondary) species, and angler information such as the number of anglers, hours fished, and average number of trips during the previous year across anglers in the party. Recorded biological information includes the species caught and the number and dispositions of caught fish. For those fish harvested, length information is verified for creel clerks and provide an analogous data set to that obtained from the harvested fish encountered by the MRFSS/MRIP APAIS. For released fish, the creel clerks obtain information on the number of legal sized fish released and the number of illegal (i.e., outside the slot limit for red drum) fish releases as well as obtain self-reported size information from the anglers on these released fish.

From 1988 through 2022, the SFS conducted 73,657 interviews, with red drum being caught in 8,643 interviews, or approximately 12% of all trips. These red drum positive trips reported the capture of 40,100 fish (landed and released), with 11,787 (~29%) harvested and 28,313 (~71%)

released. The survey obtained length information from 11,487 fish (11,309 harvested fish; 178 released fish).

The nature of this survey suggests at least four potential uses in red drum stock assessments. Specifically, it provides the only source of fishery-dependent information related to the harvest and relative abundance of red drum in South Carolina waters during wave 1 (January and February). This leads to its second potential use, as a means to impute wave 1 catch and discard of red drum in South Carolina (Figure 65), as was done in Section 4.2.1. Third, due to the acquisition of length information, the survey provides information on recreational length compositions. A final use of this dataset could be to understand temporal changes in fisherman behavior relative to fishing practices, locations, within year timing of fishing, etc. which could become important to defining selectivity blocks. For example, the survey provides another source of information suggesting an increase in catch-and-release fishing throughout coastal South Carolina (Figure 66).

### **Georgia**

In the fall of 1997, the Georgia Department of Natural Resources (DNR) initiated the Marine Sportfish Carcass Recovery Project. This project takes advantage of the fishing efforts of hundreds of anglers by turning filleted fish carcasses that anglers would normally discard into a source of needed data on Georgia's marine sportfish. Chest freezers are placed near the fish cleaning stations at 20 locations along coastal Georgia. Each freezer is marked with an identifying sign and a list of target fish species. Cooperating anglers place the filleted carcasses, with head and tail intact, in a bag, drop in a completed angler information card, and then place the bag in the freezer. Each fish is identified to species, the fish length is measured, sex is determined when possible, and the otoliths are removed. A subsample of otoliths is aged annually. Each day is considered an independent sampling event. Red drum recovered through this program are typically within the slot limit of 14"-23" and mostly consists of individuals aged 0 to 2 years old.

The number of red drum collected by the Carcass Recovery Project ranged from 229 in 2006 to 1,336 in 2010 with an average of 628 fish collected each year. Staff have processed 16,346 red drum since the project began. These fish ranged in size from 225-950 mm FL with an average of 406 mm FL.

## **4.3 Tagging Programs**

### **Virginia Game Fish Tagging Program**

Since 1995, the VGFTP has tagged recreationally important finfish with the help of volunteer anglers. A cooperative effort between the Marine Advisory Program at the Virginia Institute of Marine Science (VIMS) and Saltwater Tournament at the VMRC, the program's funding is from state saltwater license funds and VIMS.

The number of cooperating anglers has changed from year to year and does not correlate with the number of fish that will be tagged each year. From 1995 through 2021, approximately 250 rotating anglers have tagged and released 64,871 red drum, peaking in 2012 with 18,461 tags.

In recent years the number of red drum tags deployed by the VGFTP has decreased from a period of high volumes of tags between 2005 and 2013. Tag returns have remained mostly stable throughout the lifetime of the survey, with an average return of 9% in the first year, but spikes have occurred periodically, most recently in 2014, with 11% recaptured in the first year (341 fish recaptured out of 3,028 tagged fish).

Anglers in the program have tagged primarily sub-legal fish, with the average TL being 16.9", below the 18"-26" slot limit in VA. Early in the program, larger fish were targeted to some degree, with the max recorded TL at 58".

### **North Carolina**

The NCDMF has conducted a tagging study on red drum since 1983. Tagging has been conducted using a variety of means and methods. The NCDMF has conducted directed and opportunistic tagging with trained NCDMF staff since 1983, in addition to trained anglers. During this period, anglers have tagged red drum primarily with large stainless-steel dart tags inserted in the muscle of the fish near the middle of the dorsal fin. Due to the large tag size, volunteer taggers were instructed to tag only large red drum (primarily greater than 685 mm TL) while NCDMF tagging efforts have focused on tagging sub-adult red drum (<685 mm TL) using primarily internal anchor belly tags.

The number of cooperating anglers has changed from year to year and does not correlate with the number of fish tagged each year. Over the entire period, 92 taggers have participated in the red drum tagging program. Typically, most fish are tagged by a small subset of taggers who are commonly fishing guides. Prior to 2004, less than 15 anglers participated annually tagging approximately 600 fish per year. From 2004 to 2019, an average of 22 anglers tagged 1,064 red drum per year with a high of 1,742 tagged in 2006. Participation in the volunteer tagging program has declined in recent years with 12 taggers tagging 245 red drum in 2019. This decline in numbers tagged has been driven by some attrition of traditional high-volume taggers. In 2020 and 2021, volunteer tagger participation remained low because of impacts related to the COVID-19 pandemic. During these two years, 15 taggers put in effort to tag 302 red drum. These declining numbers in both volunteer tagger participation and tagged red drum prompted the Multi-Species Tagging Program to begin recruiting new volunteers and re-engaging with former volunteers who stopped tagging for a variety of reasons. In 2022 and 2023, the tagging program added 30 new volunteer taggers and saw participation rates increase to 28 volunteers actively tagging—10 former volunteers and 18 new volunteers—who tagged 418 red drum total for the two-year period.

The angler tagging program combined with tagging from NCDMF staff has resulted in more than 80,000 red drum being tagged from 1983 to 2022. Since 1991, greater than 1,000 red drum have been tagged annually. Volunteer anglers accounted for approximately 35,000 of these tagged fish. Tagging program guidelines for volunteer anglers has changed throughout the time series with the most recent rule, 1999-present, to only tag red drum >27" TL with stainless steel dart low-reward tags. NCDMF staff have tagged red drum <27" TL with internal anchor high and low reward tags and >27" TL with stainless-steel dart low reward tags throughout the time

series. Recent volunteer tagged red drum averaged 37"TL from recreational anglers. Recent NCDMF tagged red drum averaged 18"TL with a range from 8" to 50"TL. Over the time series, the return rate across tag types and taggers has been approximately 11%. Recapture rates vary based on size of fish at tagging and the tag type used.

### **South Carolina**

The SCDNR has a long history of supporting conventional tagging programs with the primary goal of providing a forum for angler outreach and a mechanism for developing a conscientious angling public who know and utilize best fishing practices. In addition, the conventional tagging program is a platform used for the collection of valuable information on fish populations, including information on movement and migration, gear selectivity, and exploitation rates. To this end, SCDNR employs two complimentary tagging programs, the South Carolina Marine Game Fish Tagging Program (MGFTP) and the Inshore Fisheries Fishery-Independent tagging program.

#### *Marine Game Fish Tagging Program*

The MGFTP began in 1975 and was the first state-sponsored public tagging program on the East Coast. The program was initiated with a small contribution from the Charleston-based South Carolina Saltwater Sportfishing Association. Today, the program receives funding from the U.S. Fish and Wildlife Service's Sport Fish Restoration Act and South Carolina Saltwater Recreational Fishing License Funds. The tagging program has proven to be a useful tool for promoting the conservation of marine game fish and increasing public resource awareness with >19,000 participants having participated in the program including over 150 active taggers in 2022. In addition, the program has provided biologists with valuable data on movement and migration rates between stocks, growth rates, habitat utilization, and mortality associated with both fishing and natural events. The first red drum tagged via this program was released in 1978.

The MGFTP covers the entire coast of South Carolina. Most of the tag and recapture events occur inshore, leading to a bias towards tagging sub-adult red drum available in estuarine waters, but the program does collect data from nearshore and offshore sites. Data collected by the program includes tag number, date, species, length, length type, location, condition of fish upon release, and disposition of catch (in the case of a recapture).

The survey has directed its cooperative recreational anglers who are tagging red drum to target different size classes of red drum through time (Table 28). Currently anglers are requested to only tag red drum greater than 10 inches (254 mm) TL and that they only tag one red drum per "school" per day when fishing inshore waters. Further, they are requested to tag different sized red drum with different types of tags, using a T-bar tag for any fish less than 27 inches TL and a nylon dart tag for fish 27 inches TL or greater.

Since its inception, the MGFTP has deployed 96,626 red drum tags and 14,807 recaptures have been reported. Of these recaptures, 73% were reported as being re-released. Peak red drum tag deployment occurred in 2017, 2018, and 2019 (4,596, 6,863 and 6,446 respectively). In more recent years, limitations were put on how many red drum a single volunteer could tag per

day. This effort was put in place to allow for a greater number of program participants. During 2020 and 2021, combined anglers deployed 4,985 tags.

### *Inshore Tagging Program*

Since 1986, the Inshore Fisheries Research section of the SCDNR Marine Resources Research Institute (MRRRI) have tagged red drum captured during research and survey sampling. As such, we have tagged most released red drum captured by our sub-adult (stop net, trammel net, and electrofishing surveys; 1986-present) and adult (historic and contemporary longline surveys; 1994-present) fishery-independent surveys. In addition, red drum have been tagged through a number of specific research projects (tag reporting rate studies; tagging of red drum outside of SC, etc.). For this program, fish are measured and tagged with either an internal anchor “belly” or stainless steel anchor “shoulder” dart tag, based on size, before being released at their site of capture (Figure 67). Released fish larger than 550 mm TL are tagged using the shoulder tag, with all released red drum between 350 and 550 mm TL tagged using the belly tag. Data collected at tagging include collection level information retained as part of the survey (e.g., water quality, location (site, stratum, latitude/longitude), date, etc.), fish length (nearest mm SL and TL), and disposition (released with tag). As all released red drum not previously recaptured greater than 350 mm TL are tagged, this program exhibits a spatial footprint as large as the widest footprint of our fishery-independent surveys, resulting in the tagging of red drum across all five South Carolina estuaries and in both estuarine and coastal waters.

Regardless of source, the desired information on angler recaptures of tagged fish remains the same. Anglers are asked to report their contact information (full name, mailing address, and telephone number), the species of fish caught, the tag number, the date and location of the recapture, and the length and disposition of the fish (was the fish retained or released, and if released, was the tag removed or left on the fish). Each angler is offered a reward of either a t-shirt, printed to commemorate their catch, or a cap, with an embroidered logo. For each recapture, a report is mailed to the angler with information on the fish that they caught, including when and where it was originally tagged and its length at that time, how long the fish was at large, a minimum distance it traveled, and any other recaptures that have been reported for the fish, including project recaptures that may have occurred during inshore fishery-independent sampling. A cover letter is sent to each angler, with recent statistics on the numbers of fish tagged by the program and contact information for questions or reporting future recaptures.

Since its inception, the Inshore Tagging Program has tagged 75,413 red drum and obtained 31,699 red drum recaptures.

### *Combined SCDNR Tagging Program Data*

Since 1978, across programs the SCDNR conventional tagging programs has tagged 172,087 red drum through 2022 (Figure 68), with 46,506 recaptures (Figure 69). Based on disposition, the conventional tagging data suggests catch-and-release rates of red drum in South Carolina has

increased through time, with series lows in the late-1980s when the release rate was less than 25% to release rates in excess of 75% every year since 2000 (Figure 70).

Days at large of recaptures has varied greatly, from as short as the same day to as long as 8,403 days-at-liberty (Figure 71), with 11,576 recaptures of red drum at large at least 1 year since tagging (Table 29). The longest-at-liberty was a fish originally tagged via the SCDNR trammel net survey on 11/9/1992 when it was 580 mm TL. This individual was recaptured by an angler on 11/12/2015 in the Cooper River with a length of 1067 mm TL.

Based on location information, we can also infer information about minimum straight-line distance moved based on time-at-large for red drum based on this conventional tagging program (Figure 5). While the maximum minimum straight line distance moved was 467 km observed for a fish at-large for 739 days, only 28 fish moved >250 km with these 28 fish having days-at-large of 33-739 days. Only 0.6% of all recaptures (n = 272) occurred out of the state of South Carolina.

As part of the SCDNR tagging program, data is collected on the lengths of red drum encountered by recreational anglers across the state of South Carolina. This includes both the length at initial tagging (MGFTP only) and length at recapture by recreational anglers (MGFTP and FI tagging program). Coupled with disposition information (harvest vs. released), this provides a robust data set for investigation of harvest and release length compositions across coastal South Carolina. However, there are several caveats regarding the use of these data, including the self-reported nature of recreational length data and the biased distribution of lengths of tagged fish in the population.

## **Georgia**

Georgia's Cooperative Angler Tagging Project (CATP) began in 1987 and was created to involve anglers in tagging adult red drum as part of in-house research on the species. Tagging has proven to be a useful tool for promoting fish conservation as well as collecting valuable data on movement and migration, growth rates, habitat preference, and post-release survival. Partnering with recreational anglers is an efficient and cost-effective way for researchers to collect fisheries data and often creates a sense of ownership towards fisheries management decisions.

The number of cooperating anglers has changed from year to year and does not correlate with the number of fish that will be tagged each year. The number and species of fish tagged has varied over time as research objectives and staff have changed. From 1987 through 2022, approximately 250 cooperating anglers tagged and released over 6,000 red drum. In recent years the number of red drum tags deployed by the CATP has increased. Since 2017, 6,408 tags have been released, between 850-1,323 annually. Tag returns have also increased, with 1,243 total recaptured during the period.

Historically, cooperative tagging anglers tended to tag larger red drum, with a bimodal distribution of fish at the upper end and above the slot. The addition of staff tagging in 2020 improved tag coverage of red drum below and at the lower end of the slot. The mean FL of red



drum tagged by cooperative anglers was 600 mm, while the mean FL was 382 mm for staff tagging.

#### **4.4 Total Fishery Removals**

Aggregated northern stock removals are presented in units used in the assessment models, metric tons for commercial landings and numbers for all other sources (Figure 72). Commercial landings have been steady to decreasing, with a high degree of interannual variability, throughout the assessment period. Landings peaked in the late-1990s at a 3-year average of 144 mt (1997-1999) though a 3-year minimum of 39 mt annually was observed only a few years later (2001-2003). From 2019-2021, annual landings were 78 mt. Commercial dead discard account for small proportions of removals. Since peaking in the late-1990s (3-year average of 0.10 million fish (1997-1998)), discards have declined, with a 3-year average of 5,625 dead discards from 2019-2022.

Recreational removals exhibited a decrease in the early-1990s, with 3-year average annual removals declining from 0.39 million fish (1986-1988) to 0.12 million fish (1994-1996), before beginning to increase again in the late-1990s. Northern stock recreational removals have exceeded removals observed in the late-1980s since the late-2000s, peaking at 1.06 million fish removed annually from 2011-2013. In the terminal 3-years (2019-2021), annual recreational removals were 0.92 million fish. The recreational fishery accounts for an increasing proportion of northern stock removals through time, accounting for greater than 90% of annual removals over the last ten years. These removals are increasingly represented by dead discards, averaging 37% of annual recreational removals over the last ten years.

All southern stock removals are used in assessment models in numbers. Southern stock fishery removal numbers aggregated among all sources show a decline from high levels during the late 1980s, a slow and steady increase through the 2000s, and an increase at an accelerated rate in the 2010s (Figure 73). Removals in the late 2010s are similar to levels in the early to mid-1980s, averaging 2,231,459 fish per year from 2015-2019. There was a decline in removals in recent years, but levels remain high. Generally, Florida accounts for the largest proportion of removals through time, followed by South Carolina, and Georgia. These contributions have been relatively consistent since 2000, averaging 22%, 19%, and 59% contributions, on average, by South Carolina, Georgia, and Florida, respectively. The most notable divergence was the large proportion of removals accounted for by Georgia in the final year of the time series (2022). Recreational dead discards accounted for very small proportions of the total removals in the early 1980s (<3%), but accounted for an increasing proportion of total removals through the mid-2000s. Dead discards accounted for a relatively consistent proportion of total removals from 2005 through 2018, averaging 27% of annual total removals. Dead discard contributions then increased again in the final five years of the time series, averaging 31% of annual removals, with state specific dead discards representing 37%, 18%, and 35% of removals in South Carolina, Georgia, and Florida, respectively.

## **5 FISHERY-INDEPENDENT DATA SOURCES**

Twelve fishery-independent surveys have been used in past red drum stock assessments or the simulation assessment to provide indices of relative abundance. Three surveys monitoring the northern stock have been used including one indexing recruitment, one indexing primarily sub-adult abundance, and one indexing mature abundance. Nine surveys monitoring the southern stock have been used including three indexing recruitment, three indexing primarily sub-adult abundance, and three indexing mature abundance. Indices of relative abundance and associated composition data were generated from these twelve surveys for use in this assessment. One additional survey monitoring the southern stock, the South Carolina Electrofishing Survey, was also considered in this assessment as an additional measure of sub-adult abundance. The nomenclature included in parentheses next to each full survey name in the following section is used when referring to them in the assessment methods sections (Sections 6-8).

### **5.1 North Carolina Bag Seine Survey (NC\_BagSeine)**

#### **5.1.1 Data Collection and Treatment**

A red drum bag-seine survey offers complete survey coverage of 120 seine sets per year. Only in 1994 and 1999 did the number of seine sets fall below 100.

##### **5.1.1.1 Survey Methods**

The survey was conducted at 21 fixed sampling sites throughout coastal North Carolina (Figure 74) during September through November each year from 1991 through 2022. Each of these sites was sampled in approximately two-week intervals for a total of six samples with an 18.3 m (60 ft) x 1.8 m (6 ft) beach seine with 3.2 mm (1/8 in) mesh in the 1.8 m x 1.8 m bag. One “quarter sweep” pull was made at each location. This was done by stationing one end of the net onshore and stretching it perpendicularly as far out as water depth allowed. The deep end was brought ashore in the direction of the tide or current, resulting in the sweep of a quarter circle quadrant. Salinity (ppt), water temperature (°C), tidal state or water level, and presence of aquatic vegetation were recorded. Locations of fixed stations were determined in 1990 based on previous catch rates and practicality for beach seining (Ross and Stevens 1992).

##### **5.1.1.2 Biological Sampling**

All red drum were identified, counted, and measured to the nearest mm FL.

##### **5.1.1.3 Catch Estimation Methods**

The size distribution of red drum caught during this survey indicated most fish were age-0. Given this, a size cutoff for age-0 was set at 100 mm FL and only fish <100 mm FL (i.e., age-0) were used in the index. The 100 mm cutoff was sufficiently bigger than the largest age-0 and smaller than any observed age-1 fish collected during the sample period.

Seven stations were not sampled throughout the entire period of the survey, so they were removed from further analysis. The juvenile index was developed using a generalized linear model (GLM), with Poisson and negative binomial error distributions considered. The models were examined for best fit using dispersions (Zuur et al. 2009) and Akaike's Information Criterion (AIC; Akaike 1974). The best fit model was developed using a negative binomial error distribution with year and station as covariates (Poisson: AIC= 43,751, df=47, dispersion= 22.0; negative binomial AIC=14,092, df=48, dispersion=1.4).

### **5.1.2 Trends**

Catch rates were variable early in the survey with apparent strong year classes in 1991 and 1993 (Table 30, Figure 75). During 1999-2001 there was a consistent series of low annual catch rates followed by an increase through 2005, before another decrease from 2006-2009. A small increase occurred in 2011, but catch rates immediately decreased and remained low through 2014. Values have been increasing and variable through 2021 with an apparent strong recent year class in 2018.

### **5.1.3 Potential Biases, Uncertainty, and Measures of Precision**

The estimated standard errors for the standardized relative abundance were fairly consistent throughout the time period and ranged from 0.20 to 0.24. Hurricanes during 1996 caused extreme high and low water conditions and may have altered survey results. For this reason, it was recommended that the 1996 data point be deleted from the index.

## **5.2 North Carolina Independent Gill Net Surveys (NC\_GillNet)**

### **5.2.1 Data Collection and Treatment**

The NCDMF annually conducts a fishery-independent gill net survey in the Pamlico Sound and its tributaries, where it regularly encounters sub-adult red drum. This stratified-random gill net survey was designed to provide fishery-independent relative abundance indices for key estuarine species including red drum. Surveys in all regions use a stratified-random design. Strata are defined based on area and depth (greater or less than six feet).

#### **5.2.1.1 Survey Methods**

Sampling in Pamlico Sound proper (The Pamlico Sound Independent Gill Net Survey (PSIGNS)) was initiated in May of 2001. Sampling in the Neuse and Pamlico Rivers, referred to as the Rivers Independent Gill Net Survey (RIGNS), began in 2003 under the same sampling methodology. Since this time, both surveys have sampled continuously. Sampling locations are selected using a stratified random sampling design based on area and water depth (Figure 76). The PSIGNS was divided into eight areas: Hyde County 1 – 4 and Dare County 1 – 4. The RIGNS sampling area is divided into eight strata, four in the Neuse River (Upper, Upper-Middle, Middle-Lower, Lower) and four in the Pamlico River (Upper, Middle, Lower and Pungo River). Each areal strata was overlaid by a one minute by one minute grid (i.e., one square nautical

mile) with each grid classified into either a shallow (< 6 ft), deep ( $\geq$  6 ft) or both depth stratum based on bathymetric maps.

Each areal stratum is sampled twice a month. For each random grid selected, both a shallow and deep sample were collected. Sets in the Pamlico Sound were made over a part of the year in 2001 (237 sets), and thereafter were sampled between 300 and 320 sets per year. Sets in the Rivers (Pamlico, Pungo, and Neuse) were made over a part of the year in 2003 (156 sets) and thereafter were sampled between 304 and 320 samples per year. Sample areas and coverage included in the PSIGNS and RIGNS surveys from 2001-2022 are provided in Figure 76.

For each grid selected, both the shallow and deep strata are sampled with a separate array (or gang) of nets. An array of nets consists of 30-yard segments of 3, 3½, 4, 4½, 5, 5½, 6, and 6½ in stretched mesh webbing (240 yards of gill net). Catches from this array of gill nets comprise a single sample, with two samples (one for the shallow strata, one for the deep strata) collected for each sampling trip. Gear was typically deployed within an hour of sunset and fished the following morning with effort made to keep all soak times within 12 hours. The 12-hour soak time allowed for uniform effort across all samples.

Physical and environmental conditions, including surface and bottom water temperature (°C), salinity (ppt), dissolved oxygen (mg/L), bottom composition, as well as a qualitative assessment of sediment size were recorded upon retrieval of the nets on each sampling trip. All attached submerged aquatic vegetation (SAV) in the immediate sample area was identified to species and density of coverage was estimated visually when possible. Additional habitat data recorded included distance from shore, presence or absence of sea grass or shell, and substrate type.

#### **5.2.1.2 Biological Sampling Methods**

Red drum for each mesh size (30-yard net) in a sample are enumerated with an aggregate weight (nearest 0.01 kg) obtained. Individuals are measured to the nearest millimeter FL.

Age data are available for each year and region from the survey. However, these data were not randomly collected but were taken as needed to provide representative samples by length bin during each monthly period sampled. Data should be valuable for growth curves and to inform the model on the age of fish captured in the survey.

#### **5.2.1.3 Catch Estimation Methods**

The time series in the rivers differs from that in the Pamlico Sound, therefore the results have typically been analyzed separately by area to evaluate the full time series of data: 1) Hyde and Dare counties (PSIGNS) only, beginning 2001, and 2) Rivers (Pamlico, Pungo, and Neuse; RIGNS), beginning 2003. The two areas can be combined as a single index beginning in 2003 and this was recommended for the index in the assessment due to the broader spatial coverage while only losing the two early years of data from the Pamlico Sound alone. The CPUE represents the number of red drum captured per sample. A collection represents one array of nets (shallow and deep combined) fished for 12 hours. Due to disproportionate sizes of each stratum and

region, the final CPUE estimate is weighted by aerial extent of strata with areas quantified using the one-minute by one-minute grid system.

Red drum catches in the survey vary across months. Due to this difference, only September, October, and November sets were used to develop a standardized index. A generalized linear model was constructed, with Poisson and negative binomial error distributions considered. The models were examined for best fit using dispersions (Zuur et al. 2009) and Akaike's Information Criterion (AIC; Akaike 1974). The best fit model was developed using a negative binomial error distribution with year and station as covariates (Poisson: AIC= 22,739, df=44, dispersion= 8.9; negative binomial AIC=11,846, df=27, dispersion=1.8).

### **5.2.2 Trends**

The standardized relative abundance showed a variable trend over the time series with the highest value occurring in 2012 (Table 30). Sampling was not conducted in 2020 due to COVID-19 impacts.

Red drum encountered by this survey were primarily between 28 and 70 cm (Figure 77).

### **5.2.3 Potential Biases, Uncertainty, and Measures of Precision**

Standard errors are presented for the annual estimates of standardized relative abundance (Table 30). Standard errors were relatively low (<0.2) for most years.

## **5.3 North Carolina Adult Longline Survey (NC\_Longline)**

### **5.3.1 Data Collection and Treatment**

The North Carolina Adult Longline Survey is a stratified-random survey occurring annually in Pamlico Sound that is designed to provide a fishery-independent relative abundance index for adult red drum in North Carolina. The survey has used continuous standardized sampling since 2007. The survey is designed to collect 72 stratified-random sets per year over a 12-week period from mid-July to mid-October.

#### **5.3.1.1 Survey Methods**

This survey employs a stratified-random sampling design based on area and time. Areas chosen for sampling were based on prior NCDMF mark and recapture studies, which indicate the occurrence of adult red drum within Pamlico Sound during the months of July through mid-October (Burdick et al. 2007; Bacheler et al. 2009). The sample area was overlaid with a one-minute by one-minute grid system (equivalent to one square nautical mile). Grids across the area were selected for inclusion in the sampling universe if they intercepted with the 1.8 m (6 ft) depth contour based on the use of bathymetric data from National Oceanic and Atmospheric Association (NOAA) navigational charts and field observations. Other factors, such as obstructions, accessibility, and logistics, were considered when grids were selected. Finally, the sample area was divided into twelve similarly sized regions (Figure 79). Two samples were

collected from each of the twelve regions during each of three periods from mid-July to mid-October.

A standardized sampling protocol that is replicated each year has been consistently utilized in the survey since 2007. All sampling was conducted using bottom longline gear. Lines were set and retrieved using a hydraulic reel. Ground lines consisted of 227 kg (500 lb) test monofilament. Samples were conducted with a 1,500-meter mainline with gangions placed at 15-meter intervals (100 hooks/set). Stop sleeves were placed at 30 m intervals to aid in accurate hook spacing and to prevent gangions from sliding down the ground line and becoming entangled when large species were encountered. Terminal gear was clip-on, monofilament gangions consisting of a 2.5 mm diameter stainless steel longline clip with a 4/0 swivel. Leaders on gangions were 0.7 m in length and consisted of 91 kg (200 lb) monofilament rigged with a 15/0 Mustad tuna circle hook. Hooks were baited with readily available baitfish (striped mullet is the primary bait and longline squid is the first alternative). Sets were anchored and buoyed at each end. Anchors consisted of a 3.3 kg window sash weight. Multiple sash weights were used in high current areas. All soak times were standardized and kept as close to 30 minutes as logistically possible. Soak times were measured from the last hook set to the first hook retrieved. Short soak times were designed to minimize bait loss, ensure that the red drum were tagged in good condition, and to minimize negative impacts to any endangered species interactions.

Within each randomly selected grid, two samples are taken. In order to maintain consistency, all samples were made in the vicinity of the 1.8 m depth contour with sample depths typically ranging from 1.2 to 4.6 m in depth. All random sampling occurred during nighttime hours starting at sunset. On average, a total of four sets were made per night.

Physical and environmental conditions, including surface and bottom water temperature (°C), salinity (ppt) and dissolved oxygen (mg/L), were recorded for each longline sample. Bottom composition and sediment size were recorded in the instances where they could be ascertained. Location of each sample was noted by recording the beginning and ending latitude and longitude.

#### **5.3.1.2 Biological Sampling Methods**

All individuals captured were processed at the species level and were measured to the nearest millimeter for both FL or TL and the presence or absence of drumming was noted. Most red drum were tagged (PIT and stainless-steel dart) and released, but a random sample including approximately every fifth fish collected was sacrificed for biological data collection, including the removal of otoliths for ageing.

#### **5.3.1.3 Catch Estimation Methods**

Catch rates were calculated annually, along with corresponding length class distributions. Since the model occurs on a fishing calendar from September through August, and the longline survey is the measure of the spawning individuals from July through October, all data from July

and August was bumped 1 fishing year to keep spawning aggregations in the same model year. The overall index is a standardized mean of the number of red drum captured per sample with environmental covariates taken into account. Longline sets were standardized to 100 hooks set at 15 m intervals for 30 minutes (measured as time elapsed from last hook set to first hook fished). The standardized index was estimated using a GLM approach, with Poisson and negative binomial error distributions considered. The models were examined for best fit using dispersions (Zuur et al. 2009) and Akaike's Information Criterion (AIC; Akaike 1974). The best fit model was developed using a negative binomial error distribution with year, grid, depth, bottom temperature, salinity, and DO as covariates (Poisson: AIC= 7,824, df=49, dispersion= 6.5; negative binomial AIC=4,798, df=31, dispersion=1.0).

### **5.3.2 Trends**

The index of relative abundance from 2007 to 2018 varied annually with little trend (Table 30 and Figure 80). The index value for 2022 was the lowest in the time series. It should be noted that the survey in 2019 was disrupted significantly by hurricane activity that occurred during the peak of the sample period and 2019 had a low relative abundance. The index value in 2018 was the highest of the time series. Sampling was not conducted in 2020 due to COVID-19 impacts.

The lengths of red drum captured ranged from 62 to 136 cm FL with most being between 86 and 114 cm FL. Length composition was similar across years (Figure 81).

Red drum ages collected from the survey ranged from age 3 to age 43 (Figure 82). Aggregated ages across all years of the survey plotted by year class (cohort) show the persistence of strong year classes (e.g., 1973, 1978, 1993, 2005) and weak year classes (e.g., 1977, 1988-1989, 1992, 2001-2002, 2009-2010) in the population over time (Figure 83). This trend appears consistent with variability in recruitment of YOY measured by the NC\_BagSeine survey.

### **5.3.3 Potential Biases, Uncertainty, and Measures of Precision**

Standard errors are presented for the standardized relative abundance and ranged from 0.20 to 0.27 (Table 30). The geographic range of the survey is limited to Pamlico Sound.

## **5.4 South Carolina Rotenone Survey (SC\_Rotenone)**

### **5.4.1 Data Collection and Treatment**

In the mid-1980s, the SCDNR began the development of long-term fishery-independent monitoring programs designed to monitor estuarine and coastal finfish populations along coastal South Carolina. One of these surveys, the Inshore Fisheries Rotenone Survey was designed to provide a survey of the estuarine finfish inhabiting estuarine, sub-tidal saltmarsh creek habitats. These creeks are less than 5 m wide and less than 1 m deep an hour before low tide; these habitats dominate the coastal South Carolina marsh environment. The survey was designed to provide relative abundance indices for key estuarine species, including red drum, as

the habitat sampled serves as a primary nursery habitat for a host of recreationally important estuarine species.

#### **5.4.1.1 Survey Methods**

Collections were made by blocking a 50 m long section of tidal creek with two 0.8 mm square mesh block nets, one at the upstream end of the section and one at the downstream end, about 1 hour before locally predicted time of low tide. The nets, with heavily weighted foot ropes, were suspended through the water column on lines stretched between poles sunk in the creek on opposite banks of the creek. Rotenone (100-200 ml of 5% Fish Tox, Wolfolk Chemical Works, Fort Valley, GA) was added at the upstream net and carried through the site with the ebbing current. At the down-stream net, potassium permanganate was added to the water leaving the site to oxidize the rotenone, thereby minimizing extra-site mortality. Immediately prior to the addition of rotenone, water temperature was measured with a stem thermometer and salinity was estimated with a refractometer. Dissolved oxygen was estimated with titration kit. Fish were collected within the site with dip nets and three pulls of a 3.2 mm bar mesh seine. The down-stream net was then carefully collected and those fish caught in it were removed. All specimens were returned to the lab for identification, enumeration, and measurement.

The SCDNR rotenone survey employed a fixed station sampling design. From 1986 through 1988, 7 sites, two in the ACE Basin estuary, 1 in the North Edisto and Stono River estuary, and 4 in the Charleston Harbor estuary were regularly sampled in at least two of the three years (Table 32). Beginning in 1989 through the end of the survey in 1994, sampling was conducted at 4 index stations in the Wando River Drainage, part of the Charleston Harbor estuary, in Charleston County, SC: Deep Creek, Foster Creek, Lachicotte Creek (sampled in 1986-1988), and PITA Creek (sampled in 1986-1988; Table 32).

#### **5.4.1.2 Biological Sampling**

Given the nature of the sampling procedure (rotenone) all collected fish were sacrificed and many were returned to the lab for final enumeration and the collection of biological information. Biological information for red drum included TL, SL, and weights with age determined based on length of capture. Owing to the small size of red drum encountered in the survey, there is limited information on sex with all encountered fish being considered immature.

A summary of the life history information provided to the benchmark assessment from the SCDNR rotenone survey is found in Table 33. Most individuals were exclusively aged based on size alone, as the survey encountered red drum prior to significant overlap in length distribution of individual cohorts, with near 100% certainty in the age determination of age-0 and age-1 fish (Figure 84). During the history of the survey, only 1 fish >1 year old was encountered, indicating that this survey represents a survey of red drum recruitment.



### 5.4.1.3 Catch Estimation Methods

During SEDAR 44, the SCDNR rotenone survey was presented as an age-0 index using data from September-December and an age-1 index using data from March-July, with the latter being primarily considered. However, the survey in actuality represents recruitment of red drum and can be readily converted to a survey of red drum year class strength, noting that young of the year red drum first recruit to the survey shortly after being born during the late summer and early fall and then persist in the survey through the winter, spring, and summer of the following year as calendar age-1 fish (Table 34). Under this treatment, there is no need for the development of age or length compositions, as it is assumed to be a survey of recruitment (e.g., year class strength) with a sampling year of August-July.

Under this framework, this recruitment index was standardized using a negative binomial generalized additive model (NB GAM) with year class (discrete), fixed sampling site (discrete), sampling stratum (discrete), a year class by fixed sampling site interaction term (discrete), a year class by sampling stratum interaction term (discrete), day of year (continuous; 9/1 = day 1), water temperature (°C, continuous) and salinity (PSU, continuous) being considered as potential covariates. Continuous covariates were fitted using a smoother using a cubic regression spline smoothing basis (Wood 2011; Wood 2017). Prior to model development any collections identified by the data provider as not suitable for use for index development were removed from consideration. Through investigation of all combinations of considered covariates, Bayesian Information Criterion (BIC) selected the best fit model,

$$\text{Catch} = \text{Year Class} + s(\text{DOY}, \text{bs} = ' \text{cr}' ) + s(\text{Temp}, \text{bs} = ' \text{cr}' ) + s(\text{Salinity}, \text{bs} = ' \text{cr}' ) + 1.$$

Year class effects were estimated using the best fit model using estimated marginal means using the *emmeans* package in R (Lenth 2023).

### 5.4.2 Trends

The SCDNR rotenone survey indicates above survey average recruitment of red drum in 1985, 1986, and 1990 (Table 35 and Figure 85). In other years, the abundance of red drum in the survey was reduced, with a stable to slightly decreasing trend in year class strength through time.

### 5.4.3 Potential Biases, Uncertainty, and Measures of Precision

The SCDNR rotenone survey was a fixed station survey with a limited number of sites (n = 9) with only a single site being sampled in all years (Table 32). Most sites sampled occurred in one river drainage along coastal South Carolina, the Wando River in Charleston Harbor. Further, the temporal duration of the survey was short, representing the catch of only eight red drum year classes from 1985-1993. Additionally, the SCDNR rotenone survey exhibits high relative standard errors (RSEs), with an average RSE of 0.55 (range: 0.43-0.77; Table 35).

That said, the survey represents a true recruitment index and correlates well with other contemporary surveys operating at the same time with reasonable measures of precision while covering a temporal period not covered by most other surveys. Further, the effect of sampling site and stratum on catchability was investigated through the standardization model, with neither variable being retained in the final best fit model suggesting synchrony in year class signals across space, as suggested by Arnott et al. (2010). The lack of a significant effect of site or stratum in the best fit index standardization model reduces the concerns surrounding the fixed station design.

## **5.5 South Carolina Stop Net Survey (SC\_StopNet)**

### **5.5.1 Data Collection and Treatment**

The second survey SCDNR began developing in the mid-1980s that encountered red drum was the Inshore Fisheries Stop Net Survey. This survey was designed to provide relative abundance indices for key estuarine species, including red drum, using salt marsh edge habitats. The survey indexed the relative abundance of numerous species and has been used in previous assessments of the southern stock of red drum.

#### **5.5.1.1 Survey Methods**

The stop net was 366 m long by 3 m deep with a 51 mm stretch mesh block net made of multifilament nylon mesh. The net was set at high tide in an intertidal area. One end was attached to a stake driven into the marsh surface, and then the net was laid out from a boat over the non-vegetated bottom parallel to the shore before securing the other end in the marsh with another stake. Upon deployment, the net enclosed a roughly semicircular area of approximately 12,000 m<sup>2</sup>. Fishes trapped in the enclosed area were collected with large dip nets as the tide dropped and selected species, including red drum, were placed in oxygenated holding tanks and held until they could be measured, tagged, and released, or retained for life-history workup. Immediately after net deployment, water temperature was measured with a stem thermometer and salinity was estimated with a refractometer. Dissolved oxygen was estimated with a titration kit.

Stop net sampling took place from 1985 through 1998, but monthly survey sampling occurred at a single site in Charleston Harbor (Grice Cove) from the summer of 1986 through 1993, with most months sampled in 1994 (Table 35). A secondary site in northern Bulls Bay (Bull Island) was sampled primarily during summers from 1990 through 1994, with a smattering of additional sites sampled throughout the survey history (Table 35). As such, only collections made at these two fixed stations were considered when developing the index.

#### **5.5.1.2 Biological Sampling**

Life history sampling of priority species, including red drum, was performed through the application of length distribution subsampling, with the number sacrificed for life history studies varying depending on species. Sacrificed red drum had additional biological variables ascertained (e.g., weight (g) and macroscopic reproductive stage) and biological samples

retained (e.g., otoliths for age and growth studies, scales for age and growth studies and ageing methodology comparisons, gonad tissues for histological determination of reproductive status, and muscle tissues for contaminant analysis).

A summary of the length and weight information provided to the simulation assessment from the SCDNR stop net survey is found in Table 33. A combination of age methodologies was used to age red drum encountered by the SCDNR stop net survey, dependent on the size of the individual fish. Smaller individuals (less than 2.5 years old), prior to significant overlap in length distribution of individual cohorts, can be reliably aged exclusively using TL, with near 100% certainty in the age determination of biological age-0 and -1 fish, as verified by otolith thin-section methodology (Figure 84). The ages of larger, and hence generally older, individuals have been determined via a combination of scale readings and otolith thin-section techniques, though all scale derived ages were excluded from consideration during the assessment.

### 5.5.1.3 Catch Estimation Methods

While the SCDNR stop net survey was included as an index during SEDAR 44, it was presented as an age-1 relative abundance index, with age-1 catch (based on a calendar year definition) in the survey occurring from Jul-Dec annually. They used this framework as there was a need for age-specific indices in the historical custom statistical catch-at-age model used to assess the southern stock. Herein, the SAS decided to use age-aggregated indices, where appropriate, with accompanying length-, age- or conditional age-at-length-compositions.

Under this framework, this sub-adult index was standardized using a negative binomial generalized additive model (NB GAM) with fishing year (discrete; 1986-1993), fixed sampling site (discrete), day of year (continuous; 9/1 = day 1), water temperature (°C, continuous) and salinity (PSU, continuous) being considered as potential covariates. Continuous covariates were fitted using a smoother using a cubic regression spline smoothing basis (Wood 2011; Wood 2017). Prior to model development, data was subset to only include collections made at the Grice Cove and Bull Island sites (Table 36). In addition, any collections identified as not suitable for use for index development were removed from consideration. Through investigation of all combinations of considered covariates, Bayesian Information Criterion (BIC) selected the best fit model,

$$Catch = Year + s(DOY, bs = 'cr') + 1.$$

Fishing year effects were estimated using the best fit model using estimated marginal means using the *emmeans* package in R (Lenth 2023).

Length compositions for the survey were developed from the observed TL measurements made on all individuals encountered by the survey, with both annual (calendar year and fishing year) and seasonal (2-season (Sept-Feb. & Mar.-Aug.) and 3-season (Sept.-Dec., Jan-Apr., & May-Aug.)) compositions developed initially. There was no need for expansion of the length compositions given the survey sampling design. Compositions were developed using 2 cm length bins (e.g., 0-19 mm TL = 0 cm bin, 20-39 mm TL = 3 cm bin, etc.).

The SAS recommended use of the annual fishing year (September 1-August 31) compositions in the base model given the use of the fishing year as the annual time step, though preliminary effects of incorporation of the seasonal compositions on assessment model results were investigated. The all-years pooled length composition for the survey can be found in Figure 86. Modes in the pooled length composition reflect cohorts of red drum encountered by the survey, with the mode at 24-28 cm, 36-40 cm, and > 56 cm TL corresponding to age-0, age-1, and age-2+ red drum encountered by the survey.

Age compositions for the survey were developed using paired TL and age measurements made on all individuals encountered by the survey, with both annual (calendar year and fishing year) and seasonal (2-season (Sept.-Feb. & Mar.-Aug.) and 3-season (Sept.-Dec., Jan-Apr., & May-Aug.)) compositions developed initially. Annual age compositions for the survey were not directly available, owing to the stratified random sampling design used to select fish to sacrifice for age determination via otoliths. Thus, to develop annual marginal age compositions we used proportional odds logistic regression to develop smoothed annual age-length-keys (ALK) conditional on the model

$$Age = a * TL + b * Year + c,$$

where *Age* is an ordered (smallest to largest) observed integer, biological age based on otolith or length derived age estimates, *TL* is a 2-cm TL bin (see length compositions) and *Year* represents the fishing year of capture (Agresti 2002; Ogle 2018; Stari et al. 2010; Venables & Ripley 2002). The resultant best fit model was used to determine the biological age of all un-aged (e.g., un-aged or originally aged-via scales) red drum captured from the stop net survey for which a TL (and hence TL bin) was available. These smoothed ALK “aged” fish were then added to the fish directly aged to develop marginal age compositions for each fishing year.

The SAS recommended use of the annual fishing year (September 1-August 31) compositions in the base model given the use of the fishing year as the annual time step, though preliminary effects of incorporation of the seasonal compositions on assessment model results were investigated. The resultant all-years pooled marginal age composition for red drum can be found in Figure 87, which clearly shows the majority of fish captured in the survey are either age-0 or age-1, with fewer age-2, age-3, and age-4+ fish encountered.

In the stock synthesis framework, the model can also utilize conditional age-at-length information where information on aged fish in length bins (i.e., raw ALK) by year and survey can be directly incorporated into the model to inform selectivity, growth, and natural mortality. To facilitate the incorporation of conditional age-at-length information from the SCDNR stop net survey, raw age (length and otolith derived) and length information was provided to the benchmark assessment.

### 5.5.2 Trends

Overall, the SCDNR stop net survey shows a relatively stable abundance of sub-adult red drum along coastal South Carolina throughout the survey time series (Table 37 and Figure 88). The

SCDNR stop net survey exhibits moderate RSEs, with an average RSE of 0.26 (range: 0.24-0.29, Table 37).

Annual length compositions available from the SCDNR stop net survey shows individual cohorts of red drum (identified by modes) being encountered by the survey (Figure 89), with the peaks of the modes of the length compositions elucidating information on the formation of strong and weak year classes based on length alone. From the age compositions, we see that either age-0 (1985, 1986, 1989, & 1990 fishing years) or age-1 (the remaining fishing years) red drum were most commonly encountered by the survey, though in most years individuals of at least age-3 were observed (Figure 90).

### **5.5.3 Potential Biases, Uncertainty, and Measures of Precision**

The SCDNR stop net survey represents a single fixed station along coastal South Carolina over a relatively short time period (10 fishing years), limiting its utility as a coastwide index of relative abundance for the southern stock. In addition, there is low sampling intensity within a year at those fixed stations, owing to the time required for a single collection. Combined, these attributes lead to higher than desired measures of precision on annual estimates of relative abundance ( $RSE \bar{X} = 0.26$ , range = 0.24-0.29; Table 37). However, this survey is one of a select few that provides any information on the relative abundance of sub-adult red drum in the late-1980s and early 1990s.

## **5.6 South Carolina Trammel Net Survey (SC\_Trammel)**

### **5.6.1 Data Collection and Treatment**

The SCDNR established the SCDNR trammel net survey in the fall of 1990 as a survey of lower estuary, moderate- to high-salinity, salt-marsh edge and oyster reef habitats; these habitats dominate the coastal South Carolina estuarine shoreline environment. The survey was designed to provide relative abundance indices for key estuarine species including red drum, as the habitat sampled serves as a primary habitat for a host of recreationally important estuarine species. The survey indexes the relative abundance of numerous species throughout the five major estuaries found along the South Carolina coast (Figure 91) and has been used in numerous stock assessments as an index of relative abundance, including previous assessments of the southern stock of red drum.

#### **5.6.1.1 Survey Methods**

The SCDNR trammel net survey employs a stratified random fixed station sampling design. On each sampling day (one stratum is sampled day<sup>-1</sup>), 12-14 stations are selected at random (without replacement) from a current pool of 27 to 36 possible fixed stations stratum<sup>-1</sup>, with the exception that adjacent sites (unless separated by a creek or other barrier) cannot be sampled on the same day to avoid sampling interference. Field crews typically set at 10-14 of the randomly selected sites day<sup>-1</sup>, although weather, tide, or other constraints sometimes hinders this target.

Protocols for each individual trammel net set are temporally and spatially consistent since the implementation of the survey in the fall of 1990. Fish are collected using a 183 x 2.1 m trammel net fitted with a polyfoam float line (12.7 mm diameter) and a lead core bottom line (22.7 kg). The netting comprises an inner panel (0.47 mm #177 monofilament; 63.5 mm stretch-mesh; height = 60 diagonal meshes) sandwiched between a pair of outer panels (0.9 mm #9 monofilament; 355.6 mm stretch-mesh; height = 8 diagonal meshes). Staff set individual trammel nets (one site<sup>-1</sup> day<sup>-1</sup>) along the shoreline (10-20 m from an intertidal marsh flat, <2 m depth) during an ebbing tide using a fast-moving Florida mullet skiff, anchoring each end of the net on the shore or in shallow marsh habitat. Once set, the boat makes two passes along the length of the enclosed water body at idle speed (taking <10 minutes), during which time field personnel disturb the water surface with wooden poles to promote fish entrapment. Field staff then at once retrieve the net and place netted fish in a live well.

Once staff complete net retrieval at a site, they then identify to the species level and count all captured specimens (fish and crustaceans). For red drum and other recreationally important species (black drum, spotted seatrout, southern flounder, sheepshead, spot, Atlantic croaker, southern kingfish, etc.), field staff record lengths from every individual caught. For other species, staff take measurements from all individuals unless large catches occurred; in such instances, staff measure a sub-sample of twenty-five fish species<sup>-1</sup> from each trammel net collection. Staff record different length measurements depending on the species and catches, though staff record stretched total lengths (TL), fork lengths (FL), and standard lengths (SL) where possible. Staff release most fish (>95%) alive at the site of capture once they obtain length measurements. Any red drum greater than 350 mm TL released at the site of capture and not previously tagged are tagged, with tag type dependent on the size of the individual. Individuals between 350- and 549-mm TL are tagged with disc belly tags, and any greater than 549 mm TL are tagged with a steel shoulder tag.

Additional data collected during each collection includes location (site nested in stratum nested in estuary, latitude, and longitude) and a suite of physical and environmental variables. Physical and environmental variables recorded include depth (m), air temperature (°C), water temperature (°C), salinity (PSU), dissolved oxygen (mg L<sup>-1</sup>), and tidal stage.

Additional details in a visual format regarding the SCDNR trammel net survey can be found in an online video published by SCDNR ([https://youtu.be/d8\\_VNKIsFPQ?si=Fcs9hCWUQPqjiGdl](https://youtu.be/d8_VNKIsFPQ?si=Fcs9hCWUQPqjiGdl)).

At present, nine strata, from south to north, are surveyed: Colleton River (CT), Broad River (BR), ACE Basin (AB), Ashley River (AR), Charleston Harbor (CH), Wando River (LW), Muddy & Bulls Bays (MB), Romain Harbor (RH), and Winyah Bay (WB). These nine strata are found in the five primary South Carolina estuaries, Port Royal Sound (CT & PR), St. Helena Sound (AB), Charleston Harbor (AR, CH, LW), Cape Romain and Bulls Bay (ME & CR), and Winyah Bay (WB). Note however, the time series of sampling in each estuary has varied through time (Table 38). Limited historical data is also available from additional strata and areas within current strata but are excluded from the development of relative abundance indices due to temporal length of surveys in these areas.

From November 1990 through the 2022 fishing year, the SCDNR trammel net survey had made 27,226 collections along the South Carolina coastline, in the 9 contemporary strata and one historical strata (CR) that was split into two of the contemporary strata (MB & RH), of which 26,094 were initially available for the construction of the red drum index of relative abundance (Table 39).

#### **5.6.1.2 Biological Sampling Methods**

Life history sampling of priority species, including red drum, is performed through the application of length distribution subsampling, with the number sacrificed for life history studies varying depending on the species. Sacrificed red drum (~300-500 per year) have several additional biological variables ascertained (e.g., weight (g) and macroscopic reproductive sex) and biological samples retained (e.g., otoliths for age and growth studies, scales for age and growth studies and ageing methodology comparisons, gonad tissues for histological determination of reproductive status, and muscle tissues for contaminant analysis).

A summary of the life history information provided to the benchmark assessment from the SCDNR trammel net survey is found in Table 33. A combination of age methodologies is used to age red drum encountered by the SCDNR trammel net survey, dependent on the size of the individual fish. Smaller individuals (<2.5 years old), prior to significant overlap in length distribution of individual cohorts, can be reliably aged exclusively using TL, with near 100% certainty in the age determination of calendar age-0 and 1 fish, as verified by otolith thin-section methodology (Figure 84). The ages of larger, and hence generally older, individuals have been determined via a combination of scale readings and otolith thin-section techniques, though all scale derived ages were excluded from consideration during the assessment.

#### **5.6.1.3 Catch Estimation Methods**

While the SCDNR trammel net survey was included as an index during SEDAR 44, it was presented as an age-specific calendar age-1 sub-adult index, an age-specific calendar age-2 sub-adult index, an age-aggregate calendar age 2-5 sub-adult index, and as a calendar age-aggregate index. The age-specific age-1 and age-2 indices were included in the final SEDAR 44 assessment model. They used this framework as there was a need for age-specific indices in the historical custom statistical catch-at-age model used to assess the southern stock. Herein, the SAS decided to use age-aggregated indices, where appropriate, with accompanying length-, age- or conditional age-at-length compositions.

Under this framework, this index was standardized to account for the impact covariates (Discrete: fishing year (1991-2022), stratum, stratum by year interaction, random (randomly selected = 1; non-randomly selected = 0), and tidal stage (early-ebb, mid-ebb, late-ebb); Continuous: day of year (9/1 = day 1), water temperature (°C), and salinity (PSU); Random: Site) had on collection level catchability of red drum. The inclusion of the “site” level random effect led to the investigation of a best fit model using either a negative binomial generalized additive model (NB GAM) or negative binomial generalized additive mixed model (NB GAMM) framework with fishing year as the primary variable of interest. Data was filtered to only retain fixed stations (e.g., “sites”) where we had captured red drum throughout the history of the

survey, only collections in ebb (early-, mid-, or late-ebb) tidal stages and those not missing continuous covariate data. Continuous covariates were fitted using a smoother using a cubic regression spline smoothing basis (Wood 2011; Wood 2017). In NB GAMM models, the site random effect was fit using a smoother using a ridge penalty which is equivalent to an assumption that the coefficients are independent and identically distributed random effects (Wood 2008). Through investigation of all combinations of considered covariates, BIC selected the best fit NB GAMM model,

$$Catch = Year + Stratum + Tidal Stage + s(DOY, bs = 'cr') + s(Site, bs = 're') + 1.$$

Fishing year effects were estimated using the best fit model using estimated marginal means using the *emmeans* package in R (Lenth 2023).

Length compositions for the survey were developed from the observed TL measurements made on all individuals encountered by the survey, with both annual (calendar year and fishing year) and seasonal (2-season (Sept.-Feb. & Mar.-Aug.) and 3-season (Sept.-Dec., Jan-Apr., & May-Aug.)) compositions developed initially. There was no need for expansion of the length compositions given the survey sampling design. Compositions were developed using 2 cm length bins (e.g., 0-19 mm TL = 0 cm bin, 20-39 mm TL = 3 cm bin, etc.).

The SAS recommended use of the annual fishing year (September 1-August 31) length compositions in the base model given the use of the fishing year as the annual time step, though preliminary effects of incorporation of the seasonal compositions on assessment model results were investigated. The all-years pooled length composition for the survey can be found in Figure 92. Modes in the pooled length composition reflect cohorts of red drum encountered by the survey, with the mode at 24-28 cm, 38-42 cm, and >58 cm TL corresponding to age-0, age-1, and age-2+ red drum encountered by the survey.

Age compositions for the survey were developed using paired TL and age measurements made on all individuals encountered by the survey, with both annual (calendar year and fishing year) and seasonal (2-season (Sept.-Feb. & Mar.-Aug.) and 3-season (Sept.-Dec., Jan-Apr., & May-Aug.)) compositions developed initially. Annual age compositions for the survey were not directly available, owing to the stratified random sampling design used to select fish to sacrifice for age determination via otoliths. Thus, to develop annual marginal age compositions we used proportional odds logistic regression to develop smoothed annual age-length-keys (ALK) conditional on the model

$$Age = a * TL + b * Year + c,$$

where *Age* is an ordered (smallest to largest) observed integer, biological age based on otolith or length derived age estimates, *TL* is a 2-cm TL bin (see length compositions) and *Year* represents the fishing year of capture (Agresti 2002; Ogle 2018; Stari et al. 2010; Venables & Ripley 2002). The resultant best fit model was used to determine the biological age of all un-aged (e.g., un-aged or originally aged-via scales) red drum captured from the trammel net



survey for which a TL (and hence TL bin) was available. These smoothed ALK “aged” fish were then added to the fish directly aged to develop marginal age compositions for each fishing year.

The SAS recommended use of the annual fishing year (September 1-August 31) age compositions in the base model given the use of the fishing year as the annual time step, though preliminary effects of incorporation of the seasonal compositions on assessment model results were investigated. The resultant all-years pooled marginal age composition for red drum can be found in Figure 93, which clearly shows the majority of fish captured in the survey are either age-0, age-1, age-2, or age-3, with fewer age-4 and age-5+ fish encountered.

In the stock synthesis framework, the model can also utilize conditional age-at-length information where information on aged fish in length bins (i.e., raw ALK) by year and survey can be directly incorporated into the model to inform selectivity, growth, and natural mortality. To facilitate the incorporation of conditional age-at-length information from the SCDNR trammel net survey, raw age (length and otolith derived) and length information was provided to the benchmark assessment.

### **5.6.2 Trends**

Overall, the SCDNR trammel net survey shows a decrease in abundance of sub-adult red drum along coastal South Carolina since the survey’s inception, only briefly offset by a period of good recruitment in the early 2000s (Table 40 and Figure 94). Record low abundances have been observed in recent years, though there has been a slight uptick since the 2019 fishing year.

Annual length compositions available from the SCDNR trammel net survey shows individual cohorts of red drum (identified by modes) being encountered by the survey, with the peaks of the modes elucidating information on the formation of strong and weak year classes (Figure 95). From the age compositions, we see that either age-0 (2000, 2015-2016), age-1 (1991-1992, 1994-1995, 1997, 2001-2002, 2007-2010, 2013-2014, and 2021), or age-2 (the remaining fishing years) red drum were most commonly encountered by the survey, though in most years individuals of at least age-3 were observed (Figure 96). Evidence of the strong 2000-year class shows up in the 2000 length and age compositions, which seems to support a temporary increase in relative abundance across the state, as observed in the index.

### **5.6.3 Potential Biases, Uncertainty, and Measures of Precision**

Overall, the SCDNR trammel net exhibits low RSEs, with an average RSE of 0.097 (range: 0.085-0.18; Table 40). Further, confidence in the index increases through time due to the expansion of the survey spatially leading to an increase in sampling intensity across the state. In addition, the long time series (32 years) provides the most comprehensive insight into the long-term trends in sub-adult red drum populations along coastal South Carolina.

## 5.7 South Carolina Historic Longline Survey (SC\_Longline\_historic)

### 5.7.1 Data Collection and Treatment

To monitor populations of adult red drum in South Carolina's estuarine and coastal ocean waters, a longline survey off of Charleston (Figure 97) was established in 1994. A primary focus of the survey was to develop an index of relative abundance of adult red drum to develop a better understanding of red drum populations along the southeastern Atlantic coast, thereby allowing for more effective and responsible management of the stock. As such, the survey collected data on the CPUE for indices of abundance and length measurements of all red drum encountered. Further, released red drum were tagged to collect migration and stock identification data.

#### 5.7.1.1 Survey Methods

In the first year of the study, a cable mainline (1,829 meter long) with one hundred hooks was deployed. Following discussion that sharks may be deterred by the cable (as sharks were also a target species), a 600-lb test, 1,829-meter monofilament mainline was also used with 120 hooks starting in 1995, and both gear types were used until 1997. In 1998, the survey switched to monofilament mainline for all sets, since it was concluded that while the cable gear decreased the catch of sharks, red drum catches were unaffected by the gear. Terminal tackle, regardless of mainline type, was composed of 0.5 m of 200 lb. test monofilament, with a 2.5 mm stainless steel longline clip affixing it to the mainline and a 15/0 Mustad circle hook. The hooks were primarily baited with Atlantic mackerel and spot, though bait used was not tracked at the collection level. Field crews targeted a 30-minute soak time (1st hook down to 1st hook up), though the overall retrieval time for the gear varied depending on the catch.

The majority of effort took place at index stations in Charleston Harbor (across 5 main fixed stations at the Charleston jetties or nearshore habitats off Charleston Harbor with live bottom; 0), with additional exploratory sets in Port Royal Sound in 2005 and in Winyah Bay and Port Royal Sound in 2006. Two vessels have been used since the survey began, the *R/V Anita* (1994-2004) and the *R/V Silver Crescent* (2005-2006). The mile-long (1,829 m) monofilament mainline was used until the survey design was modified in 2007 (with limited mile-long sets in 2007) from fixed sites to a stratified random design with 600-meter monofilament mainlines. Existing index stations were broken into three 600 m sets, and new stations were added based on suitable habitat and previous exploratory sets (see Section 5.9 for full contemporary description).

Within a year, sampling was conducted in each month of the year, though red drum catches were greater during the August-December period leading to a gradual increase in overall survey effort during this time frame. From 1994 to 2006, the SCDNR historic coastal longline survey made 1,083 collections that were used in the construction of the historic longline red drum index of relative abundance (Table 41).

### 5.7.1.2 Biological Sampling

Staff brought each fish captured on the longline on board where they removed the hook and measured each fish to the nearest mm FL (i.e., mid-line length) and TL. At the conclusion of initial workup, staff tagged and released each individual using three different tag types: nylon dart tag (1994-2006), PIT tag (2001-2006), and stainless-steel dart tag (2001-2006). In addition, staff took fin clips from all encountered red drum from 2003-2006 and a limited number of fish were sacrificed for age and reproductive status determination. A summary of the life history information provided to the benchmark assessment from the SCDNR historic longline survey is found in Table 33.

### 5.7.1.3 Catch Estimation Methods

Using only CPUE data on red drum collected during the months of August through December at the five fixed stations (i.e., “sites”) routinely sampled, the relative abundance index was standardized to account for the impact covariates (Discrete: fishing year (1994-2006), site, site by year interaction, and gear type (mono vs. cable mainline); Continuous: day of year (1/1 = day 1)) had on collection level catchability of red drum. The number of hooks was included as an offset term in the considered NB GAM models to account for differences in effort, with the best fit model chosen based on BIC. Continuous covariates were fitted using a smoother using a cubic regression spline smoothing basis (Wood 2011; Wood 2017). Through investigation of all combinations of considered covariates, the best fit NB GAM model was

$$Catch = Year + Site + s(DOY, bs = 'cr') + offset(\ln(hooks)) + 1.$$

Fishing year effects were estimated using the best fit model using estimated marginal means using the *emmeans* package in R (Lenth 2023).

Annual length compositions for the survey were developed from the observed TL measurements made on all individuals encountered by the survey. There was no need for expansion of the length compositions given the survey sampling design. Compositions were developed using 2 cm length bins (e.g., 0-19 mm TL = 0 cm bin, 20-39 mm TL = 3 cm bin, etc.). The all-years pooled length composition for the survey can be found in Figure 98.

Marginal age compositions for the historic longline survey were not developed owing to the small sample size of aged fish ( $n = 98$ ), the limited years where any fish were aged (1996, 2001, 2004-2006;  $n > 10$  aged only in 1996-1999), and the large number of year classes represented by the length composition for this adult survey. While attempts to develop marginal age composition using smoothed ALKs using proportional odds logistic regression modelling were made, the SAS did not recommend using the marginal age compositions in the assessment.

In the stock synthesis framework, the model can also utilize conditional age-at-length information where information on aged fish in length bins (i.e., raw ALK) by year and survey can be directly incorporated into the model to inform selectivity, growth, and natural mortality. To facilitate the incorporation of conditional age-at-length information from the SCDNR historic

longline survey, raw age (otolith derived) and length information was provided to the benchmark assessment.

### **5.7.2 Trends**

The SCDNR historic longline survey indicates a stable trend of adult red drum abundance throughout the time series (Table 42 and Figure 99). The exceptions were notably below average relative abundance in 1997 and 2000. The SCDNR historic longline survey exhibits moderate RSEs, with an average RSE of 0.19 (range: 0.16-0.33; Table 42). In addition, the survey provides the only insight into the long-term trends in adult red drum populations along coastal South Carolina from 1994-2006.

Annual length compositions available from the SCDNR historic longline survey shows little trend in the sizes of red drum being encountered by the survey (Figure 100). This is to be expected given the slowing of growth of adult red drum and the number of year classes over which the annual survey is integrating information over. Annual marginal age compositions are not presented as the SAS recommended not using age compositions developed for the historic longline survey (see Section 5.7.1.3).

### **5.7.3 Potential Biases, Uncertainty, and Measures of Precision**

Overall, the SCDNR historic coastal longline survey exhibits moderate RSEs, with RSEs ranging from 0.16-0.33 (Table 42). Further, it represents the only source of historical information on the abundance of mature, adult fish. However, the design of this survey (fixed station survey) and limited geographic scope (Charleston Harbor, SC, only) confounds the interpretation of relative abundance trends obtained. Further, there are potential sampling complications since the survey was modified from a survey designed to capture sharks initially. Though length information is available, the lack of age composition information from the survey may limit its ability to inform historic recruitment.

## **5.8 South Carolina Electrofishing Survey (SC\_Electro)**

### **5.8.1 Data Collection and Treatment**

The SCDNR established the SCDNR electrofishing survey in February 2001 as a survey of upper estuary (low salinity), river-bank waters which are important habitat for juvenile stages of fish (e.g., red drum, spotted seatrout, southern flounder, spot, and Atlantic menhaden). The survey indexes the relative abundance of numerous species throughout five tidally influenced freshwater riverine systems found along the South Carolina coast (Figure 91).

#### **5.8.1.1 Survey Methods**

The SCDNR electrofishing survey employs a stratified random fixed station sampling design. On each sampling day (one stratum is sampled day<sup>-1</sup>), 6-8 stations are selected at random (without replacement) from a pool of 72 to 208 stations stratum<sup>-1</sup>. Sampling stations within each stratum include sections of riverbank measuring a quarter of a nautical mile (~463 m). Field crews

typically conduct electrofishing at 5-6 of the randomly selected sites day<sup>-1</sup>, although weather, tide, or other constraints sometimes hinders this target. In particular, the field crew may need to shift up or downriver due to salinity fluctuations associated with drought or flood conditions as the boat-based electrofishing gear only works effectively at salinities < ~8 PSU. Hence the prior selection of more stations than can be sampled on a given day.

Protocols for each individual electrofishing set are temporally and spatially consistent since the implementation of the survey. We collect fish while running the electrofishing boat (Smith-Root) at ~3000 W pulsed direct current at a frequency of 120 Hz. SCDNR Inshore Fisheries staff place stunned fish into a live well using dip nets (4.5 mm square-mesh) over a 15-minute (900 s) period while the boat moves with the current at drift or idle speed along the riverbank. Once staff complete the 15-minute electrofishing pass along the riverbank, they then identify individuals to the species level and count all captured specimens. For red drum and other recreationally important species (e.g., spotted seatrout, southern flounder, sheepshead), field staff record lengths (in mm) from every individual caught. For other species, staff measure a sub-sample of twenty-five fish species<sup>-1</sup> for each electrofishing collection. Staff record different length measurements based on the species and catches, though staff record stretched total lengths (TL), fork lengths (FL), and standard lengths (SL) where possible. Staff release most fish (>95%) alive at the site of capture once they obtain length measurements. Any red drum greater than 350 mm TL released at the site of capture and not previously tagged are tagged, with tag type dependent on the size of the individual. Individuals between 350- and 549-mm TL are tagged with disc belly tags, and any greater than 549 mm TL are tagged with a steel shoulder tag.

Additional data collected during each collection includes location (site nested in stratum nested in estuary; latitude and longitude) and a suite of physical and environmental variables. Physical and environmental variables recorded include depth (m), air temperature (°C), water temperature (°C), salinity (PSU), dissolved oxygen (mg L<sup>-1</sup>), and tidal stage. In addition, boat settings for each individual electrofishing pass are typically recorded, including voltage (V; peak and average), current or amperes (A; peak and average), power (Watts (W); peak and average), current frequency (Hz), duty cycle (%), voltage range (e.g., 120/170), and percent frequency knob (setting on boat).

At present, five strata, from south to north, are surveyed: Combahee River (CM), Edisto River (LE), Ashley River (UA), Cooper River (UC), and Waccamaw/Sampit Rivers (EW). These five strata are found in three different estuarine systems, St. Helena Sound (CM and LE), Charleston Harbor (UA and UC), and Winyah Bay (EW). Note, however, the time series of sampling in each estuary has varied through time (Table 43). Limited historical data is also available from additional strata and areas within current strata but are excluded from the development of relative abundance indices due to temporal length of surveys in these areas.

From 1990 thru the 2022 fishing year, the SCDNR trammel net survey made 6,632 collections along the South Carolina coastline in the five contemporary strata (Table 44).

### 5.8.1.2 Biological Sampling Methods

Life history sampling of priority species, including red drum, is performed through the application of length distribution subsampling, with the number sacrificed for life history studies varying depending on the species. Sacrificed red drum have additional biological variables ascertained (e.g., weight (g) and macroscopic reproductive sex) and biological samples retained (e.g., otoliths for age and growth studies, scales for age and growth studies and ageing methodology comparisons, gonad tissues for histological determination of reproductive status, and muscle tissues for contaminant analysis).

A summary of the life history information provided to the benchmark assessment from the SCDNR electrofishing survey is found in Table 33. A combination of age methodologies is used to age red drum encountered by the survey, dependent on the size of the individual fish. Smaller individuals (<2.5 years old), prior to significant overlap in length distribution of individual cohorts, can be reliably aged exclusively using TL, with near 100% certainty in the age determination of calendar age-0 and 1 fish, as verified by otolith thin-section methodology (Figure 84). The ages of larger, and hence generally older, individuals have been determined via a combination of scale readings and otolith thin-section techniques, though all scale derived ages were excluded from consideration during the assessment.

### 5.8.1.3 Catch Estimation Methods

While the SCDNR electrofishing survey was included as an index during SEDAR 44, it was presented as an age-specific calendar age-1 sub-adult index. They used this framework as there was a need for age-specific indices in the historical custom statistical catch-at-age model used to assess the southern stock. The index was not included in the final model but was used as a corroborative index supporting the choice of other indices. It was noted to show good agreement with the SCDNR trammel net survey, with its primary reason for exclusion being it had a shorter time series than the SCDNR trammel net survey while providing the same signal (sub-adult calendar age-1 abundance) to the assessment model. Herein, the SAS decided to use age-aggregated indices, where appropriate, with accompanying length-, age- or conditional age-at-length compositions.

Under this framework, this index was standardized to account for the impact covariates (Discrete: fishing year (2001-2022), stratum, stratum by year interaction, random (randomly selected = 1; non-randomly selected = 0), tidal stage (early-flood, mid-flood, late-flood, high, early-ebb, mid-ebb, late-ebb, low), and voltage range (85, 170, 340 or 680); Continuous: day of year (9/1 = day 1), water temperature (°C), salinity (PSU), dissolved oxygen (mg L<sup>-1</sup>), percent knob setting (0-100%), and Secchi disk depth (m); Random: Site)) had on collection level catchability of red drum. The sampling duration (in minutes) was included as an offset term in the considered NB GAM and NB GAMM models to account for differences in effort. The inclusion of the “site” level random effect led to the investigation of a best fit model using either a NB GAM (no site random effect) or NB GAMM framework with fishing year as the primary variable of interest. Data was filtered to only retain fixed stations (e.g., “sites”) where we had captured red drum throughout the history of the survey and those not missing

continuous covariate data. Continuous covariates were fitted using a smoother using a cubic regression spline smoothing basis (Wood 2011; Wood 2017). In NB GAMM models, the site random effect was fit using a smoother using a ridge penalty which is equivalent to an assumption that the coefficients are independent and identically distributed random effects (Wood 2008). Through investigation of all combinations of considered covariates, BIC selected the best fit NB GAM model,

$$\text{Catch} = \text{Year} + \text{Stratum} + \text{Voltage Range} + s(\text{Percent}, \text{bs} = 'cr') + \text{offset}(\ln(\text{Duration})) + 1.$$

Fishing year effects were estimated using the best fit model using estimated marginal means using the *emmeans* package in R (Lenth 2023).

Length compositions for the SCDNR electrofishing survey were developed from the observed TL measurements made on all individuals encountered, with both annual (calendar year and fishing year) and seasonal (2-season (Sept-Feb. & Mar.-Aug.) and 3-season (Sept.-Dec., Jan-Apr., & May-Aug.)) compositions developed initially. There was no need for expansion of the length compositions given the survey sampling design. Compositions were developed using 2 cm length bins (e.g., 0-19 mm TL = 0 cm bin, 20-39 mm TL = 3 cm bin, etc.).

The SAS recommended use of the annual fishing year (September 1-August 31) length compositions in the base model, though preliminary effects of incorporation of the seasonal compositions on assessment model results were investigated. The all-years pooled length composition for the survey can be found in Figure 101. The primary mode in the pooled length composition at 38-42 cm corresponds to age-1 red drum encountered by the survey.

Age compositions for the survey were developed using paired TL and age measurements made on all individuals encountered by the survey, with both annual (calendar year and fishing year) and seasonal (2-season (Sept-Feb. & Mar.-Aug.) and 3-season (Sept.-Dec., Jan-Apr., & May-Aug.)) compositions developed initially. Annual age compositions for the survey were not directly available, owing to the stratified random sampling design used to select fish to sacrifice for age determination via otoliths. Thus, to develop annual marginal age compositions we used proportional odds logistic regression to develop smoothed annual age-length-keys (ALK) conditional on the model

$$\text{Age} = a * \text{TL} + b * \text{Year} + c,$$

where *Age* is an ordered (smallest to largest) observed integer, biological age based on otolith or length derived age estimates, *TL* is a 2-cm TL bin (see length compositions) and *Year* represents the fishing year of capture (Agresti 2002; Ogle 2018; Stari et al. 2010; Venables & Ripley 2002). The resultant best fit model was used to determine the biological age of all un-aged (e.g., un-aged or originally aged-via scales) red drum captured from the electrofishing survey for which a TL (and hence TL bin) was available. These smoothed ALK “aged” fish were then added to the fish directly aged to develop marginal age compositions for each fishing year.

The SAS recommended use of the annual fishing year (September 1-August 31) age compositions in the base model, though preliminary effects of incorporation of the seasonal compositions on assessment model results were investigated. The resultant all-years pooled marginal age composition for red drum can be found in Figure 102, which clearly shows the majority of fish captured in the survey are age-1, with fewer age-0, age-2, age-3, and age-4+ fish encountered.

### **5.8.2 Trends**

Overall, the SCDNR electrofishing shows a stable, if fluctuating abundance of red drum through the early-2010s survey, before a steady decline to record low abundances in the late-2010s (Table 45 and Figure 103). However, there was a stark rebound in relative abundance indicated in the terminal year of the index, indicating the potential for a strong 2021-year class.

Annual length compositions available from the SCDNR electrofishing generally show a primary mode associated with age-1 red drum encountered by the survey (Figure 104), with most fishing years exhibiting a clear mode at approximately 40 cm. However, in most years the survey encounters red drum ranging in size from <10 cm to >70 cm (Figure 104). From the age compositions, we see that age-1 fish are numerically dominant in all years of the survey, though fish ranging in age from 0 to 4+ years old were observed in most years (Figure 105).

### **5.8.3 Potential Biases, Uncertainty, and Measures of Precision**

Overall, the SCDNR electrofishing survey exhibits low RSEs, with an average RSE of 0.096 (range: 0.087-0.12; Table 45). This is comparable to the uncertainty measures obtained from the SCDNR trammel net survey. In addition, the long time series (22 years) and clear age-1 abundance signal provides additional insight into the long-term trends in sub-adult red drum and recruitment along coastal South Carolina.

## **5.9 South Carolina Contemporary Longline Survey (SC\_Longline\_contemporary)**

### **5.9.1 Data Collection and Treatment**

To monitor populations of adult red drum in South Carolina's estuarine and coastal ocean waters, the SCDNR began sampling using longlines in Charleston Harbor in 1994. Though the contemporary SCDNR adult red drum and shark coastal longline survey (i.e., SCDNR longline survey) traces its roots to this original historic survey, the survey was less standardized in the early years and underwent a significant modification prior to the 2007 field season. In its contemporary form, the survey samples the mouths of four South Carolina estuaries, Port Royal Sound, St. Helena Sound, Charleston Harbor, and Winyah Bay, and nearshore live bottom habitat, with fixed stations found along the edge of deep channels and at known red drum aggregation sites (Figure 91). A primary focus of the survey is to develop an index of relative abundance of adult red drum to develop a better understanding of adult red drum populations along the southeastern Atlantic coast, thereby allowing for more effective and responsible management of the stock. Information from this survey has also been used for coastal shark assessments across the region.



The primary objectives of the survey are to conduct fishery-independent longline sampling on adult red drum and coastal sharks to generate information on CPUE for indices of abundance. The survey also collects biological information (size, sex, etc.) and samples (otoliths, gonads, muscle, fin clips, etc.) from random sub-samples of the red drum catch to determine size-at-age, recruitment to the spawning population, and genetic composition of the stock. Further, released adult red drum (and some sharks) are tagged to collect migration and stock identification data.

#### 5.9.1.1 Survey Methods

With the 2007 field season, the SCDNR longline survey was redesigned to employ a stratified random fixed station sampling design. The survey samples four strata (Port Royal Sound, St. Helena Sound, Charleston Harbor, and Winyah Bay; Figure 91) during each of three six-week sampling periods (1 = Aug 1-Sept 15, 2 = Sept. 16-Oct 31, and 3 = Nov 1-Dec 15). The number of available stations for random selection per strata varies from 43-81: Port Royal Sound (78), St. Helena Sound (81), Charleston Harbor (43), and Winyah Bay (51). From this pool of stations, thirty are randomly selected for sampling from each stratum during each 6-week period, for an expected 120 collections per six-week sampling period and 360 collections field season<sup>-1</sup>.

Traditionally, all sampling for the SCDNR longline survey has been conducted aboard the *R/V Silver Crescent* using standardized gear. The exception was the 2022 field season when due to vessel damage to the *R/V Silver Crescent* from a hurricane the survey was moved to a smaller platform, the *R/V Regulator*. Longline gear consists of a 610 m monofilament mainline (272 kg test) with weights ( $\geq 15$  kg) and a 30.5 m buoy line attached at each end. The mainline is equipped with stop sleeves every 30 m (21 line<sup>-1</sup>) to prevent gangions from sliding together when a large fish is captured. The terminal tackle (gangions) is constructed of 0.5 m, 91 kg test monofilament leader, size 120 stainless steel longline snap, 4/0 swivel, and a 15/0 non-stainless-steel Mustad circle hook. Longlines were baited with Atlantic mackerel (*Scomber scombrus*), half Atlantic mackerel and half striped mullet (*Mugil cephalus*) for a bait study in Charleston Harbor (2011/2012), or all striped mullet, with forty gangions placed on each mainline.

For each set, the station location (site nested in strata, latitude/longitude, and location (inshore vs. offshore)) and gear code is recorded. When setting the gear, a start time (gear fully deployed) and end time (gear retrieval begins) of the set is noted for calculation of a set time (duration), in minutes. Gear was only set during daylight hours, and soak times for longline sets were limited to 45 minutes unless conditions or events dictated otherwise. A beginning and end depth is recorded at each station. Water quality (salinity (PSU), dissolved oxygen (mg L<sup>-1</sup>), water temperature (°C), tidal stage) and environmental conditions (air temperature (°C), percent cloud cover, wind direction, and wind velocity) are recorded at the end of each set.

From 2007 to 2022, the SCDNR coastal longline survey made 5,965 collections along the South Carolina coastline, of which 5,137 were used in the construction of the red drum index of relative abundance (Table 46).

### 5.9.1.2 Biological Sampling

Staff bring each fish captured on the longline on board, where they remove the hook, measure each fish to the nearest mm FL (i.e., mid-line length) and TL, weigh each fish to the nearest gram, and retain a fin tissue sample for genetic analysis. At the conclusion of initial workup, staff tag and release each individual or sacrifice the individual for age estimation and reproductive assessment. Each red drum not sacrificed receives two tags unless previously tagged: a nylon dart tag (Hallprint©) inserted in the dorsal musculature near the mid-point of the second dorsal fin at an angle toward the head and embedded in between the pterigiophores, and a PIT tag, which is inserted in the dorsal musculature near the origin of the soft rayed dorsal fin (second dorsal).

Red drum sacrificed for additional life history studies were randomly selected, with every  $n^{\text{th}}$  ( $n$  varies depending on system, catches and year) fish encountered, up to a maximum of ten fish daily, sacrificed. Staff ascertain and retain additional biological variables from sacrificed adult red drum (~100 per year), including otoliths for age determination, gonad tissues for histological determination of reproductive status, and muscle tissues for contaminant analysis. A summary of the life history information provided to the benchmark assessment from the SCDNR contemporary longline survey is found in Table 33. Red drum sacrificed for age from the SCDNR coastal longline survey have exclusively been aged via otolith thin-section techniques.

### 5.9.1.3 Catch Estimation Methods

During SEDAR 44, the SCDNR longline survey was included as an age-aggregated index of red drum abundance in the final assessment model, though steps were taken to allow combining of the historical data with the contemporary data stream. This included only using data collected at the Charleston Harbor “index” sites routinely sampled during the historical period, which allowed for the construction of a longer time series at the expense of discarding most contemporary data collected since 2007. The desire for combining the two timeseries was driven by the short length of the contemporary survey during the SEDAR 44 benchmark assessment. In addition, an *ad hoc*, external correction factor was applied to account for bait type effects on the nominal index developed (SEDAR 2015a). However, at the time they noted the RSEs of the survey were low, the combined index provided a long time series of adult relative abundance, and that the survey was the only information on abundance of mature, adult fish from the southern stock. Herein, the SAS decided to continue pursuing the use of the age-aggregated contemporary longline survey, with standardization techniques to account for the effect of bait type, instead of an *ad hoc* external correction, and other covariates affecting catchability.

Using only catch data on red drum collected during the months of August through December, the relative abundance index was standardized to account for the impact covariates (Discrete: fishing year (2007-2022), stratum, stratum by fishing year interaction, and bait type; Continuous: day of year (1/1 = day 1), water depth (m), water temperature (°C), and salinity (PSU); Random: site) had on collection level catchability of red drum. The inclusion of the “site” level random effect led to the investigation of a best fit model using either a NB GAM or NB

GAMM framework with fishing year as the primary variable of interest. Data was filtered to only retain fixed stations (e.g., “sites”) where we had captured red drum throughout the history of the survey. The number of hooks was included as an offset term in the considered NB GAM and NB GAMM models to account for difference in effort, with the best fit model chosen based on BIC. Continuous covariates were fit using a smoother using a cubic regression spline smoothing basis (Wood 2011; Wood 2017). In NB GAMM models, the site random effect was fit using a smoother using a ridge penalty which is equivalent to an assumption that the coefficients are independent and identically distributed random effects (Wood 2008). Through investigation of all combinations of considered covariates, BIC selected the best fit NB GAM model,

$$Catch = Year + Stratum + Bait Type + s(Water Temperature, bs = 'cr') + s(Day of Year, bs = 'cr') + offset(\ln(hooks)) + 1.$$

Fishing year effects were estimated using the best fit model using estimated marginal means using the *emmeans* package in R (Lenth 2023).

Annual length compositions for the survey were developed from the observed TL measurements made on all individuals encountered by the survey. There was no need for expansion of the length compositions given the survey sampling design. Compositions were developed using 2 cm length bins (e.g., 0-19 mm TL = 0 cm bin, 20-39 mm TL = 3 cm bin, etc.). The all-years pooled length composition for the survey can be found in Figure 106. Note, owing to the slowing of growth in adult red drum captured by this survey, there is little structure in the length composition to inform year class strength.

Age compositions for the survey were developed using paired TL and age measurements made on all individuals encountered by the survey. While annual age compositions for the survey were directly available due to the random age-sampling design employed by the SCDNR contemporary longline survey, we also used proportional odds logistic regression to develop annual age-length keys (ALK) conditional on the model

$$Age = a * TL + b * Year + c,$$

where *Age* is an ordered (smallest to largest) observed integer, biological age based on otolith or length derived age estimates, *TL* is a 2-cm TL bin (see length compositions) and *Year* represents the fishing year of capture (Agresti 2002; Ogle 2018; Stari et al. 2010; Venables & Ripley 2002), to develop marginal age compositions. The resultant best fit model was used to determine the biological age of all un-aged red drum captured from the contemporary longline survey for which a TL (and hence TL bin) was available. These smoothed ALK “aged” fish were then added to the fish directly aged to develop marginal age compositions for each fishing year. Note, however, that use of the smoothed ALK developed from the proportional odds logistic regression model led to less distinct year class signals in the marginal age compositions, with the benefit of providing a more robust age composition sample size as all un-aged fish were assigned a biological age.

The resultant all-years pooled marginal age composition, based on raw biological ages from the selected fish and the employment of the proportional odds logistic regression model, for red drum can be found in Figure 107. While the effect of the smoothed ALK does not appear to significantly affect the across years pooled age composition, it has a larger effect on apparent year class strength (Figure 108). While the expanded marginal age composition using the smoothed ALK shows the same general distribution of year classes, the magnitude of differences in individual year classes is muted relative to the raw marginal age compositions. In particular, the raw marginal age compositions hint at strong 1973-1974-, 1978-, 1984-, 1986-, 1990-, 2000-, 2001-, and 2006-year classes being captured by the contemporary longline survey. Signals of the strong 1991-, 2000-, 2001-, and 2006-year classes are also observed in the annual SCDNR trammel net marginal age compositions (Figure 96).

In the stock synthesis framework, the model can also utilize conditional age-at-length information where information on aged fish in length bins (i.e., raw ALK) by year and survey can be directly incorporated into the model to inform selectivity, growth, and natural mortality. To facilitate the incorporation of conditional age-at-length information from the SCDNR contemporary longline survey, raw age and length information was provided to the benchmark assessment.

### **5.9.2 Trends**

Overall, the survey suggests a stable to decreasing abundance of red drum along coastal South Carolina since 2007 (Table 47, Figure 107), with particularly low predicted adult abundance in 2010-2011 and 2021-2022. Outside of these years, the only other year deviating from the long-term average is 2009, which suggested higher red drum abundance than the rest of the time series (Figure 109).

Annual length- and age-compositions available from the SCDNR contemporary longline survey have more difficulty tracking individual cohorts of red drum encountered by the survey, which is not surprising given the size range and age-classes of adult red drum this survey intercepts (Figure 110 - Figure 112). Concerning is the decrease in the relative proportion of older fish in the longline survey since the mid-2010s (Figure 111), particularly given the declining numbers of sub-adult red drum encountered by the SCDNR trammel net survey (Figure 94). Further, there are indications that one can track strong year classes through the annual age compositions, particularly when using the raw annual marginal age compositions using fish randomly selected for sacrifice by the survey. This is particularly evident when tracking the 2000-year class in the years 2007, 2010, 2012, 2015, 2018-2020, and 2022 (Figure 111 - Figure 112); this year class likely was not observed in other years due to relatively limited sample size for aged fish.

### **5.9.3 Potential Biases, Uncertainty, and Measures of Precision**

Overall, the SCDNR contemporary longline survey exhibits moderate RSEs, with an average RSE of 0.20 (range: 0.17-0.28; Table 47). However, less effort in the 2007-2009 sampling seasons translates to increased uncertainty during this time block. Further, the effect of bait type on the

catchability of red drum introduces an additional source of uncertainty to annual estimates of relative abundance. As Atlantic mackerel was used exclusively in 2007-2009 and striped mullet from 2010-2019, this leads to caution when interpreting the CPUE across these years. However, a bait study conducted in Charleston Harbor in 2011 and 2012 allows analysts to develop correction factors (SEDAR 2015a; Murphy 2017) to minimize the impact bait type has on annual CPUE and the effect of bait type was directly incorporated into the standardization model herein. Further, this time series is growing in length, with the anticipation that the increased survey length will improve our understanding of abundance changes in the adult population that may manifest slowly as the survey integrates data over many age classes.

## **5.10 Georgia Gill Net Survey (GA\_GillNet)**

### **5.10.1 Data Collection and Treatment**

To determine red drum relative abundance, the gill net survey was conducted in Altamaha and Wassaw Sounds (Figure 113) from June through August 2003-2023.

#### **5.10.1.1 Survey Methods**

In the Altamaha River Region (Figure 114), 36 stations were sampled each month (June – August) from a pool of 60 total stations using a stratified random station design. In a given survey month, each selected station is sampled one time. In Wassaw Sound (Figure 115), 36 stations were selected and sampled from a pool of 70 total stations using a stratified random station design. The time series covers 2003-present.

All sampling occurred during the last three hours of ebb tide and only during daylight hours. Station pools in both survey areas were determined by initial surveys, which identified locations that could be effectively sampled with survey gear.

Survey gear is a single panel gillnet. The net is 91.4 m (300 ft) long by 2.7 m (9 ft) deep. The panel has 6.4 cm (2.5 in) stretch mesh. The net has a 1.3 cm (0.5 in) diameter float rope and a 34 kg (75 lb) lead line. A 11.3 kg (25 lb) anchor chain is attached to each end of the lead line, and a large orange bullet float is attached to each end of the float line.

A sampling event consists of a single net set. The net is deployed by boat starting at the bank following a semicircular path and ending back on the same bank. Net deployment is performed against the tidal current. Immediately after deployment, the net is actively fished by making two to three passes with the boat in the area enclosed by the net. After the last pass is made, the net is retrieved starting with the end that was first set out. As the net is retrieved, catch is removed and put inside a holding pen tied to the side of the boat. After the net is fully retrieved, all catch is processed for information and released. The catch is identified to species and counted. In addition to catch information, temporal, spatial, weather, hydrographic and physio-chemical data are collected during each sampling event.

#### **5.10.1.2 Biological Sampling**

All finfish specimens are measured to the nearest mm FL.

### 5.10.1.3 Catch Estimation Methods

Catches of target species were first separated into age cohorts by applying a standard monthly cutoff value to the length frequency information collected with each catch. Cutoff values vary among months for each species and were based on modal analyses of historical composite monthly length frequency data and reviews of ageing studies for each species. For the earlier months of the year, cutoff values were arbitrary values that fell in between discrete modal size ranges. In the later part of the year, when early spawned, rapidly growing individuals of the most recent year class may overtake late spawned and slowly growing individuals of the previous year class, cutoff values were selected to preserve the correct numeric proportionality between year classes despite the misclassification of individuals.

The extent of the zone of overlapping lengths and the proportion within that range attributable to each year class is estimated based on the shape of each modal curve during the months prior to overlap occurring. A length value is then selected from within that range which will result in the appropriate proportional separation. In the case of red drum, specimens collected during the survey most often represented age-1 fish, with 97% of all fish captured falling in the 220 to 350 mm range. Although this process involved considerable subjectivity and ignored possible interannual variability in average growth rates, there was little likelihood that any significant error was introduced as only a very small fraction of the specific aged cohort individuals fell within the zone of overlap. Most of the data used to construct juvenile indices were drawn from months when no overlap at all is present. Given the short sampling period of the gillnet sampling (June-August), all three months were used in these estimates.

Survey catch rate data were standardized in a model-based approach to account for variables affecting catchability. Net dimensions changed from a depth of six feet to nine feet in 2004, but the biologists on the survey indicated this change was unlikely to affect catchability because red drum are caught in the portions of the net unaffected by the change (i.e., net ends in one-three feet of water). Therefore, the entire time series of data was used for an index. Approximately forty five percent of the net sets observed positive red drum catches throughout the time series.

After checking available variables for collinearity and adequate sample sizes by level for categorical variables, variables selected for the standardization included depth, sound system, salinity, water temperature, dissolved oxygen, wind velocity, habitat type, and month. Year was retained to calculate the year effect (i.e., the annual index) and red drum catch per net set was used as the response variable.

A series of model types with negative binomial distributions including GLMs, GAMs, zero-inflated GLMs, and zero-altered GLMs were explored. GLMs and GAMs include one model component modeling the expected catch rates, while zero-inflated and zero-altered GLMs include second model components with binomial distributions modeling the probability of zero and non-zero (positive) catches. Model selection was made through evaluation of model fits for lack of overdispersion, evaluation of residual diagnostics for lack of residual patterns, and AIC comparisons. If a more parsimonious model was within two AIC units of the model with the

lowest AIC, the more parsimonious model was selected. Model selection started with comparison of model types using the full set of variables and indicated the zero-altered GLMs performed best. Zero-altered GLMs were then evaluated with the full set of variables and reduced sets of variables for both components of the models. Model selection criteria favored a final model with year, depth, sound system, salinity, habitat type, and month for the catch rate component and year, sound system, water temperature, wind velocity, habitat type, and month for the zero-inflation component.

The standardized index was calculated by extracting model-predicted year effects for each year while holding other variables in the model constant across years.

### **5.10.2 Trends**

The trend is stable through 2009, declines to lower levels in the early 2010s, and then increases back to levels observed prior to 2010 for most of the late 2010s and 2020s (Figure 116). The index increased to the highest observed value in the final fishing year of 2022.

One thing to keep in mind is that the gill net survey is designed to target juvenile red drum and the average size of fish caught in the survey is 282 mm FL. Essentially this survey is a measure of annual recruitment and is largely driven by spawning success and environmental effects on larval/juvenile fish survivability through the winter/spring. The index generally tracks well with annual MRIP estimates.

### **5.10.3 Potential Biases, Uncertainty, and Measures of Precision**

The final model was used in a bootstrapping analysis with 1,000 replicates to generate standard errors, SEs, and confidence intervals for the standardized index.

SEs are stable and vary slightly around an average of 0.21 throughout the time series (Table 31). The index with confidence intervals is shown in Figure 116.

Overall, the GA gillnet survey is a robust long-term standardized survey, designed specifically to target YOY red drum before they enter the fishery. The survey has been in continuous operation since 2003 and the survey design has remained relatively unchanged since its inception. Geographically the survey has historically included two primary regions (Wassaw and Altamaha). Recognizing that this could lead to an underrepresentation of statewide red drum trends, a third system (St. Andrew) was added in 2019. Data from the St. Andrew expansion is still preliminary and has not yet been included in the survey index. However, the addition of St. Andrew and any other future expansions should help improve statewide status estimates.

## **5.11 Georgia Longline Survey (GA\_Longline)**

### **5.11.1 Data Collection and Treatment**

The GADNR utilizes a near shore red drum bottom longline survey which encompasses state and federal waters off the coast of Georgia. This is a stratified-random study to develop fishery-

independent indices of abundance for multiple shark species and adult red drum occurring in state waters. Data gathered from this study is used to support long-term fishery-independent indices useful for assessing stock status and trends. Tagging of red drum and sharks captured during the study allows for additional information on migratory behavior and stock identification to be collected.

Since its inception in 2006, Georgia's longline survey has captured over 900 large, adult red drum (870 in Georgia waters), with 777 of those occurring in the months of September – December. For this assessment, Georgia's Longline CPUE was constrained to catch of red drum that only occurred in Georgia waters during the months of September – December to standardize the CPUE to that of other similar surveys throughout the region (SC & NC).

#### **5.11.1.1 Survey Methods**

Current sampling occurs in waters of Doboy Sound to St. Marys in Georgia from June to December. Stations are randomly chosen from a subset of sites identified as areas with high encounter probabilities. Three strata are delineated off Georgia (inshore; near shore; offshore) and sampling efforts are proportionally allocated to match the emigration pattern of adult red drum. All stations are sampled during daylight hours and are generally located in water depths between 13 and 65 feet. The longline is deployed from the *R/V Glynn*, a 47' offshore vessel. The mainline is made of 2.5 mm monofilament and is approx. 926 m in length. A total of 60 droplines are attached to the mainline, where each dropline consists of a longline snap, 1.5 ft of 200 lb. monofilament, and a 12/0 circle hook on the terminal end. Hooks are not offset and have barbs depressed. The total soak time is 30 minutes with hooks baited with mullet.

Beginning in 2018, sampling was broken up into 4, 6-week quarters. A minimum of 35 bottom-set longline stations are selected to be sampled in Georgia coastal waters each 6-week quarter (June 16 – July 31, Aug 1 – Sep 15, Sep 16 – Oct 31, Nov 1 – Dec 15).

#### **5.11.1.2 Biological Sampling**

All catch is processed at the species level. All red drum are landed and processed for standard morphometrics and genetic material (fin clip) when requested. Viable red drum are tagged with conventional dart and PIT tags and released. Mortalities are processed further for sex and gonadal development information, and otoliths are extracted for age determination. Periodically, a subsample of red drum may be sacrificed to estimate the adult stock age composition.

#### **5.11.1.3 Catch Estimation Methods**

For this assessment, to standardize CPUE to similar surveys in the region (SC & NC), Georgia's Longline index was constrained to catch that only occurred in Georgia waters in the months of September – December.

Survey catch rate data were standardized in a model-based approach to account for variables affecting catchability. There were only seven sets in 2020, so this year of data was dropped



from the data set. Approximately twenty five percent of the sets observed positive red drum catches throughout the time series.

After checking available variables for collinearity and adequate sample sizes by level for categorical variables, variables selected for the standardization included strata, water temperature, and weather conditions. Year was retained to calculate the year effect (i.e., the annual index) and red drum catch per set was used as the response variable.

The same approach for model exploration and selection as that described for the Georgia Gill Net Survey was used for this longline survey. Model selection started with comparison of model types using the full set of variables and indicated the zero-inflated GLMs performed best. Zero-inflated GLMs were then evaluated with the full set of variables and reduced sets of variables for both components of the models. Model selection criteria favored a final model with year, strata, and water temperature for the catch rate component and strata and water temperature for the zero-inflation component.

The standardized index was calculated by extracting model-predicted year effects for each year while holding other variables in the model constant across years.

#### **5.11.2 Trends**

The trend shows a slight increase throughout the time series (Figure 117).

The length compositions of red drum caught during the survey are in Figure 118.

#### **5.11.3 Potential Biases, Uncertainty, and Measures of Precision**

The final model was used in a bootstrapping analysis with 1,000 replicates to generate standard errors, SEs, and confidence intervals for the standardized index.

SEs follow a slight decreasing trend through time with an average of 0.31 across years (Table 31). The index with confidence intervals is shown in Figure 117.

In the early years of the survey different hook sizes and bait types were tested. In 2006 mackerel was the only bait type and a 15/0 hook was the only size hook used. In 2007, both mackerel and squid were the bait types used with a 15/0 hook. From 2008-2015 a combination of hook sizes was tested with squid only as bait. During that period, 50% of hooks were size 15/0 and 50% were size 12/0. From 2016-2020 mullet and squid were tested with size 15/0 hooks only. In 2020, vessel availability due to mechanical problems limited sampling activities. Beginning in 2021 the survey was tuned to replicate the South Carolina longline survey which included standardized hook size (15/0) and bait selection (mullet; Table 48)

## **5.12 Florida 21.3 Meter Haul Seine Survey (FL\_21.3\_HaulSeine)**

### **5.12.1 Data Collection and Treatment**

Indices of relative abundance for red drum were derived from surveys conducted by the Florida Fish and Wildlife Research Institute's Fishery Independent Monitoring (FIM) program in northeast Florida (lower St. Johns, Nassau, and St. Mary's River basins). Data from the northern portion of the Indian River Lagoon were initially considered, but were excluded from index development by the data workshop panel. The rivers and estuaries of northeast Florida are dominated by salt marshes and more closely resemble the estuaries and riverine systems of coastal South Carolina and Georgia (i.e., the rest of the southern region for red drum). In contrast, the Indian River Lagoon can be characterized as a broad transitional zone dominated by mangrove wetlands.

The 21.3-m center bag seine was used to develop an index of relative abundance for age-0 YOY red drum.

#### **5.12.1.1 Survey Methods**

The FIM program uses a stratified random sampling design to monitor abundances of fish and invertebrates. Survey areas were divided into sampling zones based upon geographic and logistical criteria where each zone was further subdivided into 1-nm<sup>2</sup> grids and randomly selected for sampling. Sampling grids were stratified by depth and habitat (defined by shore type [overhanging or not] and bottom vegetation [vegetated or not]) where a single sample was collected at each randomly selected site in shallow water  $\leq 1.8$  m. Environmental data consisting of water chemistry, habitat characteristics, and current and tidal conditions were recorded for each sample. In northeast Florida, sampling has been conducted year-round since May 2001.

#### **5.12.1.2 Biological Sampling**

All captured red drum were counted and a random sample of at least 20 individuals were measured in standard length (SL). If more than 20 red drum were encountered, then length frequencies of the 20 fish were expanded to the total number caught to estimate the sample catch length frequency.

#### **5.12.1.3 Catch Estimation Methods**

YOY were defined as red drum captured during the peak recruitment season of September through March and whose lengths were smaller than or equal to 40 mm SL. Cohorts were kept together such that fish caught in September through December were grouped with those caught January through March the following year. Prior to standardization, the data were subset to remove any months, zones, or strata that rarely encountered red drum.

Catch rates for this index were standardized using the delta lognormal model which split the process into two generalized linear sub-models (Lo et al. 1992). The first sub-model estimated the proportion of stations where red drum were observed. This sub-model used a binomial

distribution with a logit link. A separate sub-model with a gamma distribution and a log link was used to estimate the mean number of red drum caught at positive stations. The estimated coefficients were then back-calculated from their linearized form used in the modeling steps. The annual index is the product of the proportion of samples where red drum were observed and the mean number of red drum by year estimated from the positive model.

Potential explanatory variables included year, month, bottom vegetation, bottom type, shore type, bay zone, water temperature (°C), dissolved oxygen (mg/L), and salinity (ppt). All potential explanatory variables were treated as categorical variables partially to account for non-linearity. Beginning with the null model, forward stepwise selection was used to identify which variables should be included in the final versions of the sub-models. To be included in the final sub-model, variables had to meet two criteria: the variable must be statistically significant at an alpha level of 0.05 and its inclusion must reduce deviance (a measure of the variability) by at least 0.5%.

### **5.12.2 Trends**

The YOY index of relative abundance for red drum was variable but stable around a mean through 2011 with a strong year class in 2012. Abundance then decreased and became variable around a lower mean from 2013 through 2022 with another strong year class in 2021 (Table 31 and Figure 119). Weak year classes occurred in 2005, 2010, and 2018. Data for the 2022 fishing year were not available for the assessment.

### **5.12.3 Potential Biases, Uncertainty, and Measures of Precision**

To estimate variability in the annual index values (Table 31), a Monte Carlo simulation approach was used with 10,000 iterations using the least-squares mean estimates and their standard errors from the two generalized linear sub-models. Each iteration used the annual least-squares mean estimate on the log scale and uncertainty was added by multiplying the annual least-squares mean estimate's standard error by a random normal deviate ( $\mu=0$ ,  $s=1$ ). These values were transformed back from their linear scales prior to being multiplied together and the index derived was the product of the probability of observing a red drum during sampling and the annual average number of red drum counted at sites where this species was encountered.

## **5.13 Florida 183 Meter Haul Seine Survey (FL\_183\_HaulSeine)**

### **5.13.1 Data Collection and Treatment**

Indices of relative abundance for red drum were derived from surveys conducted by the Florida Fish and Wildlife Research Institute's Fishery Independent Monitoring (FIM) program in northeast Florida (lower St. Johns, Nassau, and St. Mary's River basins). As stated above, data from the northern and southern portions of the Indian River Lagoon were initially considered, but were excluded from index development by the data workshop panel.

The 183-m haul seine was used to develop an index of relative abundance for sub-adult red drum.

#### **5.13.1.1 Survey Methods**

The FIM program uses a stratified random sampling design to monitor abundances of fish and invertebrates. Survey areas were divided into sampling zones based upon geographic and logistical criteria where each zone was further subdivided into 1-nm<sup>2</sup> grids and randomly selected for sampling. Sampling grids were stratified by depth and habitat (defined by shore type [overhanging or not] and bottom vegetation [vegetated or not]) where a single sample was collected at each randomly selected site in shallow water  $\leq 1.8$  m.

Environmental data consisting of water chemistry, habitat characteristics, and current and tidal conditions were recorded for each sample. In northeast Florida, sampling has been conducted year-round since May 2001.

#### **5.13.1.2 Biological Sampling**

All captured red drum were counted and measured (SL). If five or fewer were captured within a single set, they were culled for further biological sampling including weight, sex, maturity, age, mercury content, and diet.

Red drum culled for further biological sampling had their otoliths removed and aged by FWRI's Age and Growth lab.

#### **5.13.1.3 Catch Estimation Methods**

Sub-adults were defined as red drum captured year-round whose lengths were larger than 180 mm SL. Prior to standardization, the data were subset to remove any months, zones, or strata that rarely encountered red drum.

Catch rates for this index were similarly standardized as the 21.3-m seine index using the delta lognormal model which split the process into two generalized linear sub-models (Lo et al. 1992). The first sub-model estimated the proportion of stations where red drum were observed. This sub-model used a binomial distribution with a logit link. A separate sub-model with a gamma distribution and a log link was used to estimate the mean number of red drum caught at positive stations. The estimated coefficients were then back-calculated from their linearized form used in the modeling steps. The annual index is the product of the proportion of samples where red drum were observed and the mean number of red drum by year estimated from the positive model.

Potential explanatory variables included year, month, bottom vegetation, bottom type, shore type, bay zone, water temperature (°C), dissolved oxygen (mg/L), and salinity (ppt). All potential explanatory variables were treated as categorical variables partially to account for non-linearity. Beginning with the null model, forward stepwise selection was used to identify which variables should be included in the final versions of the sub-models. To be included in the final sub-model, variables had to meet two criteria: the variable must be statistically significant at an alpha level of 0.05 and its inclusion must reduce deviance (a measure of the variability) by at least 0.5%.

### 5.13.2 Trends

The sub-adult index of relative abundance for red drum largely following a similar trend to the YOY index where abundance was variable through 2012 with high abundances in 2003, 2005, and 2009. Abundance was then low from 2013 – 2020, then increased again in 2021 (Table 31 and Figure 120). Data for the 2022 fishing year were not available for the assessment.

The survey primarily encountered subadult red drum living in the estuaries and rivers who recruited out of the 21.3 m seine as older age-0 fish through age 4 (Figure 122).

### 5.13.3 Potential Biases, Uncertainty, and Measures of Precision

To estimate variability in the annual index values, a Monte Carlo simulation approach was used with 10,000 iterations using the least-squares mean estimates and their standard errors from the two generalized linear sub-models. Each iteration used the annual least-squares mean estimate on the log scale and uncertainty was added by multiplying the annual least-squares mean estimate's standard error by a random normal deviate ( $\mu=0$ ,  $s=1$ ). These values were transformed back from their linear scales prior to being multiplied together and the index derived was the product of the probability of observing a red drum during sampling and the annual average number of red drum counted at sites where this species was encountered.

## 6 METHODS

Several analyses were developed through the course of this assessment. The primary analyses at the beginning of the assessment were the SS models and TLAs recommended during the simulation assessment. Additionally, a tagging model was developed with South Carolina tagging data as a complementary analysis providing mortality trends and to better utilize tag-recapture data available for the assessment, a recommendation of past SASs and RPs. Later on in the assessment, a data-limited method, Skate, was developed as a backup method in the case that stable SS models could not be developed to provide catch advice. The TLAs do not provide quantitative catch advice and are intended to be complementary analyses that provide qualitative stock status information.

### 6.1 Cormack-Jolly-Seber Tagging Model

#### 6.1.1 Background

The Cormack-Jolly-Seber (CJS) model is a standard tagging model used to estimate mortality rates from live encounter data of an open population experiencing births, deaths, and migration (Lebreton et al. 1992; Pollock et al. 1990). The CJS model uses forward-time modeling to estimate two key parameters: apparent survival ( $\Phi$  – the probability that an animal survives, including losses due to mortality and permanent emigration) corrected for the probability of encounter ( $p$  – the probability an animal is detected given it is available for encounter in the study area; Sandercock et al. 2020). For a sample consisting of  $n$  occasions, the CJS model calculates  $n-1$  estimates of  $\Phi$  and  $n-2$  estimates of  $p$ , whereby the apparent survival is estimated between occasions and encounter probabilities are estimated for each sampling

occasion. Importantly, this means encounter rates cannot be estimated for the first sampling occasion, and these two parameters are confounded on the last sampling occasion, only allowing for estimation of the product of the two parameters ( $\beta$ ). The CJS model requires capture histories from at least three sampling occasions and can be fit using a multinomial maximum likelihood estimation (Lebreton et al. 1992).

Model structure illustration:

$$\begin{matrix} 1 & \phi_1 & 2 & \phi_2 & 3 \\ & \rightarrow & & \rightarrow & \\ & & p_2 & & \beta_3 \end{matrix}$$

Encounter histories and corresponding probability statements:

Encounter history	probability
111	$\Phi_1 p_2 \beta_3$
110	$\Phi_1 p_2 (1 - \beta_3)$
101	$\Phi_1 (1 - p_2) \beta_3$
100	$1 - \Phi_1 p_2 - \Phi_1 (1 - p_2) \beta_3$

CJS model assumptions (Pollock et al. 1990) include:

1. Every marked animal in the population at sampling period  $i$  has the same probability of capture,
2. Every marked animal in the population at sampling time  $i$  has the same probability of survival until the next sampling period ( $i+1$ ),
3. Marks are not lost, overlooked, or mis-recorded,
4. Sampling periods are instantaneous, and releases are made immediately following sampling.

### 6.1.2 Data

Red drum were tagged as part of ongoing SCDNR fisheries-independent monitoring programs using a combination of SC\_Trammel (1990-present), SC\_Electro (2001-present), and SC\_Longline\_contemporary (2007-present) surveys. For a full description of the SCDNR tagging program and related protocols, please see Section 4.3 and Arnott et al. (2010). Sampling occurred along the South Carolina coast on a monthly basis throughout the year, but data were restricted to only include releases and recaptures from September – December (to satisfy assumption #4 above). Furthermore, tagging data were only examined from 1990-2022, with 2021 being the last year of releases considered. In addition, any fish eventually harvested or released without a tag after the initial release were omitted from analyses.

Due to potential heterogeneity in survival rates across fish ages, red drum were assigned age classes (1-3+) based on seasonal (monthly) age-length-keys developed by the SCDNR Inshore Fisheries Research Section.

### 6.1.3 Model specification and selection

All analyses were performed in the R Core environment (R Core Team 2021). Individual fish capture histories were generated using the 'capHistConvert' function in the 'FSA' package (Ogle et al. 2023). Prior to model analyses, goodness of fit (GOF) tests were performed on the data using the 'overall\_CJS' function in the 'R2ucare' package (Gimenez et al. 2018). Following the package author's recommendations, the data were first segmented by group (age) before overall\_CJS test were run. The overall\_CJS function aims at testing with contingency tables (and Fisher's exact test if needed) for the presence of transients (Pradel et al. 1997, 2003) and trap-dependence (Pradel 1993; Pradel et al. 2003). The result of this test suggested no such impacts of either effect were likely for any age group (Age 1 -  $\chi^2 = 40.879$ ,  $df=75$ ,  $p = 1.0$ ; Age 2 -  $\chi^2 = 50.556$ ,  $df = 69$ ,  $p = 0.9$ ; Age 3 -  $\chi^2 = 41.215$ ,  $df=49$ ,  $p = 0.8$ ). Accordingly, and following the package author's recommendation, we fit the data to a standard CJS model (Gimenez et al. 2018).

The CJS candidate models were generated using the R package 'marked' (Laake et al. 2013). Twenty-five candidate models were generated (Table 49). Estimated annual apparent survival probability was allowed to either be constant ( $\sim 1$ ), vary by age group, time, age group + time, or age group \* time. Similarly, encounter probability was modeled as either constant ( $\sim 1$ ), varying by age group, or by the varying survey initiating periods (1990-2000, 2001-2006, 2007-2022), as well as the additive effects of age group and survey period (age + period) and their interaction (age \* period). Of these candidate models, the 'best' model was selected based on the lowest AIC value. To aid in visualization of model results, if time was included as a predictor variable for  $\Phi$ , this term was smoothed using the 'bs' spline function in the 'splines' package (R Core Team 2024).

### 6.1.4 Results

A total of 24,555 red drum were released as a part of the SCDNR tagging program (with the above described data filtering processes), with 638 individuals recaptured at least once in subsequent years. The majority ( $n=609$ ) of recaptures occurred within two years of release or less, however, recaptures up to 13 years following initial release were observed. The most parsimonious model based on AIC modeled annual apparent survival as an interaction between the factors age and time (age \* time), with encounter probability being a function of an interaction between age and period (age \* period; Table 49). However, the resulting confidence interval around parameter estimates were large (e.g., ranging from 0.0-1.0 in certain years). This coupled with the relatively low difference in delta AIC of next 'best' candidate model (delta AIC = 1), led to selecting the best model as  $\Phi$  being a function of age+time, with  $p$  being a function of age group (Table 49). Using this model, trends in annual apparent survival are similar between age groups 2 and 3+, with age 1 having slightly higher annual apparent survival (possibly due to increased losses due to permanent emigration with the older age groups). For

all age groups, apparent survival trends displayed a unimodal pattern, peaking in the late 1990s through mid-2000s (Figure 123). Following this peak of approximately 0.4 (age 1) and 0.35 (ages 2 & 3+), annual apparent survival for all ages appears to be experiencing steady declines since 2010, returning to levels akin to those observed in the early 1990s by 2022 (Figure 123).

## 6.2 Stock Synthesis Models

### 6.2.1 Background

#### General Model Configuration

Population dynamics models were developed in SS version 3.30. Further descriptions of SS options, equations, and algorithms can be found in the SS user's manual (Methot et al. 2023), the SS GitHub repository (<https://github.com/nmfs-stock-synthesis/nmfs-stock-synthesis.github.io>), and Methot and Wetzel (2013). The r4ss R package (<https://r4ss.github.io/r4ss/>) was also utilized extensively to develop various graphics and summarize model outputs.

In SS, four input files are required: a starter file containing filenames and details about output reporting, a data file containing model dimensions and the data, a control file specifying model parameterization and set-up, and a forecast file containing specifications for reference points and forecasts (Methot et al. 2023). Model code is available at the SS GitHub repository.

Prior to developing the SS models in this assessment, work was done to address the simulation assessment peer review panel's recommendation to determine if the southern SS EM can produce unbiased estimates while using data without observation error (Section 1.3.2).

Briefly, during the simulation assessment review workshop time and resources were available to build a base scenario southern SS EM which continued to be configured with misspecified growth (i.e., a traditional von Bertalanffy) and a fixed natural mortality-at-age vector based on that growth, but used data without observation error. This created an improvement to the relative error, however, three-year F ratio estimates for the earlier part of the time series were very positively biased (see Figure 2 of ASMFC 2022).

At the beginning of this assessment, the impact of misspecified growth and mortality was investigated in greater detail. In the southern SS EM under the base scenario and of the 100 data iterations modeled, we identified the iteration with the lowest total log-likelihood, indicating the best model fit. Next, we took the corresponding iteration number produced by the southern SS OM, but where data was without observation error, and fit the southern SS EM to it. Improvements to the biases in relative error were seen in the three-year F ratio estimates, mature female number estimates, and the subadult number estimates (Figure 124). Since the goal of this analysis was to see if the southern SS EM could produce unbiased estimates, the EM was further configured so that growth and natural mortality matched the configuration of the OM and parameter values were fixed. As hoped, relative error was further improved as the EM was able to produce relatively unbiased estimates with no trend (Figure 124).



Following this work to confirm the southern model could produce unbiased estimates while using data without observation error, models were developed for this assessment by first using the model files from the simulation assessment while replacing simulated data with *in situ* data gathered during this assessment. These files were then modified throughout model development resulting in some differences from the simulation assessment and between stocks within this assessment. The general model configuration is described in the following section, followed by stock-specific model configuration details and data inputs.

The models were structured as length- and age-structured models that project the stock forward through time and track stock dynamics at an annual time step across length bins and age bins according to conversions from an internal growth model. Initial conditions are estimated based on (1) estimated initial F levels to reduce the unfished biomass level to that in the model start year and (2) estimated deviations to the equilibrium age structure as informed by early year class data in the start of the model.

Length bins were set at 2 cm intervals starting at 10 cm and 12 cm for the northern and southern stocks, respectively, out to the largest bin observed in each stock. All length inputs were in TL, either observed or converted using stock-specific relationships estimated with available data (Table 50). Similarly, ages were tracked starting at age-0 through the maximum age observed in each stock (62 for the northern stock, 41 for the southern stock) which acted as an accumulator age. The annual time step used was a fishing year from September of calendar year  $y$  through August of calendar year  $y+1$ . Spawning occurs in September at the beginning of the fishing year. The model does not differentiate between sexes, except in calculation of spawning stock biomass which is females only according to a 1:1 sex ratio. Modeled time series are from 1981-2022. Some 2022 fishing year data were not available or were preliminary, so this year was included in the model as an anchor for the 2021 fishing year estimates and is not used for stock status determination.

Life history parameters include age-specific  $K$  growth model parameters, Lorenzen (2005) length-based natural mortality-at-age, length-weight relationship parameters, female maturity-at-age, and stock-recruit relationship parameters (Table 51). Ages at which  $K$  was allowed to vary were specified according to the external age-specific  $K$  growth models described in Section 2.3. The Lorenzen natural mortality-at-age is calculated internally for ages 0-1 and 3-maximum age from a parameter describing natural mortality for age-2 fish. A Beverton-Holt stock-recruit relationship is used and includes parameters for unfished recruitment ( $RO$ ), steepness ( $h$ ), and variation around the expected stock-recruit relationship ( $\sigma R$ ) controlling magnitude of estimated annual recruitment deviations. Female spawning stock biomass (SSB) calculated from the maturity ogive and length-weight relationship parameters is the measure of reproductive potential used in the stock-recruit relationship.

Growth parameters (with the exception of the Length at Amin parameter in the northern stock model) and the unfished recruitment parameters for the stock-recruit relationship were estimated, while the other parameters were fixed inputs. The fixed age-2 natural mortality parameters were calculated externally using the external age-specific  $K$  growth model

estimates and the Lorenzen (2022) length-inverse model (Section 2.5). Exploration of the Lorenzen (2005) method used in SS was conducted on the southern stock model during the assessment workshops and found to produce values across ages similar to those produced by the Lorenzen (2022) model. Length-weight relationship parameters and female maturity-at-age were estimated from available data during this assessment (Section 2.4.2). Steepness of the stock-recruit relationship was fixed at 0.99 as recommended during the peer review of the simulation assessment (ASMFC 2022). This essentially reduces the stock recruit-relationship to a constant relationship between varying levels of SSB and average recruitment of the modeled time series, with annual deviations from this deterministic relationship estimated in the model. *Sigma R* is generally not estimable and was fixed based on tuning guidance from the r4ss package as recommended in the SS manual (Methot et al. 2023). Similarly, settings controlling bias adjustments to ensure mean unbiased recruitment from the lognormally distributed estimates were tuned according to recommended inputs after initial runs of the models (Methot and Taylor 2011).

Models included fishing fleets with retained catch and discarded catch, as well as surveys providing indices of abundance. Fishing fleets are defined based on sectors and fishing gears with different regulations and selectivity patterns. Each survey includes a catchability coefficient scaling its relative catch rate to the absolute abundance it is tracking. Fishery catch occurs throughout the year, while monitoring surveys sample at specified points within the year.

Selectivity of fishing fleets is modeled as length-based double normal selectivity patterns with retention curves and discard mortality specifications. The double normal selectivity pattern is a six parameter function with one parameter initializing selectivity at the starting length/age, a parameter defining the rate of ascending selectivity, a parameter defining where full selectivity peaks, a parameter defining the width of the full selectivity dome (if dome-shaped, which it is for fisheries and inshore monitoring surveys), a parameter defining the rate of descending selectivity, and a parameter defining constant selectivity of the largest sizes/ages following the descent from full selectivity. These selectivity patterns represent selectivity for total catch. Catch is partitioned into retained catch and discards according to a five parameter length-based, dome-shaped retention curve. Two retention parameters define ascending selectivity (inflection and width), one parameter defines peak values of retention between 0 and 1 (asymptote), and two parameters define descending selectivity (dome inflection, dome width). Retention is assumed to be dome-shaped due to slot limit regulations used through time. Subsequently, discards are partitioned into live discards and dead discards according to a specified discard mortality rate. Retention was allowed to change through time in a blocking pattern based on changes in regulations.

Selectivity of surveys was modeled as recruitment (special type=33) or age-0 age-based selectivity for young-of-year catches and length- or age-based double normal selectivity patterns for sub-adult catches. Length- or age-based logistic selectivity patterns were used for adult longline catches.

For fleets and surveys with estimated length-based selectivity, age-based selectivity patterns are derived from length-based selectivity and the internal growth model. Furthermore, parameters which were less informed by the data or contained excessively high variance were constrained using a symmetric beta prior to keep the parameter out of an unrealistic solution space (e.g., ascending retention inflection below 15 cm) or local minima.

Data sets fit in the models include fishing fleet catches (retained and discarded) with PSEs (recreational fleets) or assumed SEs (commercial fleets) as measures of variance, survey indices of abundance with CVs as measures of variance, and length and age compositions for the fishery catches and survey indices of abundance with effective sample sizes based on number of sampling trips observing red drum lengths or ages as measures of variance. Both marginal age compositions and conditional age-at-length data were utilized in the models. Marginal age compositions are those that describe distribution of catches/indices across ages within a year as determined according to age-length keys external to the assessment models. Conditional age-at-length data are frequencies of ages observed within length bins.

The model derived estimates included a full time series of SPR, recruitment, population abundance, and biomass (total, spawning stock, and exploitable).

#### Maximum Likelihood and Uncertainty

A maximum likelihood approach was used to evaluate the overall goodness of fit to each kind of data set. Data sets contained an assumed error distribution and an associated likelihood determined by the difference between observed and predicted values and the variance of the error distribution. The error structure for landings, discards, and indices was assumed to be log-normal. Multinomial distributions were assumed for the length and age composition data of the landings, discards, and indices, which have the variances estimated by the input effective sample sizes. The variance of the multinomial distribution is a function of true probability and sample size; thus, an increase in sample size represents lower variance and vice versa. No additional re-weighting methods on the length and age composition data (Francis 2011) were applied to base models, but rather are provided as sensitivity configurations. The total likelihood is the sum of the individual component's likelihoods. The global best fit to all the data was determined using a nonlinear iterative search algorithm to minimize the total negative log-likelihood across the multidimensional parameter space.

Several approaches were used to assess model convergence and largely follow those described in Carvalho et al. (2021). All estimated parameters were checked such that none were estimated on a bound, which may indicate potential issues with assumed model structure or data. Next, the maximum gradient component (a measure of the degree to which the model converged to a solution) was compared to the final convergence criteria of 0.0001. Ideally, the maximum gradient component will be less than the criterion, but this is not an absolute requirement. The Hessian matrix (i.e., the matrix of second derivatives of the log-likelihood concerning the parameters, from which the asymptotic standard error of the parameter estimates is derived) was confirmed to be positive definite. Following these criteria, a jitter

analysis was conducted by adjusting parameter starting values according to a jitter factor (0.1), rerunning the model, comparing the total likelihood to that of the base model, and repeating the previous steps 200 times. The jitter analysis is done to determine if the base model has converged on a local minimum solution in the likelihood surface (i.e., finds a larger negative log likelihood than any of the jitter runs) and to determine sensitivity to starting value choices.

As a diagnostic of data conflicts between the various data components that can lead to model instability, a likelihood profile was conducted for the primary population scaling parameter in the model (R0). The profile is done by fixing the parameter value, rerunning the model, examining likelihoods and repeating these steps over a range of plausible values for the parameter. A profile plot comparing change in likelihoods across the range of parameter values will ideally show a well-defined u-shape in the likelihoods with a minimum around the parameter value estimated in the base model.

Uncertainty estimates for estimated and derived quantities were calculated with the delta method after the model fitting based on the asymptotic standard errors from the covariance matrix determined by inverting the Hessian matrix (Methot and Wetzel 2013). Asymptotic standard errors provided a minimum estimate of uncertainty in parameter values.

Uncertainty is further assessed through a sensitivity analysis and retrospective analyses. Sensitivity analysis compares model estimates with key configuration or data input changes to the base model to determine sensitivity of the model to these configuration choices and data inputs. Retrospective analysis is done by sequentially dropping the final year of data from the model (a retrospective “peel”) and rerunning the model. Ideally there will be no pattern in the difference of estimates for overlapping years across retrospective peels that indicates a retrospective bias. A historical retrospective analysis was also done by comparing estimates from this current assessment with those of the previous benchmark stock assessment (ASMFC 2017) to evaluate similarities and differences between stock assessments.

While these diagnostics for model uncertainty were fully explored for the southern stock SS model, model instability precluded the use of many of these explorations for the northern stock SS model.

### Reference Point Calculations

Reference points for the models include  $F_{30\%}$ ,  $SPR_{30\%}$ , and  $SSB_{30\%}$  as thresholds and  $F_{40\%}$ ,  $SPR_{40\%}$ , and  $SSB_{40\%}$  as targets (Table 52 and Table 53). The  $F_{xx\%}$  benchmarks are in terms of age-2 fish and are the levels of fishing mortality that achieves the SPR of the same percentage. These reference points are calculated with terminal three-year averages of life history characteristics, selectivity, and fleet-specific relative fishing mortality. The  $SSB_{xx\%}$  benchmarks are the levels of SSB associated with a stock fished at the SPR of the same percentage. The SPR/F reference points are established reference points in the FMP (ASMFC 2002), while the  $SSB_{xx\%}$  reference points are new reference points in this assessment and were supported by the simulation assessment (ASMFC 2022).

## Stock-Specific Configuration Details and Data Inputs

### Northern Stock

The northern stock has three fishing fleets (Table 54) and three monitoring surveys (Table 55). Fishing fleets include a commercial fleet fishing gillnets and beach seines (North\_Commercial\_GNBS), a commercial fleet fishing other gears (mostly pound nets, North\_Commercial\_Other), and a recreational fleet (North\_Recreational) fishing hook and line gears. The monitoring surveys include a survey indexing age-0 recruitment (NC\_BagSeine), a survey indexing primarily sub-adult abundance inshore (NC\_GillNet), and a survey indexing mature abundance (NC\_Longline).

The North\_Commercial\_GNBS and North\_Recreational fleets include retained catch, discarded catch, length compositions for retained and discarded catch, and conditional age-at-length data for retained catch. Discard mortality for the North\_Commercial\_GNBS fleet was set to 1 as all discards used in the model were calculated externally as dead discards (observed dead discards plus 5% of observed discards released alive and assumed to die post release; Section 4.1.2.2). The North\_Recreational fleet discard mortality was fixed at 0.08 for all sizes, consistent with past assessments. As there are no discard estimates for either the number of fish discarded or the lengths for the North\_Commercial\_Other fleet, this fleet was modeled as a harvest-only fleet. The North\_Commercial\_Other fleet includes retained catch, length compositions, and conditional age-at-length data for retained catch. Retention parameters for the model were allowed to change based on a parsimonious approach of allowing only individual parameters expected to change given a regulation change to vary (e.g., retention inflection and width parameters following a minimum size increase). Time-varying retention parameters for the North\_Commercial\_GNBS and North\_Recreational fleets were based on changes in regulations over time, mainly in North Carolina. They were evaluated by examining changes to composition data fits during model development to structure the final retention blocks. Selectivity blocks were not used for the North\_Commercial\_Other fleet due to model instability and strange selectivity patterns where smaller fish were selected in the earliest period when there were very few regulations. The final retention and selectivity blocks are shown in Table 56.

The growth parameter for Amin in the northern model was fixed at 6 cm to anchor the growth curve as developmental model runs had the Amin parameter estimated as unrealistically high values. The age at Amin was also lowered to align with fish at this size. Symmetric beta priors were also used on the length at Amax ( $L_{inf}$ ) and  $\ln(R0)$  to keep the estimates of these parameters within a reasonable parameter space.

The initial model run presented in this report for the northern stock estimated the selectivity parameters for all three fishing fleets (hereafter referred to as the estimated selectivity model). This resulted in a narrow selectivity for the recreational fleet and low selectivity for larger sized fish that did not match an external source of selectivity information (Bacheler et al. 2010) or expectations formed by expert opinion. This model was unstable and it was difficult to get it to converge. Models often had very large maximum gradients and the Hessian was not positive definite.

An alternative model run was conducted to improve model stability by fixing the selectivity parameters for the fishing fleets based on values used from the simulation assessment (ASMFC 2022). Initial runs of this model with the selectivity fixed for all three fleets showed reasonable model fits to the length composition data for the North\_Commercial\_GNBS and North\_Recreational fleets; however, the length composition estimated for the North\_Commercial\_Other fleet did not align with the observed data, suggesting a possible misspecification from the simulation assessment. Because of this, the final alternative model fixed the selectivity parameters for the North\_Commercial\_GNBS and North\_Recreational fleets and estimated the selectivity parameters for the North\_Commercial\_Other fleet. Retention parameters were still estimated for the North\_Commercial\_GNBS and North\_Recreational fleets in these models.

The method used to estimate fishing mortality in the models was the hybrid approach (SS F method 3). This method uses a Pope's approximation to estimate the initial values of F and then iteratively adjusts the Baranov continuous F values to closely match the observed catch. F method 4, which is a new fleet-specific parameter hybrid approach with fleet-specific annual fishing mortality estimated as parameters, was also explored during model development due to recommendations of estimating fishing mortality parameters when there is uncertainty around annual input catch values and in situations when fishing mortality is expected to be high (Methot et al. 2023). Model fits, however, did not change and many of the annual F estimates were estimated at the lower and upper bounds, and there was a desire to keep the model simple and minimize the number of parameters being estimated due to model stability. For these reasons, the two models presented here used F method 3 rather than 4. Symmetric beta priors were used on the initial F estimates for the three fishing fleets to keep the estimates away from the lower bound of 0.

Monitoring surveys included indices of abundance, length compositions for the inshore, sub-adult survey, and conditional age-at-length data for both the inshore, sub-adult survey and offshore, adult longline survey. Length compositions were not included for the offshore, adult longline survey due to early model runs which suggested there may have been data conflicts between the length and conditional age-at-length composition data.

Data time series are shown in Figure 125.

### Southern Stock

The southern stock has three fishing fleets (Table 57) and seven monitoring surveys (Table 58). Fishing fleets include recreational fleets fishing hook and line gears for each of the three states in the southern stock. Historically, commercial red drum fishing did occur in these states, but most of this fishing was eliminated by the late 1980s. The only non-negligible commercial catch came from Florida in the early 1980s (Section 4.1.1.1; Table 23). Commercial selectivity was assumed to have been similar to recreational selectivity and, therefore, any commercial catch was interpreted as part of the recreational fleet when it did occur in the earlier years (i.e., combined with the recreational catch). The monitoring surveys include three surveys indexing

age-0 recruitment, three surveys indexing primarily sub-adult abundance inshore, and one survey indexing mature abundance.

Fishing fleets include retained catch, discarded catch, length compositions for retained and discarded (except SC) catch, and conditional age-at-length data for retained catch. Discard mortality for these recreational fleets was fixed at 0.08 for all sizes, consistent with past assessments. Retention parameters were allowed to change based on a parsimonious approach of allowing only individual parameters expected to change given a regulation change to vary (e.g., retention inflection and width parameters following a minimum size increase). Time-varying retention parameters were evaluated by comparing model likelihoods and examining changes to composition data fits during model development to structure the final retention blocks. The final blocks are shown in Table 59.

The fishing fleet selectivity parameters defining the width of the full selectivity dome were poorly or not informed by available data, were not well estimated, and resulted in narrow domes that did not match external sources of selectivity information (Bacheler et al. 2010; Troha 2023) or expectations formed by expert opinion. Further, the parameters defining the size at which full selectivity first peaks were well estimated, anchoring the beginning of the full selectivity dome. Therefore, the width parameters were fixed so that descending selectivity would start at  $\approx 75$ cm given peak parameters estimating full selectivity starting at  $\approx 40$  cm. This fixed value was based on the mid-point of the largest size bin (70-79 cm) estimated by Troha (2023) to have full selectivity in the SC\_Trammel survey. This survey uses a gear that selects all sizes encountered by the recreational fishery and operates at similar times and in similar areas as the recreational fishery.

Due to the lack of length composition data for the SC\_Recreational fleet to inform selectivity of the largest sized red drum encountered by the trophy adult catch and release fishery, an informative normal prior was also included in the model for the parameter defining selectivity of these sized fish. The prior mean and standard deviation were set based on the Troha (2023) estimate for recreational release selectivity of the largest regularly encountered size bin in the data set used in this study (90-99 cm). There are intermittent catches of larger sizes, but these fish were not encountered consistently through periods evaluated in the study.

The method used to estimate fishing mortality in the model was the new fleet-specific parameter hybrid approach (SS F method 4), with fleet-specific annual fishing mortality estimated as parameters. This method was explored during model development due to recommendations of estimating fishing mortality parameters when there is uncertainty around annual input catch values and in situations when fishing mortality is expected to be high (Methot et al. 2023). Model fits, particularly to discard data, improved with this method and it was adopted in the base model.

Monitoring surveys included indices of abundance, length compositions, marginal age compositions (inshore, sub-adult surveys), and conditional age-at-length data (offshore, adult longline survey).

During model development, data conflicts contributing to model instability were identified between longline survey data sets capturing information on the mature, adult population and data sources including information primarily on the sub-adult components of the stock (inshore surveys, fishing fleet catches). Longline survey index trends conflicted with other data sets, including (1) the SC\_Longline\_historic survey index showing a relatively flat trend and little change in population biomass despite sub-adult data sets indicating large changes in biomass during earlier years and (2) the GA\_Longline survey index showing a generally increasing trend which conflicted with the SC\_Longline\_contemporary survey index of the same time period and sub-adult data sets indicating declining trends in biomass during earlier years. Given these conflicts, only the contemporary SC\_Longline\_contemporary survey was retained in the model.

Additionally, the SC\_Longline\_contemporary survey composition data showed decreasing mean size and age trends that the model did not expect given decreasing biomass driven by reduced recruitment to the adult population. To address this conflict, the model estimated selectivity patterns that pushed selectivity to the largest sizes/ages without ever reaching full selectivity. Therefore, the length composition data for this survey was excluded from the model and the length-based selectivity was fixed based on estimates from Troha (2023). The conditional age-at-length data were retained, but with a non-defined age selectivity pattern so these data could inform growth of the larger sized fish and early recruitment deviations used to define the initial population structure.

Data from an additional inshore monitoring survey, the SC\_Electro survey, not included in the models during the simulation assessment was included in some early model development. However, inclusion of the survey data resulted in deteriorating model stability with several model parameters moving to bounds and nonsensical population estimates (biomass and SPR estimates at zero in all years), so the survey was not included in the final model.

Data time series are shown in Figure 126. Note that some of these surveys have been discontinued.

## 6.2.2 Results

### Northern Stock

The estimated selectivity model had a maximum gradient component of 0.00425 with a Hessian matrix that was positive definite. There were 62 estimated parameters and 54 estimated deviations (Table 60 - Table 62). Thirteen parameters were estimated at or within 1% of their bounds, no parameter pairs were highly correlated ( $> \pm 0.95$ ), and nine parameters had low correlations ( $< 0.01$ ) with all other parameters.

Attempts to adjust bounds on the estimated selectivity model often resulted in the model not converging (e.g., resulted in large gradients and a Hessian that was not positive definite). In order to see if a better set of starting values could be found, a jitter analysis of fifty runs was conducted using a jitter factor of 0.25. Nineteen runs in the jitter analysis estimated a solution with a negative log-likelihood identical to the base estimated selectivity model and six runs estimated a solution with a slightly smaller negative log-likelihood (Table 63). The remaining



twenty-five runs had larger negative log-likelihoods and did not converge. The results of the runs with the smaller negative loglikelihood were very similar to those from the initial estimated selectivity model. The main difference was the estimated retention curve for the first retention block of the North\_Commercial\_GNBS fleet. The retention curve from the lower log-likelihood model was much narrower in the first regulatory block than the initial model. This result was counterintuitive given the fewer size regulations in place at that time. Given the wider North\_Commercial\_GNBS fleet retention curve and that most of the converged model runs converged on the initial estimated selectivity model solution, the results from this model are presented.

Fits to the catch data were very tight as expected with F method 3 (Figure 127-Figure 129). The model fits to the North\_Commercial\_GNBS and North\_Recreational discards showed patterning, especially after 1990 (Figure 130 and Figure 131). While the estimated discards fit well for the North\_Commercial\_GNBS fleet in the 1980s, the model tended to overestimate the number of discards for this commercial fleet starting in the 1990s and diverged more by the late 1990s and early 2000s. In contrast, the number of recreational discards tended to be slightly overestimated in the 1980s by the model and were underestimated starting in the late 1990s and early 2000s.

Fits to survey indices of abundance varied depending on the index (Figure 132 - Figure 134). The model generally fit the NC\_BagSeine survey well in the later part of the time series though the model tended to overestimate the large 2011-year class. However, the model tended to underestimate the index early in the time series, resulting in some residual patterning and not fitting well to the peaks in abundance observed in the early 1990s. The fit to the NC\_GillNet survey was generally good and the residuals did not show any concerning patterning. The model had trouble fitting the greater observed interannual variability for the NC\_Longline survey due to the survey covering such a large number of year classes. Because of this, the model estimates a decreasing trend through the index.

The model generally fits length compositions well across the time series (Figure 135), with some slight difficulties estimating the bimodal patterns observed in the length frequencies for most of the fleets between 30-75 cm. This lack of fit is seen for annual data sets as well (Figure 136 - Figure 140).

Fits to the conditional age-at-length were generally good though the model tended to underestimate the mean ages early in the time series for all three of the harvest fleets. While the model slightly underestimated the mean age of fish from the North\_Commercial\_GNBS fleet early in the time series, it generally fit well starting in 1995 (Figure 141). A similar pattern was observed in the mean age data for the North\_Commercial\_Other fleet (Figure 142) and the North\_Recreational fleet (Figure 143) where the mean age is underestimated early in the timeseries and begins to match better starting around 2000. Fit to the conditional age-at-length data for the NC\_GillNet survey showed a bias with the model tending to overestimate the mean age through time (Figure 144). Fits to conditional age-at-length data for the NC\_Longline survey

tended to be better other than a period from 2014-2019 where the mean age tended to be overestimated by the model (Figure 145).

Length-based selectivity estimates for the commercial and recreational fishing fleets all had dome-shaped selectivity patterns that ascend and descend sharply but the widths varied (Figure 146). The widest selectivity was estimated for the North\_Commercial\_GNBS fleet. The North\_Commercial\_Other fleet had a narrow selectivity that was shifted to the right of the other curves due to the lack of discard information available for this fleet. The North\_Recreational fleet selectivity was also narrow and did not select for any larger fish, contrary to expert knowledge of the fishery. The North\_Recreational selectivity was similar to that estimated for the NC\_GillNet survey. The age-based selectivity pattern of the NC\_Longline survey shows recruitment to the mature, adult stock around age 5 with an estimated age of inflection at age 19.5 (Figure 147). Derived age-based selectivities for the harvest fleets and the gill net survey show selectivity focused on ages 1-3 with very sharp selectivity peaks. Retention estimates generally show narrowing domes through time as regulations become more restrictive for the North\_Commercial\_GNBS and North\_Recreational fleets (Figure 148 and Figure 149). While a model was attempted that included selectivity blocks for the North\_Commercial\_Other fleet, the resulting estimates for the second selectivity block just shifted the entire curve to the right suggesting harvest of even larger fish as regulations began to tighten in the early 1990s. Given this model behavior, as well as continued issues with model stability, this fleet was simplified and the blocks were not added.

Recruitment deviations show random variation around time series average recruitment levels during the modeled years (i.e., Beverton-Holt stock-recruit relationship with steepness fixed to 0.99; Figure 150). This resulted in generally flat levels of recruitment other than the large 2011-year class (Table 64, Figure 151). However, the model estimated very large, positive deviations in the 1970s. While the age data from the longline survey supports these large year classes in 1973 and 1978, the deviations were concerning as they were above the large year-class in 2011 which seemed unlikely.

These large year classes in the 1970s that the model estimated were not available to the fishery (based on the estimated selectivity curves) and resulted in the model estimating an overall downward sloping population trend that appeared to show just the effects of natural mortality through time (Table 64, Figure 152). In the estimated selectivity model, the overall population numbers decreased through time and began to flatten out around the late 2000s. It is after this point that the population begins to show peaks due to larger year classes entering the population. SSB shows this same trend (Table 65, Figure 153).

The model, even using symmetric beta priors to keep the initial fishing mortality estimates away from the lower bound, consistently wanted low initial  $F_s$  for all three fishing fleets. This results in a general trend of increasing fishing mortality on age-2 fish through time with the highest levels of  $F$  in recent years (Table 66, Figure 154). This trend in  $F$  resulted in the estimated selectivity model having very high SPRs early in the time series when it is thought the stock size was low and SPRs decreasing towards the threshold in recent years (Table 66, Figure

155). Despite the decreasing SPRs through time, the SPRs remained above the threshold except for the final year of the time series. The terminal three-year average SPR was estimated at 0.603 (Table 66).

The historical retrospective analysis for the northern stock shows divergent SPRs between the previous statistical catch-at-age model and the new SS model in the beginning of the time series and the scale of the SPR estimates from the two models converge around 2010 (Figure 156). While the scales are different early in the time series, both models show a generally increasing SPR in the early 1990s which begins to decrease in the mid- to late-2000s.

There were multiple concerns with the estimated selectivity model. While model stability was a large one, there were also concerns about the high recruitment deviations estimated in the 1970s which drove a lot of the population trends observed. Additionally, the recreational fleet selectivity pattern did not match expert opinion with the narrow estimated selectivity and lack of selectivity on larger fish when it is known that a fishery exists for large bull red drum. Lastly, the low initial  $F_s$  and trends in stock biomass did not align with expectations of the history of the fishery through time.

In an effort to improve model stability, a second model was run where the North\_Commercial\_GNBS and North\_Recreational selectivities were fixed based on parameters used in the simulation assessment (ASMFC 2022). The retentions for these fleets across the three regulatory periods were still estimated. The North\_Commercial\_Other fleet selectivity was also initially fixed based on parameters used in the simulation assessment but fits to the observed length composition data were poor indicating a possible misspecification in the simulation assessment. Because of this, the selectivity was estimated for the North\_Commercial\_Other fleet and as before, was estimated without selectivity blocks. This model, with selectivity fixed for two of the harvest fleets and estimated for one, is referred to as the hybrid selectivity model in this report.

The hybrid selectivity model had a maximum gradient component of 0.01789 with a Hessian matrix that was positive definite. There were 54 estimated parameters and 54 estimated deviations. No parameters were estimated at or within 1% of their bounds, no parameter pairs were highly correlated ( $> \pm 0.95$ ), and three parameters had low correlations ( $< 0.01$ ) with all other parameters. Compared to the estimated selectivity model, the  $\ln(R_0)$  parameter was estimated lower for the hybrid selectivity model (6.69 vs. 7.91) resulting in a lower stock size overall.

Fits to the catch data in the hybrid selectivity model were very similar to those estimated by the estimated selectivity model (Figure 127 - Figure 129). The model fits to the North\_Commercial\_GNBS and North\_Recreational discards again showed patterning as was seen in the estimated selectivity model (Figure 130 and Figure 131). While the North\_Commercial\_GNBS discards continued to be overestimated by the model, especially after the late 1990s, and the North\_Recreational discards continued to be underestimated in the same time period, the use of the fixed selectivities caused these patterns to become more pronounced.

Fits to survey indices of abundance again varied depending on the index (Figure 132 - Figure 134). The fit to the NC\_BagSeine survey under the hybrid selectivity model slightly underestimated the survey in the early part of the time series and overestimated the survey in the later part of the time series compared to the estimated selectivity model. Similarly, the fit to the NC\_GillNet survey index using the hybrid selectivity model resulted in the survey being underestimated in the early part of the time series and overestimated in the later part of the time series compared to the estimated selectivity model. It seemed that the hybrid selectivity model was less influenced by the 2004 and 2005 gill net index points than the estimated selectivity model. As before, the hybrid model also estimated a decreasing trend through the NC\_Longline index and did not fit the observed interannual variability well.

Despite the hybrid selectivity model having the selectivities fixed for the North\_Commercial\_GNBS and North\_Recreational fleets, the model generally fit the length compositions well across the time series (Figure 135). While the second peak for the North\_Commercial\_GNBS discards isn't fit as well using the hybrid selectivity model, and neither is the largest peak in the recreational discards, the fits in general to the length compositions did not change that much from the estimated selectivity model.

Fits to the conditional age-at-length also did not seem to change much with the hybrid selectivity model. The North\_Commercial\_GNBS fleet mean age was fit a little better early in the time series when compared to the estimated selectivity model (Figure 141); however, the fits to the conditional age-at-length data for the North\_Commercial\_Other and North\_Recreational data were very similar between the models (Figure 142 and Figure 143). Fits to conditional age-at-length data for the NC\_GillNet survey continued to not fit as well with the model again tending to overestimate the mean age through time (Figure 144). Fits to conditional age-at-length data for the NC\_Longline survey continued to fit well and the period from 2014-2019 no longer was consistently overestimated (Figure 145).

Length-based selectivity estimates for the commercial and recreational fishing fleets under the hybrid model again all had dome-shaped selectivity patterns that ascend and descend sharply and the North\_Commercial\_GNBS and North\_Recreational selectivities were fixed (Figure 146). The fixed selectivity of the North\_Commercial\_GNBS was very similar to that estimated in the estimated selectivity model. The North\_Recreational selectivity was fixed to be much wider than that estimated by the estimated selectivity model and had a selectivity of around 0.2 for larger fish. The North\_Commercial\_Other selectivity was estimated as a narrow selectivity curve, similar to that estimated in the estimated selectivity model. After fixing the selectivities of those two fleets, the NC\_GillNet selectivity estimated by the hybrid selectivity model was much wider than that estimated by the estimated selectivity model. The age-based selectivity pattern of the NC\_Longline survey was very similar between the two models though the estimated age of inflection was slightly larger (20.7) and the curve had a slightly narrower width estimated (Figure 147). Derived age-based selectivities for the harvest fleets and the gill net survey still select mostly ages 1-3 fish but the recreational age-based selectivity was slightly broader than that estimated by the estimated selectivity model. Retention estimates for the North\_Commercial\_GNBS fleet were estimated to be much broader using the hybrid selectivity

model though it still showed a narrowing of the retention curves through time as regulations tightened (Figure 148). The retention estimates for the North\_Recreational fleet showed a more gradual change in the retention curves across the regulatory blocks than was observed in the estimated selectivity model which seemed to shift up and down slightly between periods (Figure 149).

Recruitment deviations in the 1970s for the hybrid selectivity model were more in line with the large 2011 year-class and seemed more reasonable in scale (Figure 150). As before, the recruitment deviations between 1981 and 2021 were fairly flat and generally varied without trend around the mean. This resulted in generally flat levels of recruitment other than the large 2011 year-class (Figure 151). Additionally, the scale of the recruitment estimates were quite different between the estimated and hybrid selectivity models with the hybrid selectivity recruitment estimated to be much smaller.

With the reduced scale of the population, the total population numbers no longer showed a decreasing trend over time as seen with the estimated selectivity model (Figure 152). Overall population numbers decrease through the 1980s before increasing again slightly in the mid-1990s. The population numbers estimated by the hybrid selectivity model begin to bounce around more starting in 2010 through the end of the time series. SSB estimated by the hybrid selectivity model still showed a downward sloping trend through time, though again the scale was much lower than what was estimated by the estimated selectivity model (Figure 153).

The hybrid selectivity model, again using symmetric beta priors to keep the initial fishing mortality estimates away from the lower bound, still consistently wanted low initial  $F_s$  for all three fishing fleets. This again resulted in a general trend of increasing fishing mortality on age-2 fish through time with the highest levels in recent years (Figure 154). However, compared to the estimated selectivity model, the  $F_s$  were scaled much higher. This resulted in the hybrid selectivity model having estimated larger SPRs ( $\sim 0.6$ ) early in the time series and the stock being fished down to very low SPRs quickly (Figure 155). SPRs remained below the threshold for all years of the time series beginning in 1984. The terminal three-year average SPR was estimated at 0.068.

While there were differences in model fits between the hybrid and estimated selectivity models which resulted in very different model scales, the model trends in  $F$  and SPR were very similar when plotted standardized to their means (Figure 157). This suggests that the models are each picking up the same trend of an increasing  $F$  through time even if the scale of the overall population is uncertain.

### **Southern Stock**

The base model had a maximum gradient component of  $5.76014e-05$  with a Hessian matrix that was positive definite. There were 201 estimated parameters and 54 estimated deviations (Table 67 - Table 70). No parameters were estimated at their bounds, no parameter pairs were highly correlated ( $> \pm 0.95$ ), and no parameters had low correlations ( $< 0.01$ ) with all other parameters.

One hundred and ninety-two of the two hundred runs in a jitter analysis estimated a solution with a negative likelihood identical to the base model (Table 71). Three runs converged on solutions with larger negative loglikelihoods than the base model and five runs did not converge. These results provide no evidence that the model has converged on a local minimum in the likelihood surface and indicate the base model is fairly insensitive to starting parameter value choices.

Fits to catch data show some divergence, particularly for the FL\_Recreational fleet, during a few years in the early 1980s and again in the mid-2010s (Figure 158). The misfit in the 1980s was reduced with changes to the retention parameterizations, but the misfit in the mid-2010s could not be resolved. The model fits fishery discards well (Figure 159).

Fits to survey indices of abundance show no concerning residual patterns indicative of major model misspecification (Figure 160 - Figure 162). Fits to indices from inshore surveys in the early 1990s indicate some balancing of data conflicts with the SC\_Trammel survey index showing a strongly declining trend while the SC\_StopNet survey index shows a flatter period of abundance at the end of its short time series. The model has trouble fitting the greater observed interannual variability of a few years around 2010 for the SC\_Longline\_contemporary survey than is expected for a survey covering such a large range of year classes.

The model generally fits length compositions well across the time series (Figure 163), with some slight difficulties capturing sharp multimodal patterns of the fast-growing sub-adults and some of the limited, noisier data sets (i.e., recreational discards). This lack of fit is seen for annual data sets as well (Figure 164 - Figure 171).

Fits to age compositions capture the sharp domes of ages available to the inshore surveys (Figure 172). There is some residual patterning through time, particularly around the mid-2010s, for older ages captured by the SC\_Trammel survey, with the model expecting fewer of these older fish being captured by the survey, and through the 2000s for age-0 fish captured by the FL\_183\_HaulSeine survey, with the model expecting more age-0 fish than observed (Figure 173). Fits to conditional age-at-length data capture the trends in age structure for the recreational fleets, though there is some lack of fit to the earliest years of data from the SC\_Recreational fleet and a period of years from the late 2000s through the early 2010s from the GA\_Recreational fleet (Figure 174). It was unclear why the age structure of samples collected in Georgia shifted to older ages in these years before shifting down to a younger and more stable age composition in later years as there were no regulation changes that would explain this shift. Fits to conditional age-at-length data for the SC\_Longline\_contemporary survey show some patterning with poorer fits in early years and good fits in recent years (Figure 175). This appears to be a data conflict with the model expecting less of a decline in the age structure captured by this survey than observed given the declining recruitment to the adult population indicated by sub-adult data sets. Similar trends were observed in fits to the length data for this survey leading to its exclusion from the model, but the conditional age-at-length data were retained in the model despite the misfit to provide information on adult growth and early recruitment deviations prior to the start of the model time series.

Length-based selectivity estimates for the recreational fishing fleets show similar broad dome-shaped selectivity patterns that ascend and descend sharply as red drum grow rapidly to exploitable sizes and then emigrate from inshore habitats, respectively (Figure 176). The fixed selectivity pattern of the SC\_Longline\_contemporary survey shows recruitment to the mature, adult stock at sizes starting around the size recreational selectivity has descended to lower constant values representative of the adult catch and release fishery. The SC\_Recreational fleet has the highest selectivity of mature adults, followed by the GA\_Recreational fleet and then the FL\_Recreational fleet. Retention estimates show narrowing domes through time as regulations become more restrictive (Figure 177). Estimated selectivity patterns for inshore monitoring surveys show strongly dome-shaped patterns covering the first few age classes (Figure 178). The SC\_Trammel survey selects the broadest age range of the inshore surveys.

Recruitment deviations show random variation around time series average recruitment levels (i.e., Beverton-Holt stock-recruit relationship with steepness fixed to 0.99; Figure 179). However, positive deviations in the 2010s were generally smaller than those in earlier decades indicating reduced recruitment in recent years (Table 72, Figure 180). There was a large year class predicted in the 2022 fishing year (the largest of the time series) that had yet to recruit to the fisheries, as indicated by several of the indices of abundance. Additionally, there were several relatively large negative deviations around the model start year indicating a depleted exploitable population in the early 1980s.

Overall population numbers show increases through the 1980s and early 1990s, variable but higher levels through the late 1990s and 2000s, followed by a decline since 2010 (Table 72, Figure 181). Pulses of abundance increase are notable in the early 1990s, early 2000s, and late 2000s. SSB increases from low levels in the 1980s and peaks in the late 2000s then declines through the remainder of the time series (Table 73, Figure 182). Relative to the SSB produced from fishing the stock at 30% SPR, the SSB was well below this threshold at the start of the time series, first exceeded this threshold in 1993 and remained above this threshold through 2018, and has continued a declining trend below this threshold since 2019 (Table 73, Figure 183). The terminal three-year average (2019-2021) relative biomass is 0.881, indicating the stock is overfished (Table 73). The upper limit of the 95% confidence intervals based on asymptotic standard errors for annual relative spawning stock biomass estimates making up the terminal three-year average are at the threshold (1.0 in 2021) or slightly above the threshold (1.2 in 2019 and 1.1 in 2020).

Florida has accounted for the majority of catch from the stock and exhibited the highest fishing mortality levels of the three fishing fleets, followed by South Carolina and then Georgia (Table 69, Figure 184). All fleets have increasing fishing mortality since the 2000s that peaks at or above levels in the early 1980s near the terminal year of the assessment. There is variability in the terminal year, but levels for all fleets remain high. There was a brief period of high fishing mortality, primary in Florida, in the early 1980s before Florida implemented several years of highly restrictive regulations including a moratorium. Overall, fishing mortality on age-2 fish was at its highest levels in the early to mid-1980s, decreased sharply in the late 1980s, and has followed an increasing trend through the late 2010s with an increased rate since the early

2010s (Table 74, Figure 185). Fishing mortality declined slightly in the last few years of the assessment but remains at high levels. In terms of SPR, high fishing mortality led to SPRs below the management threshold of 30% in the early 1980s. SPR then increased above the threshold (and target of 40%) in the late 1980s, followed by a declining trend that falls below the threshold again in 2013 (Table 74, Figure 186). SPRs remain below the threshold for the remainder of the time series. The terminal three-year average SPR is 0.207, indicating overfishing is occurring (Table 74). The upper limit of the 95% confidence intervals based on asymptotic standard errors for annual SPR estimates making up the terminal three-year average are below the threshold in two years (0.25 in 2019 and 0.28 in 2021) and above the threshold in 2020 (0.35).

A likelihood profile for the  $R_0$  parameter across a range of 8 to 10.5 with increments of 0.1 shows length data, discard data, and recruitment deviations all support a similar likelihood surface as the total likelihood with minima near that of the total likelihood (Figure 187). Some conflict among data sets is apparent with age data supporting a smaller  $R_0$ , while index data support a slightly larger  $R_0$ . Catch data are informative of the lower bound of the  $R_0$  parameter, but less informative of the upper bound. The total likelihood is the balance of these information sources and shows a well-defined total likelihood surface with a minimum at the base model estimate of 8.67.

A retrospective analysis with a six-year peel shows some retrospective bias in the model. The model has a tendency to underestimate SSB (Figure 188) and overestimate fishing mortality (Figure 189). The three-year peel (terminal year of 2019) diverges from the pattern of other peels and leads to a more severe retrospective bias. This divergence is due to the model having more flexibility to fit to decreased index values observed across several indices in the terminal year of this peel (Figure 191). In other peels, data before and after this year preclude the model fitting as closely to these index data points. With all peels, the Mohn's rhos, a measure of the retrospective bias, are just outside the rule of thumb range proposed by Hurtado-Ferro et al. (2015) for determining no retrospective pattern in an assessment of a long-lived species (-0.15-0.20; Figure 188 and Figure 189). With the three-year peel excluded from calculations, Mohn's rhos are within this range.

The SAS decided not to make retrospective bias adjustments to base model estimates for three reasons. First, the retrospective pattern is the less concerning directionality from a precautionary perspective (underestimating SSB, overestimating F). Second, the magnitude of Mohn's rhos are driven to larger values by the single divergent three-year peel. Finally, the adjustments using the Mohn's rho values would not change the stock status point estimates in the assessment terminal year.

The historical retrospective analysis shows very similar SPR estimates in the first four years that overlap between assessments (1989-1992; Figure 190). The SS model in the current assessment then estimates more of a decline for the remainder of the overlapping time series than the statistical catch-at-age model used in the previous assessment. Both assessments estimated a decline in the terminal year of the previous assessment (2013), but the SS model estimates a



greater magnitude in this decline. The wide confidence intervals from the last assessment generally include the point estimates and their confidence intervals from the current assessment and demonstrate one of the primary deficiencies of the previous assessment.

Nine sensitivity configurations are presented here (run names bolded and italicized) to demonstrate the impact of key model assumptions and data choices. A configuration with composition data set variances re-weighted according to the Francis (2011) iterative reweighting methods (*Reweight*) was compared to determine sensitivity to data weighting choices. A configuration with the start year advanced to 1989 (*1989*) was compared as this was the start year used in models in previous benchmark assessments and the simulation assessment due to reduced data quantity in earlier years. One advantage of SS is its ability to handle years with varying quantities of data and the early 1980s data available (catch) show contrast during years before most management went into place, so 1981 was adopted as the start year for the base model. A configuration with a reduced discard mortality rate assumption (4%, *4% discard*) was compared due to uncertainty around this value stemming from earlier assessments. The sensitivity value represents a 50% reduction to the base value (8%) and was the value suggested by reviewers of the simulation assessment. Two alternative data sets were used in sensitivity configurations dealing with uncertainty in MRIP catch estimates. The first included imputed wave 1 catch estimates for states that do not have consistent estimates for this wave (Georgia and South Carolina, see Section 4.2.1; *Wave 1*). The second included MRIP catch data sets (retained and discarded catch) reduced by 30% (*70% catch*) as a proxy for potential effects from pending re-estimation of effort data (see Section 4.2.1). The proxy data sets assume a linear relationship between catch and effort using the preliminary central tendency for effort reductions expected by MRIP staff (John Foster, NOAA, personal communication). Two alternative natural mortality values were evaluated as a standard source of uncertainty in stock assessment. The first configuration included the base model age-2 value decreased by 20% (*M -20%*) and the second configuration included the base model value increased by 20% (*M +20%*). As with the base model, natural mortality values for other ages are then calculated internally in SS with the Lorenzen (2005) method and model-estimated growth. The final set of sensitivity configurations were included to evaluate uncertainty from the fixed selectivity parameters used in recreational fleets. The parameters were changed in the first configuration so that descending selectivity would start at  $\approx 65$ cm given peak selectivity parameter estimates at  $\approx 40$  cm (*Descend 65*). The second configuration included fixed values with descending selectivity starting at 85cm given peak selectivity parameter estimates at  $\approx 40$  cm (*Descend 85*). These two alternatives represent mid-points of the two bins adjacent to that estimated to have full selectivity for the SC\_Trammel survey by Troha (2023) and covers the range the SAS believes is most likely to be where descending selectivity of the recreational fisheries starts. An additional configuration with steepness estimated was explored based on the recommendation in the simulation assessment, but the model estimated steepness at the upper bound of 0.99 which is the fixed value used in the base model. This indicates there is not enough information in the data to estimate steepness and returns identical results to the base model.

All sensitivity configurations estimate trends similar to the base model but show some uncertainty in scale. The most notable difference in scale comes from the *Descend 85* configuration. The stock is estimated to have experienced higher fishing mortality through time with the broader full selectivity dome (Figure 192), leading to lower SPRs that don't allow the stock to rebuild as estimated in the base model (Figure 193). The other notable divergence is the *1989* configuration. This model estimates a less depleted stock in 1989 than the base model (and all other sensitivity configurations) that declines at about the same rate as the base model since the late 2000s, but ends up just above the SSB threshold in the terminal year. This is the only configuration with a different terminal year SSB status than the base model. As with the base model, SPRs in the *1989* configuration fall below the threshold in 2013 and remain below the threshold consistently with the exception of 2020. The terminal three-year average SPR is below the threshold, consistent with all other runs. These results show there was additional information content in the pre-1989 data unavailable to the *1989* configuration that indicated a more depleted stock in 1989 (and all other years).

The model was consistently insensitive to data weighting throughout model development as is the case in this sensitivity analysis, therefore empirical weighting was used in the base model. The *70% catch* configuration primarily had a scaling effect on population biomass and abundance (Figure 193), but little effect on the relative SSB and F/SPRs. This is a good indication of effects if MRIP effort re-estimation leads to a consistent scaling effect to catch through time, but should be revisited if the effect is time-varying. Aside from the *1989* and *Descend 85* configurations, the model estimates of when the stock SSB was rebuilt is sensitive to configuration choices, ranging from 1990 in the *M +20%* configuration to 1997 in the *M -20%* configuration. However, the model is largely insensitive to configuration choices for terminal year SSB status with all these configurations converging to very similar levels.

## 6.3 Traffic Light Analysis

### 6.3.1 Background

The TLA was first developed (Caddy 1998; Caddy 1999; Caddy et al. 2005; Caddy and Mahon 1995) for application in data-limited fisheries and can provide an information basis for fish stock management decisions that is not constrained by a model-based framework.

The TLA uses colors like that of a traffic light to represent the state of a fishery based on appropriate indicators (i.e., an index or time-series of relevant data). Indicators are used to compare recent years of data with previous years to detect trends. The type of indicators may vary and can be based on population and/or fishery dynamics such as abundance, growth, reproduction, removals, or other metrics that are appropriate to the available data. These indicators may be derived from various fishery-independent or fishery-dependent sources (e.g., survey derived indices, harvest/landings time series) and can be representative of various phases in the life cycle (e.g., juvenile, sub-adult, adult). The temporal extent of appropriate indicators should span multiple generations to be representative of population trends.

One common method called the strict traffic light method uses hard boundaries based on reference points to assign a color and uses a binary logic model. Another method called the fuzzy traffic light method uses a fuzzy logic model where the transitional color (yellow) is based on the proportion of adjacent color the indicator is trending towards (e.g., yellow/red or yellow/green; Figure 194).

Reference points are identified as either threshold reference points or target reference points. A threshold reference point (the focus of this assessment, referred to hereafter as “threshold”) might be thought of as unacceptable outcomes such as an indicator value moving from yellow to red whereas target reference points are desirable outcomes where a stock status objective has been achieved such as a target SPR or SSB. Setting reference points requires identifying appropriate metrics to indicate when stock status moves from fully acceptable to unacceptable with a buffer zone between the two to provide warning of proximity to unacceptable conditions.

The TLA framework used in the assessment was previously developed for the simulation assessment (ASMFC 2022). Results of the simulation assessment suggested the TLA was useful as a potential assessment methodology for red drum, although there was some variability in the effectiveness based on stocks. The TLA was also observed to outperform the age-structured models in characterizing recruitment condition. Overall, the TLA showed utility as a supplementary assessment approach for development of fishing mortality status, SSB status, and recruitment condition determinations. The TLA can be updated relatively easily, potentially allowing for interim analysis between formal assessments to update stock status for management advice.

The objective here was to use the TLA framework to evaluate the status of the red drum populations in the northern and southern stocks.

### **6.3.2 Framework and Optimization**

A custom TLA framework was developed using R (code available upon request). The fuzzy method was applied to each indicator by calculating the relative proportions of each color for each year based on the trends from a selected reference period in the time-series that was considered representative of previous trends. This was accomplished by setting the expected value of an indicator to a relative proportion of 1 for yellow and 0 for red and green (Figure 194). The intersection of the color lines at 0.5 relative proportion corresponds to the 95% confidence intervals derived from the reference period values. The relative proportion of 1 for red and green and 0 for yellow were set to 2 times the confidence intervals. Corresponding linear regression equations were calculated to determine the slope and intercept coefficients which were used to determine a proportion of red, yellow, and green for each value of an index.

The resulting color proportions were then compared to a selected threshold and any value with a proportion red above the threshold would potentially trigger a management action, which can be based on a conditional rule such as a selected number of consecutive years above the

threshold. It was important to select an appropriate number of consecutive years above the threshold for the initiation of management action as a short time frame may be too sensitive to annual variability (stochasticity) in indicator values and can be mistaken for changes in fishing pressure. Conversely, a time frame requirement of too many consecutive years above the threshold may result in slow responsiveness to significant changes in fishing pressure.

Potential characteristics for the TLA (ASMFC 2022) were evaluated during the simulation assessment, with six being chosen based on available data from the stocks. Based on the results of that effort and further evaluation of the data these characteristics were reduced to three key characteristics: recruitment, adult abundance, and fishery performance (Table 75). Multiple indicators of the same characteristic were combined into composite “characteristics” designed to collectively represent a characteristic of interest for management (e.g., abundance, production, recruitment, fishery performance). These indicators are additive and the resulting combined index was rescaled from 0 to 1 (ASMFC 2020; Halliday et al. 2001).

It may be inappropriate to select a long time series for the reference period since long-term averages can be affected by regime shifts in stock productivity and/or fishing pressure. Therefore, the reference period was selected for the northern red drum stock as 1996–2013 and for the southern stock as 1991–2013 when these stocks were not experiencing overfishing based on the previous stock assessment results and based on when index data time series begin in each stock. The expected value was calculated as the geometric mean of the indicator values during the reference period and the confidence intervals were based on the expected value and standard deviation from the indicator values during the reference period. Model sensitivity to the reference period was evaluated by varying the duration and initial and terminal years of the reference period timeframe using 3-year increments.

Abundance indicators were developed from fishery-independent survey relative indices of abundance indexing various components of the stock abundance (Table 76). Fishery performance was defined as the relative harvest fishing mortality which was calculated by dividing the harvest by an appropriate survey (same state or stock where the fleet is operating) derived index of slot-sized fish for each year. The northern stock had one fishery performance indicator for NC, while the southern stock had two fishery performance indicators, one for SC and one for FL (no index of slot-sized fish in GA).

As in the simulation assessment, a grid search was performed to optimize the threshold (in reference to proportion red), number of consecutive years to trigger management action, and appropriate lag (when appropriate for sub-adults). In the simulation assessment, the grid search used information from the entire time series of the simulation, including the projection years, allowing the TLA to leverage information not available to the other models and unavailable to a TLA based on *in situ* data. Based on comments from the assessment review panel, it was recommended that only historic data should be used for optimization in future efforts (Section 1.3.2), and thresholds in this assessment were optimized using this recommended approach.

The grid search was performed for each year in the historic time-series and each characteristic over 100 simulated datasets for each of the core population dynamics scenarios (ASMFC 2022) and for both the northern and southern red drum stocks. The grid matrix consisted of potential threshold values ranging from 0.05 to 0.95 by 0.05 increments, and number of consecutive years to trigger management action from 1 to 10 years. The final optimized values for threshold and number of consecutive years to trigger management action were then applied to the observed data for each stock, scenario, corresponding characteristic, iteration, and for each year to calculate the proportion red and whether a management action was triggered.

The results for each individual characteristic were presented in chart form, displaying the annual color proportion relative to the threshold values. This allowed for the observation of annual variation and trends in characteristic conditions. Annual action determinations, based on thresholds and the number of years needed for a trigger, were produced in table form.

Stock status determinations are made from the TLA results (output table) according to the following scenarios:

- If fishery performance is red in any of the past three years, overfishing is occurring.
- If adult abundance is red in any of the past three years, the stock is overfished.

The SAS decided to include any of the past three years in stock status determinations to counter the risk of waiting too long to indicate poor stock status. Anywhere from six to ten consecutive years of proportion red exceeding thresholds are required for these metrics before indicating poor stock status in table form.

Additionally, the following scenarios represent concerning trends in the stock that the SAS recommends trigger action:

- If fishery performance is yellow in any of the past three years and recruitment is red for five consecutive years (a generation of the vulnerable population), there has been consistent below average recruitment and increasing catch and/or decreasing sub-adult abundance.
- If both fishery performance and adult abundance in any of the past three years are yellow, the stock is experiencing increasing catch and/or decreasing sub-adult abundance which is leading to declines in adult abundance.
- If recruitment is red for five consecutive years and adult abundance is yellow in any of the past three years, there has been consistent below average recruitment representing concern for the future of the adult abundance.

### **6.3.3 Results**

The threshold values estimated by the TLA were somewhat different from those in the simulation assessment, but similar for the northern (Table 77) and southern stocks (Table 78)

and. In general, the thresholds optimized using the historic only data were higher and had a greater number of years to trigger an action. This would seem to make sense based on there being less data in the shorter timeframe, leading to greater uncertainty in status determination for the model.

One decision that was made relative to the adult abundance characteristic was to halve (0.39) the optimized threshold value (0.78) to provide a more conservative determination for that value. This was based on the maturation and maximum age of red drum, where the adult population consists of many older age-classes. A decline in this older age-structure would have significant effects on the recruitment and stability of the population as a whole and using the higher threshold may not give managers adequate time to respond with corrective actions.

The final TLA status determinations for the 2021 fishing year varied by stock and characteristic (Table 80 and Table 79). The northern stock was determined to be yellow, triggering moderate management action, in the recruitment and fishery performance categories, while being green, triggering no action, for the adult abundance characteristic. Annual trends were less apparent, although there was a noticeable decline in fishery condition (Figure 195). The southern stock was red, indicating overfishing and triggering elevated management action, in the recruitment and fishery performance categories, while being yellow, triggering moderate action, for the adult abundance characteristic. The annual indicators suggest a possible declining trend for all three southern stock condition characteristics (Figure 196).

The TLA model results were insensitive to the selection of the reference period. For either stock the results of individual runs were either the same as the base period or only one category was different (Table 81 and Table 82). Of the 8 alternative reference periods for the northern stock, 6 had the same result as the base and 2 showed a decline to elevated action in the fishery performance category. Of the 11 alternative reference periods for the southern stock, 4 had the same result as the base and 7 showed an improvement to no action for the adult abundance category. The results were robust, but may be less so in cases where trends are stronger and individual years had results closer to thresholds. It was also observed that years within the reference period that noticeably deviated from the mean or outliers could have a strong effect on status determination.

## **6.4 Skate Data Limited Control Rule Method**

### **6.4.1 Background**

The Skate control rule method is a data-limited analysis developed to produce fishing mortality information using time series of observed catch and a survey index when fishing mortality cannot be calculated using stock assessment modeling or when estimates are uncertain (*i.e.*, questions about scaling; NEFSC 2020). The method uses a ratio of catch:index, using moving averages of each, to visualize how these two data streams co-vary through time:

$$Catch/Index_y = \frac{\frac{\sum_{y-a}^y Catch}{a+1}}{\frac{\sum_{y-a}^y Index}{a+1}}$$

where  $y$  is year  $y$  and  $a$  is an integer controlling the span of a moving average (e.g., if  $a = 2$ , three year-moving average). Increases in the ratio indicate increasing catch (i.e., increase in the numerator) and stable to declining relative abundance (i.e., denominator same or decreasing), stable catch (i.e., numerator constant) and decreasing relative abundance (i.e., denominator increasing), or decreases in both, with a larger decrease in relative abundance compared to catch (i.e., both numerator and denominator decreasing but decrease in denominator > numerator). Any of these scenarios can be indicative of unsustainable fishing pressure (e.g., overfishing).

The method defines a critical value of “relative  $F$ ” as the median ratio over the entire time series:

$$\text{Relative } F = \text{median}\left(Catch/Index\right)$$

Subsequently, recommended annual catch ( $C_{rec,y}$ ) is calculated as

$$C_{rec,y} = Catch/Index_y * \text{Relative } F,$$

and proportional change in catch in year  $y$  relative to catch in year  $y - 1$  is

$$Catch \Delta = \frac{C_{rec,y} - \frac{\sum_{y-a-1}^{y-1} Catch}{a+1}}{\frac{\sum_{y-a-1}^{y-1} Catch}{a+1}}$$

To aid in comparisons in catch advice across multiple catch and index time series (e.g., from different spatial areas), one can calculate a normalized catch:index ratio in year  $y$  as

$$Catch/Index_{norm,y} = \frac{Catch/Index_y}{\text{Relative } F}$$

for individual catch and index data streams. Once normalized, any ratio exceeding a value of one suggests unsustainable catch in year  $y$  given observed catch and index values and the range of values over the time series. The method proves useful in providing catch advice for the following year, particularly when the stock is determined to be experiencing overfishing and a reduction in catch is needed.

The Skate method, of several data limited approaches evaluated by the SAS (e.g., *ITarget* and other methods) capable of providing catch advice, was chosen as the preferred method. This was because the Skate method provides a current measure of exploitation on the most vulnerable portion of the stock that can be compared to reference levels and evaluated for

relative changes over time. The other methods considered used the recent impact of catch on the index of abundance to determine catch advice which is not appropriate for a recruitment-based fishery using an index of abundance that does not capture the cumulative effect of catch over time on the population due to rapid emigration offshore.

Herein, given the nature of the red drum fishery, the SAS decided to examine the relative  $F$  for the sub-adult population (i.e., segment of the population susceptible to harvest fisheries). For the southern stock, we used two sub-adult surveys to represent the index: the SC\_Trammel survey (only ages two and three; Table 84) and the FL\_183\_HaulSeine survey (Table 85). These indices were compared to each state's respective recreational harvest (Table 84 and Table 85) as estimated using the MRIP survey to develop annual catch:index ratios and subsequent relative  $F$ s. For the northern population a single sub-adult index was available for consideration, namely the NC\_GillNet survey. Hence, this index was compared to the entire northern stock's commercial and recreational catch (Table 83). For both stocks, 3-yr moving averages (i.e.,  $a = 2$ ) of catch and index time series were used in the calculation of catch:index ratios and relative  $F$ s. To be consistent with other analyses presented herein, the terminal year for estimation of relative  $F$  was the 2021 fishing year (September 1, 2021 – August 31, 2022), though index and catch data was available for the 2022 fishing year. Sensitivity analyses suggested exclusion of data from the 2022 fishing year in estimation of relative  $F$  did not substantially change catch advice.

#### 6.4.2 Results

For the northern stock, the relative  $F$  using the NC\_GillNet survey was calculated at 175.7. The annual catch:index ratio exceeded the relative  $F$  from 2015-2021 (Table 83 and Figure 197). The combined commercial and recreational catches in the northern stock have exceeded the recommended catch in six of the past seven years (Figure 198). The Skate method calculated an average proportional reduction in catch of 0.228 has been needed for 2015 through 2021 (Table 83 and Figure 199).

The relative  $F$  for the southern stock using the SC\_Trammel survey (ages-2 and -3 only) and South Carolina recreational catch was calculated at 98.02. The annual catch:Index ratio exceeded the relative  $F$  since 2010 (Table 84 and Figure 200), over the six-year management trigger used in the TLA. The South Carolina recreational catch has exceeded the recommended catch for the last 12 years when including preliminary data available for the 2022 fishing year (Table 84 and Figure 201). The Skate method calculated an average proportional reduction in catch of 0.669 has been needed across the 2012 to 2021 fishing years (Table 84 and Figure 202).

The relative  $F$  for the southern stock using the FL\_183\_HaulSeine survey was calculated at 218,231. The annual catch:index ratio exceeded the relative  $F$  from 2013 to 2021 (Table 85 and Figure 200). Based on the six-year management trigger, management actions would be needed using this method. The Florida recreational catch has exceeded the recommended catch for the last 9 years (Table 85 and Figure 203). The Skate method calculated an average proportional



reduction in catch of 0.476 has been needed for 2012 through 2021 fishing years (Table 85 and Figure 202).

## **7 STOCK STATUS**

### **Northern Stock**

Due to uncertainty and instability in the northern stock SS model, the model was not deemed satisfactory for stock status determination. However, it should be noted that results showing increasing trends in F coincide with increasing F trends observed in both the TLA analysis and Skate method.

The TLA, used for this stock as the primary stock status determination methodology, established that the northern stock is neither experiencing overfishing nor is the stock overfished. There is some level of uncertainty within this analysis, as the TLA for this stock appears to be heavily influenced by observations of a strong year class in 2011. However, this effect is decreasing in the most recent years as all three metrics are near exceeding TLA thresholds by the terminal year of the assessment. Overfishing is defined by fishery performance, the threshold for which is a red indicator in any one of the last three terminal years. In the case of the northern stock, the TLA has shown yellow indicators for all three of the terminal three years, suggesting levels of moderate action from management. However, fishery performance has been showing increasing proportions of red since the mid-2000s. Specifically, six of the seven previous years that have available data have shown some proportions of red (2016-2022), while only one year (2011) was red from 2003-2015, with three years (2003-2005) being green. This trend points to increased fishing effort across the northern stock, consistently approaching threshold values. Per the TLA reference points, an overfished status is only triggered when adult abundance is also red in any one of three previous years. For the northern stock, an overfished status was not determined as none of the three terminal years were at red (elevated action) levels. Similar to fishery performance, adult abundance is being shown to trend towards yellow and red designations in recent years. Specifically, the period of 2019 to 2022 has shown two years in the yellow designation and the terminal year (2022) in red. This contrasts with the period from 2012 to 2018 in which six of the years were green with only one year in yellow. As mentioned, when discussing the southern stock, any indication of a trend of decreasing adult abundance or increasing proportions of red values in the fishery performance metric should be considered by management. The life history of red drum is such that should these values exceed the thresholds established in this report, it will likely take a long period of corrective management to return these values to acceptable levels.

The Skate method was used for the northern stock as a complementary analysis to the TLA and as a means to provide quantitative catch advice, should it be needed. This method identified an extended period of overfishing utilizing the NC\_GillNet survey index and regional catch data. This methodology indicated that F values have been steadily increasing since the beginning of the time series (2005), finally exceeding the overfishing threshold for the stock in 2015. To prevent this designation, a relative decrease in catch on the order of 23% would have been needed in the northern stock since approximately 2015. The Skate analysis represents a more

risk adverse (e.g., lower risk) approach to management due to its shorter integration period (3 years) vs. the longer integration period needed for the TLA (7 years for fishery performance and 10 years for adult abundance). All three analyses suggest recent increasing trends in F. The northern stock is still data limited throughout the entire range, most noticeably north of North Carolina. This lack of data leads to increased stock uncertainty, further fueled by the trend of increasing catch in Virginia.

### **Southern Stock**

The SS model is the preferred tool for stock status determination for the southern stock. The model revealed overall decreasing SPR and relative SSB values in the recent years of the assessment. In fact, the model indicates that both values in the southern stock are now approaching levels last observed in the early to mid-1980s. Both annual SPR and three-year average SPR have been showing decreasing trends for much of the time period referenced in this report. Since approximately 2013, overfishing has been occurring with this stock as indicated by the SPR values, which have dropped below the threshold value of 30% and have remained there through the terminal year (2021). Similarly, trends in the SSB values for the southern stock have shown a decreasing pattern since approximately 2008. The recent indicators show that the stock has been overfished since approximately 2018, with SSB values dropping below the 30% threshold and remaining there through the terminal year. Although not defined in previous assessments, a 30% threshold for SSB was established in this report due to its association with the SPR threshold.

The TLA, in this case used as a complementary method to the SS model, corroborated much of the results revealed using the SS model. Using the TLA, overfishing is defined by fishery performance, the threshold for which is a red indicator in any one of the last three terminal years. In the case of the southern stock, the TLA has shown red indicators for all three of the terminal assessment years, indicating the stock has been experiencing overfishing since approximately 2018. However, where the TLA differs from the SS method is in the determination of the overfished status. Per the TLA reference points, an overfished status is only triggered when adult abundance is also red in any one of three previous years. Per this analysis, an overfished status was not determined as the three terminal years were not at red (elevated action) levels. A primary cause of this discrepancy is likely the inclusion of the GA\_Longline survey index in the TLA and the exclusion of this index from the SS model. The GA\_Longline survey index provides a conflicting trend with the SC\_Longline\_contemporary survey index, which led to the GA\_Longline survey index being excluded from the SS model. However, adult abundance has been at yellow (moderate action) levels since 2018. Further, two additional management triggers using adult abundance in combination with fishery performance and recruitment as the reference points did trigger using this analysis. The criteria of these triggers are 1) both fishery performance and adult abundance are yellow (or red) in any of the last three years and 2) recruitment has been red for five consecutive years and adult abundance has been yellow in any of the past three years. The first trigger indicates signs of increasing catch and/or decreasing sub-adult abundance. The second trigger is a sign of consistent, below average recruitment, which indicates increasing chances of future declines in adult abundance. These secondary triggers are especially important for a long-lived species like

red drum, where continued trends of decreased adult abundance and poor recruitment indicate the need for corrective management long before adult abundance reaches the red threshold levels.

Two additional complementary analyses were conducted, the Skate method and the Cormack-Jolly-Seber model, both of which identified increasing trends in  $F$  in recent years and an extended period of non-sustainable catch in the case of the Skate method. The Skate method identified an extended period of overfishing utilizing data from both the SC\_Trammel and FL\_183\_HaulSeine surveys, and regional catch data. In both states, this methodology indicated that overfishing has been occurring since the early 2010s, resulting in an overfishing designation for the stock since approximately 2012. In the case of Florida, a relative decrease in catch on the order of 48% would have been needed since 2012 to prevent this designation and South Carolina would have needed a 67% decreased relative catch to avoid overfishing. Similarly, the Cormack-Jolly-Seber Method has shown declining annual apparent survival in age-1 to -3 fish across the study period. This value is analogous to increasing levels of  $F$  and matches the observations from the SS, TLA, and Skate analyses (Figure 204).

## **8 FUTURE ASSESSMENTS AND RESEARCH RECOMMENDATIONS**

The SAS recommends conducting the next benchmark assessment in five years to allow for six additional fishing years (through 2027) of data past the terminal year in this assessment. The SAS does not recommend allowing a greater period between assessments due to the condition of the stocks in this assessment.

Before the next benchmark assessment, the SAS recommends updating the TLAs every two years, with the first update using the 2023 fishing year as the terminal year and the second update using the 2025 fishing year as the terminal year.

The SAS also encourages work on the following prioritized research recommendations (priority level bolded and italicized). Work on all high priority recommendations should commence immediately. Short-term recommendations are those that would take less time (1-5 years) to produce results to support future assessments. Long-term recommendations are those that will take a longer period of time (5-10+ years) to produce results to support future assessments.

### Short-Term

- Develop methods (e.g., voluntary logbook programs, catch cards, app reporting) to estimate recreational discard catch length composition coastwide. Several apps have been developed or are under development to provide these data, but quantity and quality of data collected still need to be assessed (*high*).
- Greater intensity of age sampling coastwide is needed for adults to better characterize year class strength when size-at-age overlaps considerably (*high*).

- Collect data to estimate movement rates (e.g., acoustic tagging) of sub-adults in inshore waters to the adult population in offshore/nearshore waters for development of a multi-area assessment model. NC has received funding for a satellite tagging study, but efforts are needed in all stock areas (*high*).
- Expand observer coverage to include other gears of concern (i.e., haul seine, purse seines, pound nets; *moderate*).
- Expand biostatistical sampling (ages and lengths) to better cover all statistical strata (gears/states/seasons) and collect more otolith ages proportional to lengths. Conduct statistical analysis to determine appropriate sample sizes to adequately characterize the age-size composition of removals. Greater sampling would support development of seasonal models (*moderate*).
- Determine batch fecundity estimates of red drum to support fecundity-based assessment. Age-specific spawning frequency and spawning season length needs to be included for this indeterminate spawner (*moderate*).
- Update maturity schedules for Atlantic red drum from Florida to Virginia. Preferably, gonad histology samples should be collected from all sizes over time and archived. South Carolina collects data, but data are needed from all other states (*moderate*).
- Continue and expand observer coverage for the NC and VA gill net fisheries to quantify total discards and size compositions with a goal of reaching CVs of 0.2 or less (*low*).
- Further study is needed to determine discard mortality estimates for the Atlantic coast, both for recreational and commercial gears. Additionally, discard estimates should examine the impact of slot-size limit management and explore regulatory discard impacts due to high-grading. Covariates affecting discard mortality (e.g., depth, size, seasonality, terminal tackle) should be investigated. Some work has been done to estimate discard mortality rates for adults in SC (*low*).
- Determine contributions of stocked fish to wild populations and their impacts to stock status for the southern stock. A data set of fin clips exist in SC that could be analyzed for this (*low*).
- Investigate reference points for red drum management. Potential to use operating model to do so (*low*).

#### Long-Term

- Expand tag-recapture analyses to states outside South Carolina. Further explore other tag-recapture models to use all available tag data (*high*).

- Index sub-adult abundance in VA inshore estuarine waters with non-trawl gears (e.g., seine or other net surveys; *high*)
- Develop longline surveys (with age sampling) targeting adult red drum at the northern and southern extents of the population range (*high*).
- Investigate a seasonal model to provide greater resolution on growth data (i.e., conditional age-at-length) within a fishing year. See work done during this assessment to evaluate data for supporting seasonal time steps (*high*).
- Incorporate tag-recapture data directly into assessment models used for stock status determination (*moderate*).
- Identify impacts of water quality, environmental, ecosystem, and habitat changes on red drum stock dynamics. Incorporate in stock assessment models (*moderate*).
- Investigate a two-area model that separates fish between inshore/offshore areas to better differentiate life history stages (older sub-adults vs. mature adults) that can't be as clearly separated by available data (i.e., lengths). Data to inform movement rates between areas will be needed which are essentially the same data to inform descending selectivity of the recreational fishery. Catch data will also need to be split into areas (*moderate*).

## 9 REFERENCES

- Atlantic Coastal Cooperative Statistics Program (ACCSP). 2016. Proceedings of the workshop on percent standard error (PSE) of recreational fishing data. Arlington, VA.
- Adams, D. H. and D. M. Tremain. 2000. Association of large juvenile red drum, *Sciaenops ocellatus*, with an estuarine creek on the Atlantic coast of Florida. *Environmental Biology of Fishes* 58: 183–194.
- Addis, D. 2020. The 2020 stock assessment of red drum, *Sciaenops ocellatus*, in Florida. Florida Fish and Wildlife Research Institute. IHR 2020-002. St. Petersburg, FL.
- Agresti, A. 2002. *Categorical Data*. Second Edition. Wiley
- Akaike, H. 1974. A new look at the statistical model identification. *IEEE Trans. Auto. Control* 19:716–723.
- Alverson, D. L. and M. J. Carney. 1975. A graphic review of the growth and decay of population cohorts. *Journal du Conseil / Conseil permanent International pour l'Exploration de la Mer* 36: 133-143.
- Anderson, S.C., C.C. Monnahan, K.F. Johnson, K. Ono, and J.L. Valero. 2014. ss3sim: An R package for fisheries stock assessment simulation with Stock Synthesis. *PLOS ONE*. 9(4): e92725. <http://doi.org/10.1371/journal.pone.0092725>.

- Arnott S.A., W.A. Roumillat, J.A. Archambault, C.A. Wenner, J.I. Gerhard, T.L. Darden, and M.R. Denson. 2010. Spatial synchrony and temporal dynamics of juvenile red drum *Sciaenops ocellatus* populations in South Carolina, USA. *Marine Ecology Progress Series* 415: 221-236.
- Arnott, S. 2015a. Red drum maturity analysis. SEDAR44-DW-02. SEDAR, North Charleston, SC.
- Arnott, S. 2015b. Distance moved by red drum recaptured by recreational anglers. SEDAR44-DW03. SEDAR, North Charleston, SC.
- Arnott, S. and L. Paramore. 2015. Sizes of tag recaptured red drum that were released alive by recreational anglers. SEDAR44-DW05. SEDAR. North Charleston, SC.
- ASMFC (Atlantic States Marine Fisheries Commission). 1984. Fisheries Management Report No. 5 of the Atlantic States Marine Fisheries Commission: Fishery Management Plan for Red Drum. Washington, DC. October 1984.
- ASMFC. 2002. Amendment 2 to the Interstate Fishery Management Plan for Red Drum; Fishery Management Report No. 38 of the Atlantic States Marine Fisheries Commission. ASMFC.
- ASMFC. 2003. Amendment 6 to the Interstate Fishery Management Plan for Atlantic Striped Bass. Atlantic States Marine Fisheries Commission. Washington, DC.
- ASMFC. 2008. Proceedings of an Atlantic Croaker and Red drum Ageing Workshop. Washington, D.C.
- ASMFC. 2017a. Amendment 3 to the Interstate Fishery Management Plan for Atlantic Menhaden. Atlantic States Marine Fisheries Commission. Arlington, VA.
- ASMFC. 2017b. Red Drum Benchmark Stock Assessment and Peer Review Report. Atlantic States Marine Fisheries Commission. Arlington, VA.
- ASMFC. 2020. Traffic Light Analysis of Atlantic croaker (*Micropogonias undulatus*). Atlantic States Marine Fisheries Commission. Arlington, VA.
- ASMFC. 2022. Red Drum Simulation Assessment and Peer Review Report. ASMFC. Arlington, VA.
- ASMFC. 2024. Fish habitat of concern designations for fish and shellfish species. Atlantic States Marine Fisheries Commission Habitat Committee, Arlington, VA.
- Bacheler, N.M., J.E. Hightower, L.M. Paramore, J.A. Buckel, and K.H. Pollock. 2008. An age-dependent tag return model for estimating mortality and selectivity of an estuarine dependent fish with high rates of catch and release. *Transactions of American Fisheries Society* 137: 1422-1432.

- Bacheler, N. M., L.M. Paramore, S.M. Burdick, J.A. Buckel, and J.E. Hightower. 2009. Variation in movement patterns of red drum *Sciaenops ocellatus* inferred from conventional tagging and ultrasonic tracking. *Fishery Bulletin* 107: 405-419.
- Bacheler, N.M., J.E. Hightower, S.M. Burdick, L. M. Paramore, J. A. Buckel, and K. H. Pollock. 2010. Using generalized linear models to estimate selectivity from short-term recoveries of tagged red drum *Sciaenops ocellatus*: Effects of gear, fate, and regulation period. *Fisheries Research* 102: 266-275.
- Baltz, D. M., J. W. Fleeger, C. F. Rakocinski, and J. N. McCall. 1998. Food, density, and microhabitat: Factors affecting growth and recruitment potential of juvenile saltmarsh fishes. *Environmental Biology of Fishes* 53: 89–103.
- Bass, R. J. and J. W. Avault Jr. 1975. Food habit, length-weight relationship, condition factor, and growth of juvenile red drum, *Sciaenops ocellatus*, in Louisiana. *Transactions of the American Fisheries Society* 104(1): 35–45.
- Baulier, L. and M. Heino. 2008. Norwegian spring-spawning herring as the test case of piecewise linear regression method for detecting maturation from growth patterns. *Journal of Fish Biology*, 73: 2451-2467.
- Beaumarrige, D. S. 1969. Returns from the 1965 Schlitz tagging program, including a cumulative analysis of previous results. Florida Department of Natural Resources Technical Series 59: 1–38.
- Beck, M. W., K. L. Heck, K. W. Able, D. L. Childers, D. B. Eggleston, B. M. Gillanders, B. Halpern, C. G. Hays, K. Hoshino, T. J. Minello, R. J. Orth, P. F. Sheridan, and M. P. Weinstein. 2001. The identification, conservation, and management of Estuarine and Marine Nurseries for Fish and Invertebrates. *BioScience* 51(8): 633–641.
- Beckwith, A. B., G. H. Beckwith, Jr., and P. S. Rand. 2006. Identification of critical spawning habitat and male courtship vocalization characteristics of red drum, *Sciaenops ocellatus*, in the lower Neuse River estuary of North Carolina. North Carolina Sea Grant Fishery Research Grant Program, Final Report 05-EP-05.
- Beddington, J.R. and J.G. Cooke. 1983. The potential yield of fish stocks. Food and Agriculture Organization fisheries technical paper 242: 1-47.
- Brown-Peterson, N.J., D.M. Wyanski, F. Saborido-Rey, B.J. Macewicz, and S.K. Lowerre-Barbieri. 2011. A standardized terminology for describing reproductive development in fishes. *Marine and Coastal Fisheries: Dynamics, Management, and Ecosystem Science* 3: 52-70.
- Buckley, J. 1984. Habitat suitability index models: Larval and juvenile red drum. U.S. Fish and Wildlife Service. pp. 1–25.

- Burdick, S. M., J. E. Hightower, J. A. Buckel, K. H. Pollock, and L. M. Paramore. 2007. Movement and selectivity of red drum and survival of adult red drum: an analysis of 20 years of tagging data. North Carolina Division of Marine Fisheries, Morehead City, NC.
- Caddy, J. F. 1998. A short review of precautionary reference points and some proposals for their use in data-poor situations. Food and Agriculture Organization fisheries technical paper 379.
- Caddy, J.F. 1999. Deciding on precautionary management measures for a stock based on a suite of limit reference points (LRPs) as a basis for a multi-LRP Harvest Law. Scientific council studies. Northwest Atlantic Fisheries Organization. Dartmouth NS 55–68.
- Caddy, J.F., Mahon, R. 1995. Reference points for fisheries management. Food and Agriculture Organization of the United Nations Rome.
- Caddy, J.F., E. Wade, T. Surette, M. Hebert, and M. Moriyasu. 2005. Using an empirical traffic light procedure for monitoring and forecasting in the Gulf of St. Lawrence fishery for the snow crab, *Chionoecetes opilio*. Fisheries Research 76: 123–145.  
<https://doi.org/10.1016/j.fishres.2005.06.003>
- Cadigan, N. 2009. Nonparametric growth model for Atlantic red drum, and changes to natural mortality (M) estimates. SEDAR Working Paper 18-AW02.
- Carvalho F., H. Winker, D. Courtney, M. Kapur, L. Kell, M. Cardinale, and M. Schirripa. 2021. A cookbook for using model diagnostics in integrated stock assessments. Fisheries Research 240: 105959.
- Chagaris, D., B. Mahmoudi, and M. Murphy. 2015. The 2015 stock assessment of red drum, *Sciaenops ocellatus*, in Florida. Florida Fish and Wildlife Research Institute. IHR-2015-003. St. Petersburg, FL.
- Chapman, R. W., A. O. Ball and L. R. Mash. 2002. Spatial homogeneity and temporal heterogeneity of red drum (*Sciaenops ocellatus*) microsatellites: Effective population sizes and management implications. Marine Biotechnology 4: 589-603.
- Charnov, E.L, H. Gislason, and J.G. Pope. 2013. Evolutionary assembly rules for fish life histories. Fish and Fisheries 14(2): 213-224.
- Chen, Y., M. Kanaiwa, and C. Wilson. 2005. Developing and evaluating a size-structured stock assessment model for the American lobster, *Homarus americanus*, fishery. New Zealand Journal of Marine and Freshwater Research 39(3): 645-660.
- Cochran, W.G. 1977. Sampling Techniques. 3rd Edition, John Wiley & Sons, New York.



- Comyns, B. H., J. Lyczkowski-Shultz, D. L. Nieland, and C. A. Wilson. 1991. Reproduction of red drum, *Sciaenops ocellatus*, in the Northcentral Gulf of Mexico: Seasonality and spawner biomass. U.S. Department of Commerce NOAA Technical Report NMFS 95: 17–26.
- Conn, P.B. 2010. Hierarchical analysis of multiple noisy abundance indices. *Canadian Journal of Fisheries and Aquatic Sciences* 67: 108-120.
- Crawley, M.J. 2007. *The R book*. John Wiley & Sons, Chichester, U.K.
- Cushing, D.H. 1975. *Marine ecology and fisheries*. Cambridge University Press, Cambridge, England.
- Cushman, E., M. Jamison, and T. Darden. 2014. Adult red drum genetic diversity and population structure. SEDAR Working Paper SEDAR44-DW01.
- Daniel, III, L. B. 1988. Aspects of the biology of juvenile red drum, *Sciaenops ocellatus*, and spotted seatrout, *Cynoscion nebulosus*, (Pisces: Sciaenidae) in South Carolina. M.S. Thesis. College of Charleston, Charleston, SC.
- Deroba, J.J., D.S. Butterworth, R.D. Methot, Jr., J.A.A. De Oliveira, C. Fernandez, A. Nielsen, S.X. Cadrin, M. Dickey-Collas, C.M. Legault, J. Ianelli, J.L. Valero, C.L. Needle, J.M. O'Malley, Y-J. Chang, G.G. Thompson, C. Canales, D.P. Swain, D.C.M. Miller, N.T. Hintzen, M. Bertignac, L. Ibaibarriaga, A. Silva, A. Murta, L.T. Kell, C.L. de Moor, A.M. Parma, C.M. Dichmont, V.R. Restrepo, Y. Ye, E. Jardim, P.D. Spencer, D.H. Hanselman, J. Blaylock, M. Mood, and P.J.F. Hulson. 2015. Simulation testing the robustness of stock assessment models to error: some results from the ICES strategic initiative on stock assessment methods. *ICES Journal of Marine Science* 72: 19–30.
- Francis, R.I.C.C. 2011. Data weighting in statistical fisheries stock assessment models. *Canadian Journal of Fisheries and Aquatic Sciences* 68(6): 1124–1138.
- FWCC (Florida Fish and Wildlife Conservation Commission). 2008. Red Drum, *Sciaenops ocellatus* stock assessment. Florida Fish and Wildlife Conservation Commission: Red Drum 61.
- Gimenez, O., Lebreton, J.-D., Choquet, R., & Pradel, R. (2018). R2ucare: An r package to perform goodness-of-fit tests for capture–recapture models. *Methods in Ecology and Evolution*, 9(7), 1749–1754. <https://doi.org/10.1111/2041-210X.13014>
- Gislason, H., N. Daan, J.C. Rice, and J.G. Pope. 2010. Size, growth, temperature and the natural mortality of marine fish. *Fish and Fisheries* 11(2): 149-158.
- Gold, J. R., C. P. Burrige, and T. F. Turner. 2001. A modified stepping-stone model of population structure in red drum, *Sciaenops ocellatus* (Sciaenidae), from the northern Gulf of Mexico. *Genetica* 111: 305-317.

- Gold, J. R. and T. F. Turner. 2002. Population structure of red drum (*Sciaenops ocellatus*) in the northern Gulf of Mexico, as inferred from variation in nuclear-encoded microsatellites. *Marine Biology* 140: 249-265.
- Goldberg, D. A., L. M. Paramore, and F. S. Scharf. 2021. Analysis of environment-recruitment associations for a coastal red drum population reveals consistent link between year class strength and early shifts in nearshore winds. *Fisheries Oceanography*: 1-14.  
<https://doi.org/10.1111/fog.12562>
- Gulland, J.A. 1983. *Fish Stock Assessment. A Manual of Basic Method*. FAO/Wiley Series on Food and Agriculture, Rome, 241 p.
- Haddon, M. 2011. *Modelling and Quantitative Methods in Fisheries*, second ed. CRC Press, Boca Raton.
- Halliday, R.G., L.P. Fanning, and R.K. Mohn. 2001. Use of the traffic light method in fishery management planning. *Canadian Science Advisory Secretariat*.
- Hamel, O.S., and Cope, J.M. 2022. Development and considerations for application of a longevity-based prior for the natural mortality rate. *Fish. Res.* 256. 106477.
- Hampton, J. 2000. Natural mortality rates in tropical tunas: size really does matter. *Canadian Journal of Fisheries and Aquatic Sciences*, 57(5), 1002-1010.
- Hewitt, D.A. and J.M. Hoenig. 2005. Comparison of two approaches for estimating natural mortality based on longevity. *Fishery Bulletin* 103: 433-437.
- Hilborn, R., and Walters, C.J. 1992. *Quantitative Fisheries Stock Assessment: Choice, Dynamics and Uncertainty*. Chapman & Hall, London, UK, p. 570.
- Hoenig, J.M. 1983. Empirical use of longevity data to estimate mortality rates. *Fishery Bulletin* 82: 898-903.
- Hoenig, J.M. 2017. Should natural mortality estimators based on maximum age also consider sample size? *Transactions of the American Fisheries Society* 146: 136-146.
- Hoenig, J. M., A. Y. Then, E. A. Babcock, N. G. Hall, D. A. Hewitt, and S. A. Hesp. 2016. The logic of comparative life history studies for estimating key parameters, with a focus on natural mortality rate. *ICES Journal of Marine Science* 73(10): 2453-2467.
- Holt, J., R. Godbout, and C. Arnold. 1981. Effects of temperature and salinity on egg hatching and larval survival of red drum *Sciaenops ocellatus*. *Fishery Bulletin* 79(3): 569–573.
- Holt S. A., C. L. Kitting, and C. R. Arnold. 1983. Distribution of young red drums among different sea-grass meadows. *Transactions of the American Fisheries Society* 112: 267–271.

- Holt, G. J., S. A. Holt, and C. R. Arnold. 1985. Diel periodicity of spawning in sciaenids. *Marine Ecology Progress Series* 27: 1–7.
- Holt, S. A., G. J. Holt, and C. R. Arnold. 1989. Tidal stream transport of larval fishes into non-stratified estuaries. *Rapports du Conseil International pour l'Exploration de la Mer* 191: 100–104.
- Houde E.D. 1987. Fish early life dynamics and recruitment variability. *American Fisheries Society Symposium* 2: 17-29.
- Hurtado-Ferro, F., C.S. Szuwalski, J.L. Valero, S.C. Anderson, C.J. Cunningham, K.F. Johnson, R. Licandeo, C.R. McGilliard, C.C. Monnahan, M.L. Muradian, K. Ono, K.A. Vert-Pre, A.R. Whitten, and A.E. Punt. 2014. Looking in the rear-view mirror: bias and retrospective patterns in integrated, age-structured stock assessment models. *ICES Journal of Marine Science* 72(1): 99–110.
- Jannke, T. 1971. Abundance of young sciaenid fishes in Everglades National Park, Florida, in relation to season and other variables. *University of Miami Sea Grant Technical Bulletin* 11.
- Jensen, A.L. 1996. Beverton and Holt life history invariants result from optimal trade-off of reproduction and survival. *Canadian Journal of Fisheries and Aquatic Sciences* 53: 820-822.
- Johnson, G. D. 1978. Development of fishes of the mid-Atlantic Bight. An atlas of egg, larval and juvenile stages. Vol IV. U.S. Fish and Wildlife Service, Biological Services Program. FSW/OBS-78/12: 190- 197.
- Johnson, D. R. and N. A. Funicelli. 1991. Estuarine spawning of the red drum in Mosquito Lagoon on the east coast of Florida. *Estuaries* 14: 74–79.
- Johnson, K.F., S.C. Anderson, K. Doering, C.C. Monnahan, C.C. Stawitz, and I.G. Taylor. 2021. ss3sim: Fisheries stock assessment simulation testing with Stock Synthesis. R package version 1.1.6.
- Jorde, P. E. and N. Ryman. 1995. Temporal allele frequency change and estimation of effective population size in populations with overlapping generations. *Genetics* 139: 1077-1090.
- Lo, N.C., L.D. Jacobson, and J.L. Squire. 1992. Indices of relative abundance from fish spotter data based on delta-lognormal models. *Canadian Journal Fisheries and Aquatic Sciences* 49: 2515-2526.
- Laake, J. L., Johnson, D. S., & Conn, P. B. (2013). marked: An R package for maximum likelihood and Markov Chain Monte Carlo analysis of capture–recapture data. *Methods in Ecology and Evolution*, 4(9), 885–890. <https://doi.org/10.1111/2041-210X.12065>

- Lebreton, J.-D., Burnham, K. P., Clobert, J., & Anderson, D. R. (1992). Modeling survival and testing biological hypotheses using marked animals: A unified approach with case studies. *Ecological Monographs*, 62(1), 67–118.
- Lenth, R.V. 2023. emmeans: Estimated marginal means, aka Least-Squares Means. R package version 1.8.5, <https://CRAN-R-project.org/package=emmeans>.
- Lorenzen, K. 1996. The relationship between body weight and natural mortality in juvenile and adult fish: a comparison of natural ecosystems and aquaculture. *Journal of Fish Biology* 49(4): 627-642.
- Lorenzen, K. 2000. Allometry of natural mortality as a basis for assessing optimal release size in fish-stocking programmes. *Canadian Journal of Fisheries and Aquatic Sciences* 57(12): 2734-2381.
- Lorenzen, K. 2005. Population dynamics and potential of fisheries stock enhancement: practical theory for assessment and policy analysis. *Philosophical Transactions of the Royal Society B* 360: 171-189.
- Lorenzen, K. 2022. Size- and age-dependent natural mortality in fish populations: Biology, models, implications, and a generalized length-inverse mortality paradigm. *Fish. Res.* 255, 106454.
- Lorenzen, K., Camp, E.V., and Garlock, T.M. 2022. Natural mortality and body size in fish populations. *Fish. Res.* 252, 106327.
- Lowerre-Barbieri, S.K., L.R. Barbieri, J.R. Flanders, A.G. Woodward, C.F. Cotton, and M.K. Knowlton. 2008. Use of passive acoustics to determine red drum spawning in Georgia waters. *Transactions of the American Fisheries Society* 137: 562-575.
- Luczkovich, J. J., H. J. Daniel, III, and M. W. Sprague. 1999. Characterization of critical spawning habitats of weakfish, spotted seatrout and red drum in Pamlico Sound using hydroplane surveys. Completion Report, F-62, NC Division of Marine Fisheries, Morehead City, NC.
- Lux, F.E. and J.V. Mahoney. 1969. First records of the channel bass, *Sciaenops ocellatus*, in the Gulf of Maine. *Copeia* 1969: 632–633.
- Lyczkowski-Shultz, J. and J. P. Steen, Jr. 1991. Diel vertical distribution of red drum *Sciaenops ocellatus* larvae in the northcentral Gulf of Mexico. *Fishery Bulletin* 89: 631–641.
- Mansueti, R. J. 1960. Restriction of very young red drum, (*Sciaenops ocellata*) to shallow estuarine waters of the Chesapeake Bay during late autumn. *Chesapeake Science* 1: 207–210.

- Marks Jr., R. E. and G. P. DiDomenico. 1996. Tagging studies, maturity, and spawning seasonality of red drum (*Sciaenops ocellatus*) in North Carolina. Completion Report Grant F-43, 1–39.
- Maunder, M.N., Hamel, O.S., Lee, H., Piner, K.R., Cope, J.M., Punt, A.E., Ianelli, J.N., Castillo-Jordan, C., Kapur, M.S., and Methot, R.D. 2023. A review of estimation methods for natural mortality and their performance in the context of fishery stock assessment. *Fish. Res.* 257, 106489.
- McGovern, J. C. 1986. Seasonal recruitment of larval and juvenile fishes into impounded and nonimpounded marshes. MS Thesis. College of Charleston, Charleston, SC.
- Mercer, L.P. 1984. A biological and fisheries profile of red drum, *Sciaenops ocellatus*. North Carolina Division of Marine Fisheries, Special Scientific Report 41, Morehead City.
- Methot, R.D. and I.G. Taylor. 2011. Adjusting for bias due to variability of estimated recruitments in fishery assessment models. *Canadian Journal of Fisheries and Aquatic Sciences* 68: 1744-1760.
- Methot, R.D. and C.R. Wetzel. 2013. Stock Synthesis: A biological and statistical framework for fish stock assessment and fishery management. *Fisheries Research*.  
<http://dx.doi.org/10.1016/j.fishres.2012.10.012>.
- Methot, R.D., C.R. Wetzel, I.G. Taylor, K.L. Doering, and K.F. Johnson. 2023. Stock Synthesis User Manual Version 3.30.21. NOAA Fisheries, Seattle, WA.
- Miles, D. W. 1950. The life histories of spotted seatrout, *Cynoscion nebulosus*, and the redfish, *Sciaenops ocellatus*. Texas Game, Fish and Oyster Commission, Marine Laboratory Annual Report (1949- 1950): 66–103.
- Minello, T. J. and G. W. Stunz. 2001. Habitat-related predation on juvenile wild-caught and hatchery-reared red drum *Sciaenops ocellatus* (Linnaeus). *Journal of Experimental Marine Biology and Ecology* 260: 13–25.
- Murphy, M.D. and R.G. Taylor. 1990. Reproduction, growth, and mortality of red drum *Sciaenops ocellatus* in Florida waters. *Fishery Bulletin* 88: 531-542.
- Murphy, M. D. 2017. An assessment of red drum in South Carolina, 1982-2016. SC DNR.
- Murphy, M. D. 2009. Reported commercial landings of red drum in Florida and estimated annual length and age composition. SEDAR-18-DW08 working paper.
- Music, J.F. and J.M. Pafford. 1984. Population dynamics and life history aspects of major marine sportfishes in Georgia coastal waters. Georgia Department of Natural Resources. Coastal Resources Division Cont. Ser. 38, Atlanta.

- NEFSC. 2020. Draft Report of the Index Based Methods Working Group. Northeast Fisheries Science Center, Woods Hole, MA. 59 pages.
- Neill, W. H. 1987. Environmental requirements of red drum. In: Chamberlain, G. W. (ed) Manual on Red Drum Aquaculture. Preliminary draft of invited papers presented at the Production Shortcourse of the 1987 Red Drum Aquaculture Conference on 22–24 June, 1987 in Corpus Christi, Texas. Texas A & M University, College Station, TX.
- Nelson, D. M., E. A. Irlandi, L. R. Settle, M. E. Monaco, and L. Coston-Clements. 1991. Distribution and abundance of fishes and invertebrates in southeast estuaries. ELMR Report No. 9, NOAA/NOS Strategic Environmental Assessments Division, Silver Spring, MD. pp. 167.
- Nelson, G. 2014. Cluster sampling: A pervasive, yet little recognized survey design in fisheries research. *Transactions of the American Fisheries Society* 143(4): 926-938.
- Nicholson, N. and S. R. Jordan. 1994. Biotelemetry study of red drum in Georgia. Georgia Department of Natural Resources, Brunswick, GA.
- Odell, J., D. H. Adams, B. Boutin, W. Collier II, A. Deary, L. N. Havel, J. A. Johnson Jr., S. R. Midway, J. Murray, K. Smith, K. M. Wilke, and M. W. Yuen. 2017. Atlantic Sciaenid habitats: A review of utilization, threats, and recommendations for conservation, management, and research. Atlantic States Marine Fisheries Commission Habitat Management Series No. 14, Arlington, VA.
- Ogle, D.H. 2018. *Introductory Fisheries Analyses with R*. Chapman and Hall/CRC.
- Ogle, D. H., Doll, J. C., Wheeler, A. P., & Dinno, A. (2023). *FSA: Simple Fisheries Stock Assessment Methods*. <https://CRAN.R-project.org/package=FSA>
- Osburn, H. R., G. C. Matlock, and A. W. Green. 1982. Red drum (*Sciaenops ocellatus*) movement in Texas bays. *Contributions in Marine Science* 25: 85–97.
- Pafford, J. M., A. G. Woodward, and N. Nicholson. 1990. Mortality, movement and growth of red drum in Georgia. Final report. Georgia Department of Natural Resources, Brunswick.
- Pattillo, M. E., T. E. Czapl, D. M. Nelson, and M. E. Monaco. 1997. Distribution and abundance of fishes and invertebrates in Gulf of Mexico estuaries, volume 2: species life history summaries. NOAA, NOS Strategic Environmental Assessments Division, Silver Spring, Maryland.
- Pauly, D. 1980. On the interrelationships between natural mortality, growth parameters, and mean environmental temperature in 175 fish stocks. *Journal du Conseil / Conseil permanent International pour l'Exploration de la Mer* 39: 175-192.

- Pearson, J. C. 1929. Natural history and conservation of the redfish and other commercial sciaenids on the Texas coast. *Bulletin of the U.S. Bureau of Fish Commission* 44: 129–214.
- Peters, K. M. and R. H. McMichael. 1987. Early life history of the red drum, *Sciaenops ocellatus* (Pisces: Sciaenidae), in Tampa Bay, Florida. *Estuaries* 10(2): 92–107.
- Pollock, K. H., Nichols, J. D., Brownie, C., & Hines, J. E. (1990). Statistical Inference for Capture-Recapture Experiments. *Wildlife Monographs*, 107, 3–97.
- Porch, C.E., C. A. Wilson, and D. L. Nieland. 2002. A new growth model for red drum (*Sciaenops ocellatus*) that accommodates seasonal and ontogenic changes in growth rates. *Fishery Bulletin* 100: 149-152.
- Pradel, R. (1993). Flexibility in survival analysis from recapture data: Handling trap-dependence. *Marked Individuals in the Study of Bird Populations*, 29–37.
- Pradel, R., Hines, J. E., Lebreton, J.-D., & Nichols, J. D. (1997). Capture-recapture survival models taking account of transients. *Biometrics*, 60–72.
- Pradel, R., Wintrebert, C. M., & Gimenez, O. (2003). A proposal for a goodness-of-fit test to the Arnason-Schwarz multisite capture-recapture model. *Biometrics*, 59(1), 43–53.
- Punt, A.E. 2017. Some insights into data weighting in integrated stock assessments. *Fisheries Research* 192: 52-65.
- Quinn, T.J., and Deriso, R.B. 1999. *Quantitative Fish Dynamics*. Oxford University Press.
- R Core Team. (2021). *R: A Language and Environment for Statistical Computing*. R Foundation for Statistical Computing. <https://www.R-project.org/>
- R Core Team. (2024). *R: A Language and Environment for Statistical Computing*. R Foundation for Statistical Computing. <https://www.R-project.org/>
- Renkas, B. J. 2010. Description of periodicity and location of red drum (*Sciaenops ocellatus*) spawning in Charleston Harbor, South Carolina. M.S. Thesis. College of Charleston, Charleston, SC.
- Reyier, E. A. and J. M. Shenker. 2007. Ichthyoplankton community structure in a shallow subtropical estuary of the Florida Atlantic Coast. *Bulletin of Marine Science* 80: 267-293.
- Reyier, E. A., R. H. Lowers, D. M. Scheidt, and D. H. Adams. 2011. Movement patterns of adult red drum, *Sciaenops ocellatus*, in shallow Florida lagoons as inferred through acoustic telemetry. *Environmental Biology of Fishes* 90: 343–360.

- Rooker, J. R. and S. A. Holt. 1997. Utilization of subtropical seagrass meadows by newly settled red drum *Sciaenops ocellatus*: Patterns of distribution and growth. Marine Ecology Progress Series 158: 139–149.
- Rooker, J.R., G.J. Holt, and S.A. Holt. 1998. Vulnerability of newly settled red drum (*Sciaenops ocellatus*) to predatory fish: is early-life survival enhanced by seagrass meadows? Marine Biology 131: 145–151.
- Rooker, J. R., S. A. Holt, G. J. Holt, and L. A. Fuiman. 1999. Spatial and temporal variability in growth, mortality, and recruitment potential of postsettlement red drum, *Sciaenops ocellatus*, in a subtropical estuary. Fishery Bulletin 97: 581–590.
- Ross, J. L. and T. M. Stevens. 1992. Life history and population dynamics of red drum (*Sciaenops ocellatus*) in North Carolina waters. Marine Fisheries Research. Completion Report, Project F-29. North Carolina Department of Marine Fisheries, Morehead City, NC.
- Ross, J. L., T. M. Stevens, and D. S. Vaughan. 1995. Age, growth, mortality, and reproductive biology of red drums in North Carolina waters. Transactions of the American Fisheries Society 124: 37-54.
- Sandercock, B. K., Murray, D., & Sandercock, B. (2020). Mark-recapture models for estimation of demographic parameters. Population Ecology in Practice, 157–190.
- Scott, R.D. and J. Heikkinen. 2012. Estimating age at first maturity in fish from change-points in growth rate. Marine Ecology Progress Series, 450:147-157.
- SEDAR (SouthEast Data, Assessment, and Review). 2009a. Stock assessment report for Atlantic red drum. Southeast Data, Assessment, and Review. North Charleston, South Carolina.
- SEDAR. 2009b. Overview of red drum tagging data and recapture results by state from Virginia to Florida. SEDAR18-DW02. SEDAR. North Charleston, SC.
- SEDAR. 2015a. SEDAR 44 – Atlantic red drum stock assessment report. SEDAR, North Charleston SC.
- SEDAR. 2015b. SEDAR procedural workshop 7: Data best practices. SEDAR, North Charleston SC.
- Setzler, E. M. 1977. A quantitative study of the movement of larval and juvenile Sciaenidae and Engraulidae into the estuarine nursery grounds of Doboy Sound, Sapelo Island, Georgia. M.S. Thesis. University of Georgia.
- SAFMC (South Atlantic Fisheries Management Council). 1998. Habitat plan for the south Atlantic region: Essential fish habitat requirements for fishery management plans of the South Atlantic Fishery Management Council. SAFMC, Charleston, SC.



- Seyoum, S., M. D. Tringali, and T. M. Bert. 2000. An analysis of genetic population structure in red drum, *Sciaenops ocellatus*, based on mtDNA control region sequences. *Fishery Bulletin* 98: 127-138.
- Shertzer, K. and P. Conn. 2012. Spawner-recruit relationships of demersal marine fishes: Prior distribution of steepness. *Bulletin of Marine Science* 88. 10.5343/bms.2011.1019.
- Simmons, E. G. and J. P. Breuer. 1962. A study of redfish, *Sciaenops ocellatus* (Linnaeus), and black drum, *Pogonias cromis* (Linnaeus). *Publications of the Institute of Marine Science* 8: 184–211.
- Stari, T., K.F. Preedy, E. McKenzie, W.S.C. Gurney, M.R. Heath, P.A. Kunzlik, & D.C. Spiers. 2010. Smooth age length keys: observations and implications for data collection on North Sea haddock. *Fish. Res.* 105(1): 2-12. <https://doi.org/10.1016/j.fishres.2010.02.004>.
- Stunz, G. W., T. J. Minello, and P. S. Levin. 2002. Growth of newly settled red drum *Sciaenops ocellatus* in different estuarine habitat types. *Marine Ecology Progress Series* 238: 227-236.
- Takade, H.M. and L.M. Paramore. 2007. Stock status of the northern red drum stock. North Carolina Division of Marine Fisheries, Morehead City.
- Then, A.Y., J.M. Hoenig, N.G. Hall, and D.A. Hewitt. 2015. Evaluating the predictive performance of empirical estimators of natural mortality rate using information on over 200 fish species. *ICES Journal of Marine Science* 72: 82–92.
- Tremain, D. M. and D. H. Adams. 1995. Seasonal variations in species diversity, abundance, and composition of fish communities in the northern Indian River Lagoon, Florida. *Bulletin of Marine Science* 57: 171–192.
- Troha, L. 2023. Estimating the tag-reporting rate and length-based selectivity of red drum (*Sciaenops ocellatus*) in South Carolina using a long-term tag-recapture study. M.S. Thesis, College of Charleston, Charleston, SC. 80 pp.
- Turner, T. F., L. R. Richardson, and J. R. Gold. 1999. Temporal genetic variation of mitochondrial DNA and the female effective population size of red drum (*Sciaenops ocellatus*) in the northern Gulf of Mexico. *Molecular Ecology* 8: 1223-1229.
- Vaughan, D. S. and T. E. Helser. 1990. Status of the red drum stock of the Atlantic coast: Stock assessment report for 1989. NOAA Technical Memorandum NMFS-SEFC-263, Beaufort Laboratory, Beaufort, NC.
- Vaughan, D. S. 1992. Status of the red drum stock of the Atlantic coast: Stock assessment report for 1991. NOAA Technical Memorandum NMFS-SEFC-297, Beaufort Laboratory, Beaufort, NC.

- Vaughan, D. S. 1993. Status of the red drum stock of the Atlantic coast: Stock assessment report for 1992. NOAA Technical Memorandum NMFS-SEFC-313, Beaufort Laboratory, Beaufort, NC.
- Vaughan, D. S. 1996. Status of the red drum stock of the Atlantic coast: Stock assessment report for 1995. NOAA Technical Memorandum NMFS-SEFC-380, Beaufort Laboratory, Beaufort, NC.
- Vaughan, D. S. and J. T. Carmichael. 2000. Analysis of Atlantic red drum: Northern and southern regions. National Oceanic and Atmospheric Administration Technical Memorandum NMFSSEFC-447.
- Vaughan, D. 2009. History of red drum assessments of the U.S. South Atlantic. SEDAR Working Paper 18-DW01.
- Venables, W.N. & B.D. Ripley. 2002. Modern Applied Statistics with S. Fourth Edition. Springer.
- Vetter, E.F. 1988. Estimation of natural mortality in fish stocks: a review. Fish. Bull. US 86, 25–43.
- Waples, R. S. 1989. A generalized approach for estimating effective population size from temporal changes in allele frequencies. Genetics 121: 379-391.
- Weinstein, M. P. 1979. Shallow marsh habitats as primary nurseries for fishes and shellfish, Cape Fear, North Carolina. Fishery Bulletin 77(2): 339–357.
- Wenner, C. A., W. A. Roumillat, J. Moran, M. B. Maddox, L. B. Daniel III, and J. W. Smith. 1990. Investigations on the life history and population dynamics of marine recreational fishes in South Carolina: Part 1. South Carolina Department of Natural Resources, Marine Resources Research Institute, Final Report Project F-37.
- Wenner, C. 1992. Red drum: Natural history and fishing techniques in South Carolina. Marine Resources Research Institute. Report No. 17.
- Wenner, C. A. 2000. Contributions to the biology of red drum *Sciaenops ocellatus*, in South Carolina. Final Report. National Marine Fisheries Service, St. Petersburg, Florida.
- Wilson, C.A. and D.L. Nieland. 1994. Reproductive biology of red drum, *Sciaenops ocellatus*, from the neritic waters of the northern Gulf of Mexico. Fishery Bulletin 92: 841-850.
- Wood, S.N. 2008. Fast stable direct fitting and smoothness selection for generalized additive models. Journal of the Royal Statistical Society (B). 70(3): 495-518.
- Wood, S.N. 2011. Fast stable restricted maximum likelihood and marginal likelihood estimation of semiparametric generalized linear models. Journal of the Royal Statistical Society (B). 73(1): 3-36.

- Wood, S.N. 2017. Generalized Additive Models: An Introduction with R (2<sup>nd</sup> edition). Chapman and Hall/CRC Press.
- Woodward, A. G. 1994. Tagging studies and population dynamics of red drum in coastal Georgia. Final Report. Georgia Department of Natural Resources, Brunswick, GA.
- Yokel, B. 1966. A contribution to the biology and distribution of the red drum, *Sciaenops ocellatus*. M.S. Thesis. University of Miami, Miami, FL.
- Zuur, A.F., E.N. Ieno, N.J. Walker, A.A. Saveliev, and G.M. Smith. 2009. Mixed effects models and extensions in ecology with R. Springer-Verlag, New York.
- Zuur, A.F., A.A. Saveliev, and E.N. Ieno. 2012. Zero inflated models and generalized linear mixed models with R. Highland Statistics Ltd. United Kingdom.

10 TABLES

Table 1. Red drum regulation timeline by jurisdiction for the northern stock.

Year	New Jersey	Delaware	Maryland	Potomac River	Virginia	North Carolina		
Pre-1960	No Regulations	No Regulations	No Regulations	No Regulations	No Regulations	No Regulations		
1960					No Regulations		No Regulations	No Regulations
1971								
1973								
1976								
1978								
1985								
1986								
1987								
1988					14" TL MLL; 2 fish >32" TL person <sup>-1</sup> day <sup>-1</sup>	14" TL MLL; 2 fish >32" TL person <sup>-1</sup> day <sup>-1</sup>	14" TL MLL	14" TL MLL; 2 fish >32" TL person <sup>-1</sup> day <sup>-1</sup>
1989								
1990	18" TL MLL; 1 fish >27" TL person <sup>-1</sup> day <sup>-1</sup>	18-27" TL slot limit; 5 fish person <sup>-1</sup> day <sup>-1</sup> with 1 fish allowed >27" TL person <sup>-1</sup> day <sup>-1</sup>	18" TL MLL; 5 fish person <sup>-1</sup> day <sup>-1</sup> with 1 fish allowed >27" TL person <sup>-1</sup> day <sup>-1</sup>	18" TL MLL; 1 fish >27" TL person <sup>-1</sup> day <sup>-1</sup>	18-27" TL slot limit; 5 fish person <sup>-1</sup> day <sup>-1</sup> with 1 fish allowed >27" TL person <sup>-1</sup> day <sup>-1</sup>	14-32" TL slot limit; 1 fish >32" TL; 5 fish person <sup>-1</sup> day <sup>-1</sup> recreational; 250,000 lb commercial cap		
1991						18-32" TL slot limit; 1 fish >32" TL; 5 fish person <sup>-1</sup> day <sup>-1</sup> recreational; 250,000 lb commercial cap		
1992						18-27" TL slot limit; 1 fish >27" TL (no sale); 5 fish person <sup>-1</sup> day <sup>-1</sup> recreational; 250,000 lb commercial cap		
1993								
1994								
1995								
1996								
1997								
1998							18-27" TL slot limit; 1 fish person <sup>-1</sup> day <sup>-1</sup> recreational; 250,000 lb commercial cap & 100 lb day <sup>-1</sup> trip limit	
1999							18-27" TL slot limit; 1 fish person <sup>-1</sup> day <sup>-1</sup> recreational; 250,000 lb commercial cap & 5 fish commercial trip limit	
2000	18-27" TL slot limit; 1 fish >27" TL person <sup>-1</sup> day <sup>-1</sup>	20-27" TL slot limit; 5 fish person <sup>-1</sup> day <sup>-1</sup>	18-27" TL recreational slot limit & 1 fish person <sup>-1</sup> day <sup>-1</sup> recreational limit; 18-25" TL commercial slot limit & 5 fish person <sup>-1</sup> day <sup>-1</sup> commercial limit	18-25" TL slot limit; 5 fish person <sup>-1</sup> day <sup>-1</sup>	18-26" TL slot limit; 3 fish person <sup>-1</sup> day <sup>-1</sup>	18-27" TL slot limit; 1 fish person <sup>-1</sup> day <sup>-1</sup> recreational; 250,000 lb commercial cap & 0-10 fish commercial trip limit (set by commission proclamation) with red drum not exceeding 50% total marketable catch (excluding menhaden)		
2001								
2002								
2003								
2004								
2005								
2006								
2007								
2008								
2009								
2010	18-26" TL recreational slot limit & 3 fish person <sup>-1</sup> day <sup>-1</sup> recreational limit; 18-25" TL commercial slot limit & 5 fish person <sup>-1</sup> day <sup>-1</sup> commercial limit							
2011								
2012								
2013								
2014								
2015								
2016								
2017								
2018								
2019								
2020								
2021								
2022								

**Table 2. Red drum regulation timeline by jurisdiction for the southern stock.**

Year	South Carolina	Georgia	Florida	
Pre-1925	No Regulations	No Regulations	No commercial use by out of state citizens	
1925			12" FL MLL	
1953			15" FL MLL	
1955			12" FL MLL	
1960			12" TL MLL	
1971			12" FL MLL	
1973			18" TL MLL; 1 fish >32" TL; protected species <sup>a</sup>	
1976			18" TL MLL; 1 fish >32" TL; March-April closure <sup>b</sup>	
1978			Moratorium	
1985			14" TL MLL; 20 fish person <sup>-1</sup> day <sup>-1</sup> & 1 fish >32" person <sup>-1</sup> day <sup>-1</sup> ; commercial harvest prohibited	14" TL MLL; 2 fish >32" TL person <sup>-1</sup> day <sup>-1</sup>
1986	14" TL MLL from June 1-Sept. 1; 1 fish >32" person <sup>-1</sup> day <sup>-1</sup>	14" TL MLL; 2 fish >32" TL person <sup>-1</sup> day <sup>-1</sup>	Moratorium	
1987	14" TL MLL from June 1-Sept. 1; 1 fish >32" person <sup>-1</sup> day <sup>-1</sup> ; commercial harvest prohibited		14" TL MLL; 20 fish person <sup>-1</sup> day <sup>-1</sup> & 1 fish >32" person <sup>-1</sup> day <sup>-1</sup> ; commercial harvest prohibited	18" TL MLL; 1 fish >32" TL; March-April closure <sup>b</sup>
1988	14" TL MLL; 20 fish person <sup>-1</sup> day <sup>-1</sup> & 1 fish >32" person <sup>-1</sup> day <sup>-1</sup> ; commercial harvest prohibited	14" TL MLL; 2 fish >32" TL person <sup>-1</sup> day <sup>-1</sup> ; 10 fish person <sup>-1</sup> day <sup>-1</sup>	18" TL MLL; 1 fish >32" TL; March-April closure <sup>b</sup>	
1989	14" TL MLL; 20 fish person <sup>-1</sup> day <sup>-1</sup> & 1 fish >32" person <sup>-1</sup> day <sup>-1</sup> ; commercial harvest prohibited		14" TL MLL; 5 fish person <sup>-1</sup> day <sup>-1</sup> & 1 fish >32" person <sup>-1</sup> day <sup>-1</sup> ; commercial harvest prohibited	Moratorium
1990	14" TL MLL; 20 fish person <sup>-1</sup> day <sup>-1</sup> & 1 fish >32" person <sup>-1</sup> day <sup>-1</sup> ; commercial harvest prohibited	14" TL MLL; 5 fish person <sup>-1</sup> day <sup>-1</sup>	18" TL MLL; 1 fish >32" TL; March-April closure <sup>b</sup>	
1991	14" TL MLL; 5 fish person <sup>-1</sup> day <sup>-1</sup> & 1 fish >32" person <sup>-1</sup> day <sup>-1</sup> ; commercial harvest prohibited		14" TL MLL; 20 fish person <sup>-1</sup> day <sup>-1</sup> & 1 fish >32" person <sup>-1</sup> day <sup>-1</sup> ; commercial harvest prohibited	18-27" TL slot limit; March-May closed season; 1 fish person <sup>-1</sup> day <sup>-1</sup> ; prohibition on sale <sup>c</sup>
1992	14" TL MLL; 5 fish person <sup>-1</sup> day <sup>-1</sup> & 1 fish >32" person <sup>-1</sup> day <sup>-1</sup> ; commercial harvest prohibited	14-27" TL slot limit; 5 fish person <sup>-1</sup> day <sup>-1</sup>	18-27" TL slot limit; March-May closed season; 1 fish person <sup>-1</sup> day <sup>-1</sup> ; prohibition on sale <sup>c</sup>	
1993	14-27" TL slot limit; 5 fish person <sup>-1</sup> day <sup>-1</sup> ; commercial harvest prohibited		14-27" TL slot limit; 5 fish person <sup>-1</sup> day <sup>-1</sup>	18-27" TL slot limit; 1 fish person <sup>-1</sup> day <sup>-1</sup> ; prohibition on sale
1994				
1995				
1996				
1997				
1998				
1999	15-24" TL slot limit; 2 fish person <sup>-1</sup> day <sup>-1</sup> ; commercial harvest prohibited		14-23" TL slot limit; 5 fish person <sup>-1</sup> day <sup>-1</sup>	18-27" TL slot limit; 1 fish person <sup>-1</sup> day <sup>-1</sup> ; prohibition on sale
2000				
2001				
2002				
2003	15-23" TL slot limit; 3 fish person <sup>-1</sup> day <sup>-1</sup> ; commercial harvest prohibited	14-23" TL slot limit; 5 fish person <sup>-1</sup> day <sup>-1</sup>	18-27" TL slot limit; 1 fish person <sup>-1</sup> day <sup>-1</sup> ; prohibition on sale	
2004				
2005				
2006				
2007				
2008				
2009	14-23" TL slot limit; 5 fish person <sup>-1</sup> day <sup>-1</sup> ; commercial sale prohibited	14-23" TL slot limit; 5 fish person <sup>-1</sup> day <sup>-1</sup> ; commercial sale prohibited	18-27" TL slot limit; 2 fish person <sup>-1</sup> day <sup>-1</sup> in NE (Atlantic) and NW (Gulf) regions; 1 fish person <sup>-1</sup> day <sup>-1</sup> for south region; prohibition on sale	
2010				
2011				
2012				
2013	15-23" TL slot limit; 2 fish person <sup>-1</sup> day <sup>-1</sup> & 6 fish boat <sup>-1</sup> day <sup>-1</sup> ; commercial harvest prohibited	14-23" TL slot limit; 5 fish person <sup>-1</sup> day <sup>-1</sup> ; commercial sale prohibited	18-27" TL slot limit; 1 fish person <sup>-1</sup> day <sup>-1</sup> & 4 fish vessel limit in NE region; 0 fish person <sup>-1</sup> day <sup>-1</sup> & 0 fish vessel limit in Indian River Lagoon region; 1 fish person <sup>-1</sup> day <sup>-1</sup> & 2 fish vessel limit in SE region; prohibition on sale	
2014				
2015				
2016				
2017	15-23" TL slot limit; 2 fish person <sup>-1</sup> day <sup>-1</sup> & 6 fish boat <sup>-1</sup> day <sup>-1</sup> ; commercial harvest prohibited	14-23" TL slot limit; 5 fish person <sup>-1</sup> day <sup>-1</sup> ; commercial sale prohibited	18-27" TL slot limit; 1 fish person <sup>-1</sup> day <sup>-1</sup> & 4 fish vessel limit in NE region; 0 fish person <sup>-1</sup> day <sup>-1</sup> & 0 fish vessel limit in Indian River Lagoon region; 1 fish person <sup>-1</sup> day <sup>-1</sup> & 2 fish vessel limit in SE region; prohibition on sale	
2018				
2019	15-23" TL slot limit; 2 fish person <sup>-1</sup> day <sup>-1</sup> & 6 fish boat <sup>-1</sup> day <sup>-1</sup> ; commercial harvest prohibited	14-23" TL slot limit; 5 fish person <sup>-1</sup> day <sup>-1</sup> ; commercial sale prohibited	18-27" TL slot limit; 1 fish person <sup>-1</sup> day <sup>-1</sup> & 4 fish vessel limit in NE region; 0 fish person <sup>-1</sup> day <sup>-1</sup> & 0 fish vessel limit in Indian River Lagoon region; 1 fish person <sup>-1</sup> day <sup>-1</sup> & 2 fish vessel limit in SE region; prohibition on sale	
2020				
2021	15-23" TL slot limit; 2 fish person <sup>-1</sup> day <sup>-1</sup> & 6 fish boat <sup>-1</sup> day <sup>-1</sup> ; commercial harvest prohibited	14-23" TL slot limit; 5 fish person <sup>-1</sup> day <sup>-1</sup> ; commercial sale prohibited	18-27" TL slot limit; 1 fish person <sup>-1</sup> day <sup>-1</sup> & 4 fish vessel limit in NE region; 0 fish person <sup>-1</sup> day <sup>-1</sup> & 0 fish vessel limit in Indian River Lagoon region; 1 fish person <sup>-1</sup> day <sup>-1</sup> & 2 fish vessel limit in SE region; prohibition on sale	
2022				

a - harvest moratorium from 11/7/86-2/17/1987

b - harvest moratorium from 5/1-10/1/1987; reopened 10/1/1987 with 18-27" TL slot limit, 5 fish commercial possession limit & 1 fish recreational possession limit

c - prohibited gigging and spearing on 6/3/1991 (still in effect)

**Table 3. Von Bertalanffy growth parameters estimated for red drum captured in North Carolina from north of the White Oak River (North), within and south of the White Oak River (South), and all individuals combined (Pooled).**

<b>Parameter</b>	<b>North</b>	<b>South</b>	<b>Pooled</b>
<i>L<sub>inf</sub></i>	1165	1066	1165
<i>K</i>	0.22	0.32	0.23
<i>t<sub>0</sub></i>	-0.739	-0.217	-0.755

**Table 4. Von Bertalanffy growth parameters estimated for red drum captured in North Carolina from within and south of the White Oak River (south), South Carolina (SC), and all individuals combined (Pooled).**

<b>Parameter</b>	<b>South</b>	<b>SC</b>	<b>Pooled</b>
<i>L<sub>inf</sub></i>	1066	1030	1030
<i>K</i>	0.316	0.249	0.249
<i>t<sub>0</sub></i>	-0.217	-0.505	-0.513



**Table 6. Number of red drum age samples collected by state within the Atlantic coast of the U.S. from 1981 – 2022. The variable ‘MULTI’ refers to several fishery independent surveys (e.g., ChesMMAP, NEAMAP) whose sampling universe spans multiple states; they operate in the northern stock.**

Year	Age (yrs)						Total
	FL	GA	SC	NC	VA	MULTI	
1981	312	0	0	0	0	0	312
1982	187	0	0	0	0	0	187
1984	0	0	1	0	0	0	1
1985	0	0	140	0	0	0	140
1986	0	0	943	0	0	0	943
1987	0	0	393	142	0	0	535
1988	0	0	305	367	0	0	672
1989	0	0	614	452	0	0	1066
1990	0	0	820	575	0	0	1395
1991	0	0	673	1970	0	0	2643
1992	0	0	357	938	0	0	1295
1993	0	0	518	1748	0	0	2266
1994	0	0	391	725	0	0	1116
1995	0	0	317	996	0	0	1313
1996	0	13	453	638	0	0	1104
1997	0	345	340	1615	0	0	2300
1998	0	334	317	1600	43	0	2294
1999	0	237	196	656	92	0	1181
2000	41	141	1089	933	53	0	2257
2001	108	197	749	417	30	0	1501
2002	96	633	926	613	29	0	2297
2003	117	462	460	755	26	0	1820
2004	131	215	403	2203	1	0	2953
2005	155	345	330	1760	25	0	2615
2006	172	154	579	1085	52	7	2049
2007	143	291	590	1052	74	1	2151
2008	97	15	864	1038	127	0	2141
2009	116	0	951	717	56	6	1846
2010	113	0	705	1093	19	5	1935
2011	171	0	606	1301	9	9	2096
2012	174	0	540	1297	71	8	2090
2013	281	81	407	822	133	5	1729
2014	242	241	381	874	63	8	1809
2015	166	270	637	1380	6	5	2464
2016	188	343	623	2096	53	6	3309
2017	179	448	699	1556	53	9	2944
2018	166	452	489	2616	12	0	3735
2019	109	469	252	2169	46	0	3045
2020	113	352	424	636	109	0	1634
2021	221	203	335	755	114	12	1640
2022	66	0	132	295	34	5	532
Total	3864	6241	19949	39885	1330	86	71355
Percent	0.054	0.087	0.280	0.559	0.019	0.001	



**Table 7. Number of red drum age samples collected by fishery dependent and fishery independent sources on the Atlantic coast of the U.S. from 1981 – 2022.**

Year	Fishery Dependent	Fishery Independent
1981	312	0
1982	187	0
1984	0	1
1985	0	140
1986	81	862
1987	148	387
1988	265	407
1989	343	723
1990	290	1105
1991	376	2267
1992	518	777
1993	363	1903
1994	239	877
1995	554	759
1996	463	641
1997	1010	1290
1998	958	1335
1999	717	464
2000	711	1544
2001	497	1004
2002	732	1563
2003	499	1320
2004	445	2508
2005	741	1874
2006	554	1495
2007	428	1723
2008	235	1868
2009	157	1689
2010	144	1791
2011	114	1982
2012	202	1888
2013	333	1396
2014	363	1446
2015	337	2127
2016	519	2790
2017	663	2265
2018	618	3117
2019	695	2350
2020	801	833
2021	592	1048
2022	143	389
Total	17347	53948
Percent	0.243	0.757

**Table 8. Length-at-maturity as estimated using logistic regressions fit to histologically derived maturity status information from South Carolina (SCDNR) and North Carolina (Ross et al. 1995 and NCDMF Study). Total lengths were measured to the nearest mm TL. As data was only available from one state in each stock (South Carolina = Southern; North Carolina = Northern), these analyses represent maturity ogives for the respective stock. Parameters a and b ( $\pm$ SE) are for the logistic function  $Prop. Mat. = e^Z / (1 + e^Z)$  where  $Z = a + b * TL$ . 50% maturity represents the total length where proportion mature equals 0.5 with 95% CI of estimate in parentheses. Also provided are the maturity ogives and 50% maturities as presented in SEDAR 44 for reference.**

Sex	Stock	n	a	$\pm$ SE	b	$\pm$ SE	50% maturity	Source
Female	Southern	1805	-17.893	1.1302	0.022806	0.0014545	784.6	SEDAR 44*
	Northern	305	-38.840	7.3701	0.044512	0.0085605	872.6	SEDAR 44*
	Southern	1132	-16.282	1.0945	0.021265	0.0013822	766 (753 - 778)	Current Study
	Northern	435	-28.824	4.1943	0.034490	0.0050720	836 (818 - 853)	Current Study
Male	Southern	2927	-18.379	1.1419	0.026493	0.0016986	693.7	SEDAR 44*
	Northern	340	-19.801	3.7656	0.029440	0.0054736	672.6	SEDAR 44*
	Southern	941	-10.008	0.6711	0.014865	0.0009597	673 (658 - 688)	Current Study
	Northern	340	-17.266	3.0748	0.027354	0.0047262	631 (611 - 651)	Current Study

\* - Calculations assumed a Jan 1 birth date

**Table 9. Age-at-maturity as estimated using logistic regressions fit to histologically derived maturity status information from South Carolina (SCDNR) and North Carolina (Ross et al. 1995 and NCDMF Study). Ages (in yrs) fit were age to the nearest month, assuming a September 1 birthday. As data was only available from one state in each stock (South Carolina = Southern; North Carolina = Northern), these analyses represent maturity ogives for the respective stock. Parameters a and b ( $\pm$ SE) are for the logistic function  $Prop. Mat. = e^Z / (1 + e^Z)$  where  $Z = a + b * Age$ . 50% maturity represents the age where proportion mature equals 0.5 with 95% CI of estimate in parentheses. Also provided are the maturity ogives and 50% maturities as presented in SEDAR 44 for reference.**

Sex	Stock	n	a	$\pm$ SE	b	$\pm$ SE	50% maturity	Source
Female	Southern	2613	-9.075	0.4540	1.792	0.1074	5.1	SEDAR 44*
	Northern	334	-29.874	6.0502	7.276	1.5721	4.1	SEDAR 44*
	Southern	1119	-6.539	0.4999	1.546	0.1292	4.2 (4.0 - 4.4)	Current Study
	Northern	398	-15.165	2.2199	4.281	0.6650	3.5 (3.4 - 3.7)	Current Study
Male	Southern	2930	-10.122	0.4524	2.427	0.1250	4.2	SEDAR 44*
	Northern	318	-10.815	1.8889	3.666	0.6153	2.9	SEDAR 44*
	Southern	938	-4.068	0.3442	1.207	0.1079	3.4 (3.2 - 3.6)	Current Study
	Northern	318	-8.372	1.4670	3.748	0.6237	2.2 (2.1 - 2.4)	Current Study

\* - Calculations assumed a Jan 1 birth date

**Table 10. Predicted proportion mature by 20 mm TL bin for the southern and northern stock as estimated in SEDAR44 and the current assessment for female red drum.**

Total Length	Southern		Northern	
	SEDAR 44	Current	SEDAR 44	Current
<300	0.00	0.00		
300	0.00	0.01		
320	0.00	0.01		
340	0.00	0.01		
360	0.01	0.02		
380	0.01	0.03		
400	0.02	0.04	0.00	0.00
420	0.02	0.06	0.00	0.00
440	0.04	0.10	0.00	0.00
460	0.06	0.15	0.00	0.00
480	0.10	0.23	0.00	0.00
500	0.15	0.35	0.00	0.00
520	0.24	0.54	0.00	0.00
540	0.38	0.82	0.00	0.00
560	0.59	1.24	0.00	0.01
580	0.93	1.89	0.00	0.01
600	1.46	2.87	0.00	0.03
620	2.29	4.32	0.00	0.06
640	3.57	6.46	0.00	0.12
660	5.51	9.56	0.10	0.23
680	8.43	13.92	0.02	0.46
700	12.69	19.84	0.05	0.92
720	18.65	27.46	0.11	1.81
740	26.57	36.68	0.27	3.55
760	36.34	46.99	0.66	6.84
780	47.39	57.56	1.60	12.77
800	58.71	67.48	3.80	22.58
820	69.17	76.05	8.79	36.77
840	77.97	82.93	19.00	53.68
860	84.81	88.14	36.36	69.79
880	89.81	91.92	58.19	82.16
900	93.29	94.57	77.22	90.18
920	95.64	96.38	89.20	94.82
940	97.19	97.60	95.26	97.33
960	98.20	98.42	98.00	98.64
980	98.85	98.96	99.17	99.31
1000	99.27	99.32	99.66	99.66
1020	99.54	99.55	99.86	99.83
1040	99.71	99.71	99.94	99.91
1060	99.81	99.81	99.98	99.96
1080	99.88	99.88	99.99	99.98
1100	99.92	99.92	100.00	99.99
1120	99.95	99.95	100.00	99.99
1140	99.97	99.97	100.00	100.00
1160	99.98	99.98	100.00	100.00
1180	99.99	99.99	100.00	100.00
≥1200			100.00	100.00

**Table 11. Predicted proportion mature by age for the southern and northern stock as estimated in SEDAR44 and the current assessment for female red drum. Note, this is proportion mature on a given birthday, which was assumed to be January 1 in SEDAR 44 and September 1 in the current assessment. This, along with the new data, led to a higher percentage of younger age red drum being mature in the current assessment.**

Age	Southern		Northern	
	SEDAR 44	Current	SEDAR 44	Current
0	0.01	0.14	0.00	0.00
1	0.70	0.67	0.00	0.00
2	0.41	3.09	0.00	0.14
3	2.42	13.00	0.03	8.93
4	12.93	41.22	31.65	87.64
5	47.13	76.69	99.85	99.81
6	84.25	93.92	100.00	100.00
7	96.98	98.64	100.00	100.00
8	99.48	99.71	100.00	100.00
9	99.91	99.94	100.00	100.00
10	99.99	99.99	100.00	100.00
11	100.00	100.00	100.00	100.00
12	100.00	100.00	100.00	100.00
13	100.00	100.00	100.00	100.00
14	100.00	100.00	100.00	100.00
15+	100.00	100.00	100.00	100.00

**Table 12. Number of actively spawning and mature females observed by SCDNR from mid-August through September and resultant probability of spawning, spawning frequency, and # of spawns assuming a 45-day spawning season for individual fish. Data was analyzed using only females captured in August, in September, and August and September combined.**

Month	Actively Spawning	Mature	Probability Spawning	Spawning Frequency (Days)	# of Spawns
August	7	29	0.2414	4	10.9
September	18	55	0.3273	3	14.7
August + September	25	84	0.2976	3	13.4

**Table 13. Correlation results for North Carolina Bag Seine Survey recruitment index and favorable wind indices from North Carolina State Climate Office station KHSE. Significant results (p-value<0.05) are bolded and italicized.**

Years	Period	r	p-value
1991-2022	Late July	0.01	0.968
1991-2022	Early August	0.22	0.228
1991-2016	Late August	0.45	<b><i>0.022</i></b>
1991-2022	Late August	0.32	0.072
1991-2022	August	0.31	0.085
1991-2022	Early September	0.19	0.293
1991-2022	Late September	-0.09	0.622
1991-2022	September	0.10	0.597
1991-2016	Early October	0.41	<b><i>0.039</i></b>
1991-2022	Early October	0.40	<b><i>0.022</i></b>
1991-2016	Seasonal	0.41	<b><i>0.036</i></b>
1991-2022	Seasonal	0.37	<b><i>0.039</i></b>

**Table 14. Correlation results for North Carolina Bag Seine Survey recruitment index and sea surface temperature indices from NOAA National Data Buoy Center Stations DSLN7 and 41025.**

Years	Period	r	p-value
1991-2016	Late July	0.24	0.240
1991-2022	Late July	0.20	0.267
1991-2022	Early August	0.09	0.626
1991-2022	Late August	-0.09	0.628
1991-2022	August	0.00	0.981
1991-2022	Early September	-0.11	0.550
1991-2022	Late September	0.02	0.900
1991-2022	Early October	0.02	0.919
1991-2022	September	-0.05	0.784
1991-2022	Seasonal	0.03	0.888

**Table 15. Correlation results for southern stock recruitment indices and favorable wind indices from NOAA National Data Buoy Center Stations 41004 (southeast of Charleston) and 41008 (southeast of Savannah). Significant results (p-value<0.05) are bolded and italicized.**

JAI	Buoy	Period	r	p-value
SC	41004	Early September	0.63	<b><i>0.007</i></b>
GA	41008	Early August	0.47	0.051
SC	41004	Early October	0.49	0.054
GA	41008	September	0.43	0.076
GA	41004	Late August	-0.48	0.085
GA	41008	Late September	0.42	0.096

**Table 16. Natural mortality-at-age,  $M(a)$ , or -weight,  $M(w)$ , of red drum in the northern ( $t_{max} = 62$ ) and southern ( $t_{max} = 41$ ) stocks. The ‘Mortality-weight’ model ( $M_w$ ) followed Lorenzen (1996). The ‘Length-inverse’ estimates of  $M_l$  followed Lorenzen (2022) using the Hamel and Cope (2022) constant  $M$  estimate. The ‘Length-inverse’ model scaled the cumulative mortality rate predicted for ages 2 – 62 and ages 2-41 to the longevity-based constant  $M$  estimates for the northern and southern stocks, respectively.**

Age (yr)	Length (mm)	Northern Stock		Length (mm)	Southern Stock	
		Lorenzen (1996)	Lorenzen (2022)		Lorenzen (1996)	Lorenzen (2022)
		$M_w$	$M_a$		$M_w$	$M_a$
0.5	195	0.349	0.498	165	0.517	0.749
1.5	436	0.177	0.223	383	0.25	0.322
2.5	615	0.132	0.158	528	0.19	0.233
3.5	748	0.112	0.13	646	0.16	0.191
4.5	854	0.1	0.114	740	0.142	0.167
5.5	938	0.092	0.103	816	0.131	0.151
6.5	979	0.089	0.099	854	0.125	0.144
7.5	991	0.088	0.098	866	0.124	0.142
8.5	1003	0.087	0.097	876	0.123	0.141
9.5	1015	0.087	0.096	887	0.122	0.139
10.5	1025	0.086	0.095	897	0.12	0.137
11.5	1036	0.085	0.094	906	0.119	0.136
12.5	1045	0.084	0.093	915	0.118	0.135
13.5	1055	0.084	0.092	924	0.117	0.133
14.5	1064	0.083	0.091	933	0.116	0.132
15.5	1072	0.083	0.09	941	0.116	0.131
16.5	1080	0.082	0.09	949	0.115	0.13
17.5	1088	0.082	0.089	956	0.114	0.129
18.5	1096	0.081	0.089	963	0.113	0.128
19.5	1103	0.081	0.088	970	0.113	0.127
20.5	1110	0.08	0.087	977	0.112	0.126
21.5	1116	0.08	0.087	983	0.111	0.125
22.5	1122	0.079	0.086	989	0.111	0.125
23.5	1128	0.079	0.086	995	0.11	0.124
24.5	1134	0.079	0.086	1000	0.11	0.123
25.5	1139	0.078	0.085	1006	0.109	0.123
26.5	1144	0.078	0.085	1011	0.109	0.122
27.5	1149	0.078	0.084	1016	0.108	0.121
28.5	1154	0.078	0.084	1021	0.108	0.121
29.5	1158	0.077	0.084	1025	0.107	0.12
30.5	1163	0.077	0.083	1029	0.107	0.12
31.5	1167	0.077	0.083	1034	0.107	0.119
32.5	1171	0.077	0.083	1038	0.106	0.119
33.5	1174	0.076	0.083	1041	0.106	0.118
34.5	1178	0.076	0.082	1045	0.106	0.118

Age (yr)	Length (mm)	Northern Stock		Length (mm)	Southern Stock	
		Lorenzen (1996)	Lorenzen (2022)		Lorenzen (1996)	Lorenzen (2022)
		M <sub>w</sub>	M <sub>a</sub>		M <sub>w</sub>	M <sub>a</sub>
35.5	1181	0.076	0.082	1049	0.105	0.118
36.5	1185	0.076	0.082	1052	0.105	0.117
37.5	1188	0.076	0.082	1055	0.105	0.117
38.5	1191	0.076	0.081	1058	0.104	0.117
39.5	1193	0.075	0.081	1061	0.104	0.116
40.5	1196	0.075	0.081	1064	0.104	0.116
41				1066	0.104	0.116
41.5	1199	0.075	0.081			
42.5	1201	0.075	0.081			
43.5	1203	0.075	0.081			
44.5	1206	0.075	0.08			
45.5	1208	0.075	0.08			
46.5	1210	0.075	0.08			
47.5	1212	0.074	0.08			
48.5	1214	0.074	0.08			
49.5	1215	0.074	0.08			
50.5	1217	0.074	0.08			
51.5	1219	0.074	0.08			
52.5	1220	0.074	0.079			
53.5	1222	0.074	0.079			
54.5	1223	0.074	0.079			
55.5	1225	0.074	0.079			
56.5	1226	0.074	0.079			
57.5	1227	0.074	0.079			
58.5	1228	0.074	0.079			
59.5	1229	0.074	0.079			
60.5	1230	0.074	0.079			
61.5	1231	0.073	0.079			
62	1232	0.073	0.079			



**Table 17. Commercial gear categories developed and used in past red drum SEDAR stock assessments for ACCSP gear codes.**

ACCSP Gear Code	ACCSP Gear Name	ACCSP Category Name	ACCSP Type Name	SEDAR Gear
20	OTHER SEINES	OTHER SEINES	HAUL SEINES	Beach Seine
60	FYKE NETS	FYKE NETS	FIXED NETS	Beach Seine
76	STOP NET	OTHER FIXED NETS	FIXED NETS	Beach Seine
130	POTS AND TRAPS	POTS AND TRAPS	POTS AND TRAPS	Gill Nets
131	POTS AND TRAPS, CONCH	POTS AND TRAPS	POTS AND TRAPS	Gill Nets
132	POTS AND TRAPS, BLUE CRAB	POTS AND TRAPS	POTS AND TRAPS	Gill Nets
136	POTS AND TRAPS, CRAB, PEELER	POTS AND TRAPS	POTS AND TRAPS	Gill Nets
137	POTS AND TRAPS, CRAYFISH	POTS AND TRAPS	POTS AND TRAPS	Gill Nets
138	POTS AND TRAPS, EEL	POTS AND TRAPS	POTS AND TRAPS	Gill Nets
139	POTS AND TRAPS, FISH	POTS AND TRAPS	POTS AND TRAPS	Gill Nets
140	POTS AND TRAPS, SPINY LOBSTER	POTS AND TRAPS	POTS AND TRAPS	Gill Nets
141	POTS AND TRAPS, OCTOPUS	POTS AND TRAPS	POTS AND TRAPS	Gill Nets
142	POTS AND TRAPS, PERIWINKLE OR CONKLE	POTS AND TRAPS	POTS AND TRAPS	Gill Nets
143	POTS AND TRAPS, SHRIMP	POTS AND TRAPS	POTS AND TRAPS	Gill Nets
144	POTS AND TRAPS, TURTLE	POTS AND TRAPS	POTS AND TRAPS	Gill Nets
145	POTS AND TRAPS, STONE CRAB	POTS AND TRAPS	POTS AND TRAPS	Gill Nets
146	POTS AND TRAPS, SCUP	POTS AND TRAPS	POTS AND TRAPS	Gill Nets
147	POTS AND TRAPS, BLACK SEA BASS	POTS AND TRAPS	POTS AND TRAPS	Gill Nets
148	POTS AND TRAPS, REEF FISH	POTS AND TRAPS	POTS AND TRAPS	Gill Nets
149	POTS AND TRAPS, HAGFISH	POTS AND TRAPS	POTS AND TRAPS	Gill Nets
150	POTS AND TRAPS, GOLDEN CRAB	POTS AND TRAPS	POTS AND TRAPS	Gill Nets
151	POTS AND TRAPS, PUFFER	POTS AND TRAPS	POTS AND TRAPS	Gill Nets
152	POTS, CRAB OTHER	POTS AND TRAPS	POTS AND TRAPS	Gill Nets
153	POTS AND TRAPS, MINNOW	POTS AND TRAPS	POTS AND TRAPS	Gill Nets
160	POTS AND TRAPS, LOBSTER	POTS & TRAPS, LOBSTER	POTS AND TRAPS	Gill Nets
161	POTS AND TRAPS, LOBSTER INSHORE	POTS & TRAPS, LOBSTER	POTS AND TRAPS	Gill Nets
162	POTS AND TRAPS, LOBSTER OFFSHORE	POTS & TRAPS, LOBSTER	POTS AND TRAPS	Gill Nets
163	POTS AND TRAPS, LOBSTER DOUBLE PARLOR	POTS & TRAPS, LOBSTER	POTS AND TRAPS	Gill Nets
164	POTS AND TRAPS, COLLAPSIBLE CRAB	POTS AND TRAPS	POTS AND TRAPS	Gill Nets
180	POTS AND TRAPS, OTHER	POTS & TRAPS, OTHER	POTS AND TRAPS	Gill Nets
181	POTS, UNCLASSIFIED	POTS & TRAPS, OTHER	POTS AND TRAPS	Gill Nets
200	GILL NETS	GILL NETS	GILL NETS	Gill Nets
201	GILL NETS, FLOATING DRIFT	GILL NETS	GILL NETS	Gill Nets
202	GILL NETS, SINK DRIFT	GILL NETS	GILL NETS	Gill Nets
203	GILL NETS, FLOATING ANCHOR	GILL NETS	GILL NETS	Gill Nets
204	GILL NETS, SINK ANCHOR	GILL NETS	GILL NETS	Gill Nets
205	GILL NETS, RUNAROUND	GILL NETS	GILL NETS	Gill Nets
206	GILL NETS, STAKE	GILL NETS	GILL NETS	Gill Nets
207	GILL NETS, OTHER	GILL NETS	GILL NETS	Gill Nets
208	GILL NETS, DRIFT, SMALL MESH	GILL NETS	GILL NETS	Gill Nets
209	GILL NETS, DRIFT, LARGE MESH	GILL NETS	GILL NETS	Gill Nets
210	TRAMMEL NETS	TRAMMEL NETS	GILL NETS	Gill Nets
211	TRAMMEL NETS, FLOATING DRIFT	TRAMMEL NETS	GILL NETS	Gill Nets
212	TRAMMEL NETS, SINK DRIFT	TRAMMEL NETS	GILL NETS	Gill Nets
213	TRAMMEL NETS, FLOATING ANCHOR	TRAMMEL NETS	GILL NETS	Gill Nets
214	TRAMMEL NETS, SINK ANCHOR	TRAMMEL NETS	GILL NETS	Gill Nets
215	TRAMMEL NETS, RUNAROUND	TRAMMEL NETS	GILL NETS	Gill Nets
216	TRAMMEL NETS, OTHER	TRAMMEL NETS	GILL NETS	Gill Nets
300	HOOK AND LINE	HOOK AND LINE	HOOK AND LINE	Hook and Line
301	HOOK AND LINE, MANUAL	HOOK AND LINE	HOOK AND LINE	Hook and Line
302	HOOK AND LINE, ELECTRIC	HOOK AND LINE	HOOK AND LINE	Hook and Line
303	ELECTRIC/HYDRAULIC, BANDIT REELS	HOOK AND LINE	HOOK AND LINE	Hook and Line
304	HOOK AND LINE, CHUM	HOOK AND LINE	HOOK AND LINE	Hook and Line
305	HOOK AND LINE, JIG	HOOK AND LINE	HOOK AND LINE	Hook and Line
306	HOOK AND LINE, TROLL	HOOK AND LINE	HOOK AND LINE	Hook and Line
307	HOOK AND LINE, CAST	HOOK AND LINE	HOOK AND LINE	Hook and Line
308	HOOK AND LINE, DRIFTING EEL	HOOK AND LINE	HOOK AND LINE	Hook and Line
309	HOOK AND LINE, FLY	HOOK AND LINE	HOOK AND LINE	Hook and Line
310	HOOK AND LINE, BOTTOM	HOOK AND LINE	HOOK AND LINE	Hook and Line
320	TROLL LINES	TROLL LINES	HOOK AND LINE	Hook and Line
321	TROLL LINE, MANUAL	TROLL LINES	HOOK AND LINE	Hook and Line
322	TROLL LINE, ELECTRIC	TROLL LINES	HOOK AND LINE	Hook and Line
323	TROLL LINE, HYDRAULIC	TROLL LINES	HOOK AND LINE	Hook and Line
324	TROLL LINE, GREEN-STICK	TROLL LINES	HOOK AND LINE	Hook and Line
330	HAND LINE	HAND LINE	HAND LINE	Hook and Line
331	TROLL & HAND LINE CMB	HAND LINE	HAND LINE	Hook and Line
340	AUTO JIG	HAND LINE	HAND LINE	Hook and Line
400	LONG LINES	LONG LINES	LONG LINES	Hook and Line
401	LONG LINES, VERTICAL	LONG LINES	LONG LINES	Hook and Line
402	LONG LINES, SURFACE	LONG LINES	LONG LINES	Hook and Line
403	LONG LINES, BOTTOM	LONG LINES	LONG LINES	Hook and Line
404	LONG LINES, SURFACE, MIDWATER	LONG LINES	LONG LINES	Hook and Line
405	LONG LINES, TROT	LONG LINES	LONG LINES	Hook and Line
406	LONG LINES, TURTLE HOOKS	LONG LINES	LONG LINES	Hook and Line
407	LONG LINES, DRIFT W/HOOKS	LONG LINES	LONG LINES	Hook and Line

Table 17. (cont.)

ACCSP Gear Code	ACCSP Gear Name	ACCSP Category Name	ACCSP Type Name	SEDAR Gear
408	BUOY GEAR	LONG LINES	LONG LINES	Hook and Line
409	LONG LINE, PELAGIC	LONG LINES	LONG LINES	Hook and Line
660	SPEARS	SPEARS	SPEARS AND GIGS	Hook and Line
661	SPEARS, DIVING	SPEARS	SPEARS AND GIGS	Hook and Line
662	GIGS	SPEARS	SPEARS AND GIGS	Hook and Line
700	HAND LINE	HAND LINE	HAND LINE	Hook and Line
701	TROLL AND HAND LINES CMB	HAND LINE	HAND LINE	Hook and Line
0	NOT CODED	NOT CODED	NOT CODED	OTHER
40	LAMPARA/RING NETS	LAMPARA/RING NETS	PURSE SEINES	OTHER
70	OTHER FIXED NETS	OTHER FIXED NETS	FIXED NETS	OTHER
71	WEIRS	OTHER FIXED NETS	FIXED NETS	OTHER
72	TRAP NETS	OTHER FIXED NETS	FIXED NETS	OTHER
73	FLOATING TRAPS (SHALLOW)	OTHER FIXED NETS	FIXED NETS	OTHER
74	BAG NETS	OTHER FIXED NETS	FIXED NETS	OTHER
75	CHANNEL NETS	OTHER FIXED NETS	FIXED NETS	OTHER
77	HOOP NET	OTHER FIXED NETS	FIXED NETS	OTHER
78	BANK TRAP, CHANNEL POUND	OTHER FIXED NETS	FIXED NETS	OTHER
182	BOX TRAPS	POTS & TRAPS, OTHER	POTS AND TRAPS	OTHER
183	WIRE BASKETS	POTS & TRAPS, OTHER	POTS AND TRAPS	OTHER
184	SLAT TRAPS (VIRGINIA)	POTS & TRAPS, OTHER	POTS AND TRAPS	OTHER
500	DREDGE	DREDGE	DREDGE	OTHER
501	DREDGE, HYDRAULIC, CLAM	DREDGE	DREDGE	OTHER
502	DREDGE, HYDRAULIC ESCALATOR, CLAM	DREDGE	DREDGE	OTHER
503	DREDGE, CLAM	DREDGE	DREDGE	OTHER
504	DREDGE, URCHIN	DREDGE	DREDGE	OTHER
505	DREDGE, SCALLOP	DREDGE	DREDGE	OTHER
506	DREDGE, SCALLOP, TURTLE DEFLECTOR	DREDGE	DREDGE	OTHER
507	DREDGE, SCALLOP, CHAIN MAT	DREDGE	DREDGE	OTHER
508	DREDGE, SCALLOP, CHAIN MAT, MODIFIED	DREDGE	DREDGE	OTHER
509	DREDGE, MUSSEL	DREDGE	DREDGE	OTHER
511	DREDGE, NEW BEDFORD	DREDGE	DREDGE	OTHER
512	DREDGE, DIGBY	DREDGE	DREDGE	OTHER
513	DREDGE, OYSTER	DREDGE	DREDGE	OTHER
550	DIP NETS	DIP NETS	DIP NETS AND CAST NETS	OTHER
551	CAST NETS	DIP NETS	DIP NETS AND CAST NETS	OTHER
552	BULLY NETS	DIP NETS	DIP NETS AND CAST NETS	OTHER
553	UMBRELLA/SCAP NETS	DIP NETS	DIP NETS AND CAST NETS	OTHER
600	TONGS	TONGS	RAKES, HOES, AND TONGS	OTHER
601	HAND TONGS	TONGS	RAKES, HOES, AND TONGS	OTHER
602	PATENT TONGS	TONGS	RAKES, HOES, AND TONGS	OTHER
620	RAKES	RAKES	RAKES, HOES, AND TONGS	OTHER
621	RAKES, BULL	RAKES	RAKES, HOES, AND TONGS	OTHER
622	RAKES, OYSTER	RAKES	RAKES, HOES, AND TONGS	OTHER
623	RAKES, HAND	RAKES	RAKES, HOES, AND TONGS	OTHER
630	HOES	HOES	RAKES, HOES, AND TONGS	OTHER
631	RAKES/SHOVELS/PITCHFORKS	RAKES/SHOVELS/PITCHFORKS	RAKES, HOES, AND TONGS	OTHER
632	PICKS	PICKS	RAKES, HOES, AND TONGS	OTHER
633	SCRAPES	SCRAPES	RAKES, HOES, AND TONGS	OTHER
650	HARPOONS	HARPOONS	SPEARS AND GIGS	OTHER
663	POWERHEADS	SPEARS	SPEARS AND GIGS	OTHER
670	HANDHELD HOOKS	HANDHELD HOOKS	SPEARS AND GIGS	OTHER
671	SPONGE HOOKS	HANDHELD HOOKS	SPEARS AND GIGS	OTHER
702	HAND LINES, AUTO JIG	HAND LINE	HAND LINE	OTHER
750	BY HAND, DIVING GEAR	BY HAND, DIVING GEAR	BY HAND	OTHER
760	BY HAND, NO DIVING GEAR	BY HAND, NO DIVING GEAR	BY HAND	OTHER
761	KNIFE, SEAWEED	BY HAND, NO DIVING GEAR	BY HAND	OTHER
762	WEEDWACKER, SEAWEED	BY HAND, NO DIVING GEAR	BY HAND	OTHER
800	OTHER GEARS	OTHER GEARS	OTHER GEARS	OTHER
801	UNSPECIFIED GEAR	OTHER GEARS	OTHER GEARS	OTHER
802	COMBINED GEARS	OTHER GEARS	OTHER GEARS	OTHER
803	AQUACULTURE	OTHER GEARS	OTHER GEARS	OTHER
804	CHEMICAL, OTHER	OTHER GEARS	OTHER GEARS	OTHER
805	BUSH NET	OTHER GEARS	OTHER GEARS	OTHER
806	BOW AND ARROW	OTHER GEARS	OTHER GEARS	OTHER
807	DRAG, ELECTRO	OTHER GEARS	OTHER GEARS	OTHER
808	OYSTER CAGE	OTHER GEARS	OTHER GEARS	OTHER
809	FISHING, ELECTRO	OTHER GEARS	OTHER GEARS	OTHER
810	SUCTION PUMP	SUCTION PUMPS	OTHER GEARS	OTHER
811	SUCTION PUMP, DIVING	SUCTION PUMPS	OTHER GEARS	OTHER
50	POUND NETS	POUND NETS	FIXED NETS	Pound Net
10	HAUL SEINES	HAUL SEINES	HAUL SEINES	Seine
21	STOP SEINE	OTHER SEINES	HAUL SEINES	Seine
22	COMMON SEINE	OTHER SEINES	HAUL SEINES	Seine
23	SWIPE NET	OTHER SEINES	HAUL SEINES	Seine
30	PURSE SEINE	PURSE SEINE	PURSE SEINES	Seine

Table 17. (cont.)

ACCSP Gear Code	ACCSP Gear Name	ACCSP Category Name	ACCSP Type Name	SEDAR Gear
31	PURSE SEINE, TARP	PURSE SEINE	PURSE SEINES	Seine
80	BEAM TRAWLS	BEAM TRAWLS	TRAWLS	Trawls
81	BEAM TRAWLS, FISH	BEAM TRAWLS	TRAWLS	Trawls
82	BEAM TRAWLS, OTHER - SHRIMP, CHOPSTICKS	BEAM TRAWLS	TRAWLS	Trawls
90	OTTER TRAWLS	OTTER TRAWLS	TRAWLS	Trawls
91	OTTER TRAWL BOTTOM, CRAB	OTTER TRAWLS, BOTTOM	TRAWLS	Trawls
92	OTTER TRAWL BOTTOM, FISH	OTTER TRAWLS, BOTTOM	TRAWLS	Trawls
93	OTTER TRAWL BOTTOM, LOBSTER	OTTER TRAWLS, BOTTOM	TRAWLS	Trawls
94	OTTER TRAWL BOTTOM, SCALLOP	OTTER TRAWLS, BOTTOM	TRAWLS	Trawls
95	OTTER TRAWL BOTTOM, SHRIMP	OTTER TRAWLS, BOTTOM	TRAWLS	Trawls
96	OTTER TRAWL BOTTOM, OTHER	OTTER TRAWLS, BOTTOM	TRAWLS	Trawls
97	OTTER TRAWL MIDWATER	OTTER TRAWLS, MIDWATER	TRAWLS	Trawls
98	OTTER TRAWL, HADDOCK SEPARATOR	OTTER TRAWLS, BOTTOM	TRAWLS	Trawls
99	OTTER TRAWL, RUHLE	OTTER TRAWLS, BOTTOM	TRAWLS	Trawls
100	OTTER TRAWL, TWIN	OTTER TRAWLS, BOTTOM	TRAWLS	Trawls
101	OTTER TRAWL, LARGE MESH BELLY PANEL	OTTER TRAWLS, BOTTOM	TRAWLS	Trawls
102	OTTER TRAWL BOTTOM, TWIN, SHRIMP	OTTER TRAWLS, BOTTOM	TRAWLS	Trawls
110	OTHER TRAWLS	OTHER TRAWLS	TRAWLS	Trawls
111	TRAWL, CLAM KICKING	OTHER TRAWLS	TRAWLS	Trawls
112	OTTER TRAWL MIDWATER, PAIRED	OTTER TRAWLS, MIDWATER	TRAWLS	Trawls
113	OTTER TRAWL BOTTOM, PAIRED	OTTER TRAWLS, BOTTOM	TRAWLS	Trawls
114	TRAWL, ROLLER	OTHER TRAWLS	TRAWLS	Trawls
115	TRAWL, ROLLER FRAME	OTHER TRAWLS	TRAWLS	Trawls
116	TRAWL, SKIMMER	OTHER TRAWLS	TRAWLS	Trawls
117	SCOTTISH SEINE	OTHER TRAWLS	TRAWLS	Trawls
118	BUTTERFLY NETS	OTHER TRAWLS	TRAWLS	Trawls
119	DANISH SEINE	OTHER TRAWLS	TRAWLS	Trawls
120	FLY NET	OTHER TRAWLS	TRAWLS	Trawls
121	OTTER TRAWL, PEELER	OTTER TRAWLS, BOTTOM	TRAWLS	Trawls

**Table 18. Commercial landings data collection methodology by state.**

	1950-1977	1978-1985	1986-1988	1989	1990-1993	1994	1995-2000	2001-2003	2004	2005	2006	2007-today
ME DMR												
NH FGD												
MA DMF												
RJ DFW												
CT DEEP												
NY DEC												
NJ DEP												
DE DFW												
MD DNR												
VMRC												
NC DMF												
SC DNR												
GA DNR												
FL FWC												
	Annual summaries		Monthly summaries		Mixed (trip reports and monthly summaries)		Trip reports (all fisheries)					

**Table 19. GLM estimated discards from the estuarine gill net fishery in North Carolina.**

Fishing Year	Observed Trips	Lengths collected	Dead discards	5% of releases	Total discards
1981	0	0	2,159	250	2,410
1982	0	0	1,802	209	2,010
1983	0	0	16,283	1,887	18,170
1984	0	0	9,954	1,154	11,108
1985	0	0	7,507	870	8,377
1986	0	0	8,215	952	9,167
1987	0	0	9,623	1,115	10,738
1988	0	0	10,418	1,207	11,625
1989	0	0	10,218	1,184	11,403
1990	0	0	7,414	859	8,273
1991	0	0	12,652	1,466	14,118
1992	0	0	18,443	2,137	20,581
1993	0	0	12,611	1,462	14,073
1994	0	0	4,682	543	5,224
1995	0	0	15,870	1,839	17,709
1996	0	0	3,093	358	3,451
1997	0	0	12,932	1,499	14,431
1998	0	0	28,981	3,359	32,339
1999	0	0	33,728	3,909	37,637
2000	0	0	11,310	1,311	12,621
2001	0	0	4,013	465	4,478
2002	0	0	8,411	975	9,385
2003	0	0	5,344	619	5,964
2004	535	839	14,302	1,792	16,094
2005	457	762	14,806	1,264	16,070
2006	184	353	14,846	1,423	16,268
2007	250	275	10,490	967	11,457
2008	194	345	17,007	1,302	18,308
2009	280	279	9,188	786	9,974
2010	394	114	1,530	356	1,887
2011	660	266	3,362	327	3,689
2012	626	1,838	33,703	5,245	38,948
2013	739	1,112	15,180	2,616	17,796
2014	926	944	13,612	1,633	15,245
2015	699	420	6,369	812	7,181
2016	721	977	16,266	1,620	17,886
2017	497	526	7,355	1,486	8,841
2018	351	130	3,164	367	3,531
2019	97	136	7,088	1,169	8,257
2020					
2021	7	8	2,626	368	2,994
2022	32	71	20,854	1,007	21,861

**Table 20. North Carolina red drum lengths obtained by year and gear from commercial fishery-dependent fish house sampling.**

Fishing Year	Beach Seine	Gill Net	Haul Seine	Hook & Line	Ocean Trawl	Pound Net	Total
1989	0	0	23	7	0	0	30
1990	0	373	28	0	2	78	481
1991	18	228	12	0	1	34	293
1992	4	372	91	9	4	60	540
1993	9	230	56	0	2	26	323
1994	0	147	47	0	1	8	203
1995	0	177	83	0	23	73	356
1996	0	211	8	0	1	6	226
1997	7	535	202	0	0	10	754
1998	14	586	12	0	0	6	618
1999	84	776	25	0	4	51	940
2000	2	428	4	0	17	16	467
2001	2	324	26	0	0	30	382
2002	7	356	26	0	0	37	426
2003	48	346	6	0	0	2	402
2004	10	493	1	0	0	9	513
2005	8	945	19	0	0	72	1,044
2006	41	1,075	28	0	7	59	1,210
2007	10	1,491	1	0	4	147	1,653
2008	35	923	39	0	0	72	1,069
2009	0	900	18	0	0	45	963
2010	12	842	4	0	0	75	933
2011	6	423	2	0	0	44	475
2012	18	897	16	0	0	36	967
2013	14	760	7	0	0	159	940
2014	5	606	9	0	0	19	639
2015	3	565	0	0	0	21	589
2016	7	564	2	0	0	18	591
2017	0	632	1	0	0	22	655
2018	0	316	3	0	0	55	374
2019	3	247	3	0	0	17	270
2020	9	638	5	0	0	65	717
2021	8	747	13	0	0	59	827
2022	0	464	28	0	0	12	504
<b>Total</b>	<b>384</b>	<b>18,617</b>	<b>848</b>	<b>16</b>	<b>66</b>	<b>1,443</b>	<b>21,374</b>

**Table 21. Number of commercial red drum harvested by gear and year from 1989 to 2022 in North Carolina.**

Fishing Year	Beach Seine	Gill Net	Haul Seine	Hook & Line	Ocean Trawl	Other	Pound Net	Total
*1989	258	2,484	697	65	56	245	715	4,520
1990	10529	53,197	7875	104	194	5186	3,239	80,324
1991	1585	32,812	1243	225	17	1990	1,226	39,098
1992	553	31,082	2274	97	844	240	2,024	37,114
1993	1481	32,833	2750	661	69	276	1,392	39,462
1994	447	17,794	4488	452	60	185	1,376	24,802
1995	1705	38,729	7382	567	157	85	3,196	51,821
1996	146	9,311	1108	382	28	34	880	11,889
1997	2667	61,396	13621	1073	0	34	495	79,286
1998	918	63,458	837	799	80	38	546	66,676
1999	3330	77,811	664	597	119	96	1,681	84,298
2000	806	31,774	85	245	75	15	878	33,878
2001	34	13,771	118	76	14		932	14,945
2002	217	22,499	355	50	4	42	1,270	24,437
2003	215	11,839	227	31	9	7	457	12,785
2004	141	17,327	60	63	0	39	466	18,096
2005	347	31,813	299	69	2	53	1,537	34,120
2006	472	33,004	638	56	10	156	1,273	35,609
2007	111	66,013	126	26	38	24	1,495	67,833
2008	145	28,102	775	19	0	30	1,084	30,155
2009	105	54,498	390	48	0	35	1,417	56,493
2010	44	24,205	313	33	0	19	1,132	25,746
2011	40	16,422	54	51	0	22	1,069	17,658
2012	46	42,535	330	113	0	91	1,406	44,521
2013	83	50,627	206	98	0	51	6,823	57,888
2014	40	23,346	133	78	0	63	1,584	25,244
2015	16	12,561	27	33	0	36	845	13,518
2016	10	23,996	66	73	0	77	1,183	25,405
2017	19	34,652	154	89	0	93	4,461	39,468
2018	41	18,757	10	64	0	17	1,702	20,591
2019	62	12,335	589	21	0	5	1,139	14,151
2020	102	39,281	786	54	0	69	5,302	45,594
2021	126	40,725	229	48	0	116	2,913	44,157
2022	6	35,806	154	97	0	32	3,303	39,398

**Table 22. Recreational commercial gill net landings from North Carolina from 1989 to 2022.**

Fishing Year	RCGL Harvest in weight (lb)	RCGL harvest in numbers
1989	9,097	6,094
1990	6,098	3,472
1991	6,144	2,142
1992	10,531	2,029
1993	12,495	2,143
1994	5,067	1,161
1995	12,839	2,528
1996	2,992	608
1997	12,352	4,008
1998	16,347	4,142
1999	24,750	5,079
2000	10,190	2,074
2001	3,633	899
2002	6,327	1,469
2003	4,255	773
2004	3,863	1,131
2005	9,552	2,077
2006	10,316	2,154
2007	20,705	4,309
2008	8,044	1,834
2009	17,321	3,557
2010	7,629	1,580
2011	5,707	1,072
2012	8,380	2,776
2013	14,899	3,305
2014	8,426	1,524
2015	3,853	820
2016	6,774	1,566
2017	11,343	2,262
2018	6,177	1,224
2019	3,072	805
2020	11,538	2,564
2021	13,009	2,658
2022	11,180	2,337



**Table 23. Florida red drum landings during the 1980s in numbers of fish (Murphy 2009).**

Year	Landings
1981	87,276
1982	33,931
1983	37,248
1984	38,431
1985	26,050
1986	22,609
1987	12,793
1988	73

**Table 24. Expanded catch-at-length for the major North Carolina commercial gears from 1989 to 2022.**

*Beach Seine*

Fishing Year	14	24	26	28	30	32	34	36	38	40	42	44	46	48	50	52	54	56	58	60	62	64	66	68	70	72	74	76	78	80+		
1989						95			14			11	11	18	18	11						11	4	4		4	4	4		53		
1990					13	40	661	1363	2538	1485	1039	1363	1134	297	27		27	13	27	40	13	94	13			13	27			297		
1991												413	827	207	69	69																
1992	1		5					0		0	1	1	6	40	29	50	25	41	54	77	93	43	37	27	9	0	0	1	1	14		
1993								11				4	36	29	93	37	236	131	240	205	115	83	27	174	27	4	3	1		23		
1994								1		2	2	1	8	16	27	51	76	38	26	37	53	5	35	28	9	8	17			5		
1995											0	2	8	2	1	18	79	213	340	406	378	153	84	14	6		1		0	0		
1996		0	0								1	4	14	31	27	18	8	1	0	1	3	9	13	11	4	2						
1997					1	1	1	0	0	0	2	92	674	762	562	360	134	51	22	1	1	1	1							1		
1998							3	1				21	79	86	91	70	85	101	139	106	55	33	23	6	5	6	8					
1999													110	55	27			192	220	521	877	650	421	82	119							
2000												7	23	20	20	25	68	83	128	121	118	91	52	28	10	5	5			2		
2001												1	5	5	3	3	4	4	3	2	2	1	1	1	0	0			0			
2002						0						6	28	31	17	14	15	13	15	14	19	20	14	5	2			1				
2003												18	35	22	18	4		22	4	22	39	9	18		4							
2004										1		10	34	22	14	9	16	13	7	5	4	3	2	1		1	0					
2005							0					10	28	28	26	19	29	28	30	28	40	39	21	12	7	2	1					
2006								15				29	29	17	14	17	23	23	54	101	33	55	39	8				14				
2007								0	0		0	0	2	3	4	6	9	17	20	19	14	10	4	2	1	0	0	0	0	0	0	
2008																		8	4	20	33	25	21	21		4	4			4		
2009								0				0	2	3	3	4	9	11	21	20	12	10	5	3	1	0	0			0		
2010							0			0		1	3	2	2	1	2	3	6	7	7	5	3	1	1	0	0	0				
2011												0	1	2	1	0	1	3	5	8	7	5	3	2	1	0				0		
2012					0					0	0	2	12	11	7	4	3	1	1	1	1	1	0	0	0	0						
2013									0			0	3	3	4	7	11	14	14	14	8	4	1	1	0	0						
2014												0	1	1	1	1	2	3	6	6	6	5	5	3	2	0	0					
2015												0	2	1	1	1	1	1	1	1	2	2	1	1	0	0						
2016										0		0	2	1	1	1	0	0	0	1	1	1	1	0	0	0	0					
2017												0	0	1	1	1	1	1	3	3	3	2	2	1	0	0	0					
2018					1			0				0	2	2	1	1	2	4	4	5	7	5	4	2	1	0			0			
2019								0		0	0	3	13	11	6	5	3	2	2	2	3	4	3	2	1	1						
2020												0	2	3	8	10	13	16	13	15	11	5	4	2	0	0						
2021							0					0	1	4	5	9	12	18	17	15	13	14	11	5	2	1	0				0	
2022												0	0	0	0	1	1	1	1	1	1	1	0	0	0	0	0	0			0	0

*Gill Net*

Fishing																										
Year	30	32	34	36	38	40	42	44	46	48	50	52	54	56	58	60	62	64	66	68	70	72	74	76	78	80+
1989		919			136			102	102	170	170	102						102	34	34		34	34	34		510
1990	118	353	2763	10228	13930	10229	7348	4173	1940	764	118		118	118	235	411		235					118			
1991						254	3115	13665	4846	2840	1394	2661	560	1104	65					747	1071		357			133
1992				41		41			20	652	4208	3025	2848	1408	632	1655	2715	4484	2734	3172	2690	675				82
1993								116	963	765	2496	823	5905	3066	5566	3850	2185	1657	547	4388	470	39				
1994				39		116	116		413	503	961	1967	3089	1522	1013	1742	2517	181	1769	955	387	387				39
1995							19	56	94	56		19	1883	1907	8563	11643	7396	4152	2481	423	19		19			
1996							83	253	906	1980	1719	1130	498	44	16	24	172	578	783	740	253	131				
1997	32	20	41				10	811	9205	17769	14873	12187	3826	1655	836	51	20	39	10							10
1998			184	92				1351	5613	6180	6753	5126	6106	7035	9960	7103	3789	2127	1480	466	92					
1999							77	695	4298	3750	2485	2415	5607	9371	9617	11533	11007	9016	4237	2494	528	309	77		295	
2000								285	997	867	854	1068	2758	3409	5301	4692	4477	3656	1780	1133	285	142	71			
2001								288	2470	2137	1081	957	1611	1527	1233	987	575	247	288	370						
2002								764	2971	2606	1716	1380	1882	1569	1882	1694	1945	2144	1318	502	125					
2003								135	440	745	237	203	203	856	1534	1693	1735	1693	1002	698	474	156		34		
2004							133	1239	4233	2820	1784	1143	1995	1668	726	567	350	267	200	100		67	33			
2005			32					1044	2842	2745	2561	1806	2885	2560	2763	2445	3631	3200	1602	942	529	195	32			
2006						29	87	407	2364	1958	1997	1424	1698	2660	4511	4761	3902	3493	2088	957	465	116			87	
2007				42	42		84	211	1139	1801	2242	3412	5413	10090	11630	11816	8479	5594	2367	975	464	127	42	42		
2008			29	87	29	231	116	694	2485	2845	2152	1803	1872	2915	2757	3205	2435	2095	1283	638	260	144	29			
2009					116			174	1420	1217	1480	1883	4962	6200	10952	10525	6372	4910	2379	1446	290	58	58			58
2010				33			25	450	1737	1164	1301	601	968	1908	3419	4010	3653	2802	1411	423	175	100	25			
2011								74	296	704	259	222	593	1148	2148	3252	2963	1955	1362	741	519	185				
2012	45						91	1910	12271	10657	6582	3903	2641	935	1137	727	546	546	273	136	91	45				
2013					49			97	1510	2028	2337	4513	6795	8892	8365	8493	4430	2550	244	151	49	123				
2014								38	380	493	493	645	987	1480	3112	3468	3334	3248	2725	1825	891	152	76			
2015								193	1243	1056	858	1079	1119	751	837	1048	1245	1652	708	558	150	64				
2016							159	1008	4144	3431	1640	1803	1070	753	1137	1704	2052	2159	1268	938	609	79	40			
2017								211	684	1875	1422	1983	2159	2422	4715	5366	4671	4119	2851	1648	316	158	53			
2018				57				114	1315	1200	343	537	1127	1586	2020	2296	2698	1903	1778	1086	400	240		57		
2019				47		47	47	675	2715	2165	1167	986	560	426	474	332	568	805	637	542	95	47				
2020								117	822	1467	3703	4128	5410	5637	4806	4871	3813	2219	1408	763	117					
2021			51					51	205	869	1505	2915	3916	5591	5450	4914	4388	4832	3617	1586	630	153	51			
2022								293	1097	1024	1829	3306	4786	3851	3947	3250	3729	4009	2016	1353	805	365			73	73

## Haul Seine

Fishing																													
Year	14	24	26	30	32	34	36	38	40	42	44	46	48	50	52	54	56	58	60	62	64	66	68	70	72	74	76	78	80+
1989					294			45			27	27	55	55	27						27	11	11		11				107
1990						894	363	2199	367	93	1902	1902		39		39													77
1991						21		6	18	101	447	180	98	50	87	18	84	2	49		3		24	36	1	11			8
1992	5		49									2	2	4	214	110	328	361	450	471	108	36		4	2	2	5	9	114
1993							249							31	203	173	410	488	203	268	95	95	78	31	61				366
1994											56		442	561	855	1096	583	263	88	176				88					281
1995														153	338	1521	1416	1396	1963	447	149								
1996		1	3							10	30	107	233	202	133	58	6	3	4	22	69	96	87	30	15				
1997										10	876	5442	3826	2275	614	450	112	11	6										
1998						2	1				19	72	79	83	64	78	92	127	97	50	30	21	6	5	6	7			
1999											61	118	110	31	56	18	78	18	18	26	77	53							
2000											1	2	2	2	3	7	9	13	13	12	10	5	3	1	1	1			0
2001													5	30	23	21	5	16	6	3					3			6	
2002												24	107	24	71	12		12	24	24	24	12					24		
2003											4	12	15	7	4	4	17	26	31	33	29	20	12	9	3	1	1		
2004										0	4	14	9	6	4	7	6	3	2	2	1	1	0		0	0			
2005						0					9	24	24	22	16	25	24	26	24	34	33	18	10	6	2	1			
2006												37	106	120	93		17	95	61	28	17	45	20						
2007							0	0		0	0	2	3	4	6	10	19	23	22	16	11	5	2	1	0	0	0	0	0
2008											37	12	237	49	208	112	25		12		12	15	34						22
2009								1			1	9	10	11	14	35	43	76	75	46	36	18	11	2	1	1			0
2010						0				0	6	23	14	16	7	11	22	40	52	48	38	19	9	4	3	0	0		
2011											0	1	2	1	1	2	4	7	11	10	7	5	2	2	1				0
2012				0					0	1	14	89	81	53	32	23	9	8	6	4	4	2	1	1	0				
2013								0			0	6	7	9	17	26	35	34	20	11	2	2	0	1					
2014											0	2	3	3	4	6	8	19	20	19	18	15	10	5	1	1			
2015											0	3	2	2	2	2	2	2	2	3	4	1	1	0	0				
2016									0		3	11	10	4	5	3	2	3	4	6	6	4	3	2	0	0			
2017											1	3	8	6	9	10	12	20	24	21	19	13	7	1	1	0			
2018				0			0				0	1	1	0	0	1	1	1	1	2	1	1	1	0	0		0		
2019							2		2	2	29	123	107	60	49	25	18	21	23	27	37	31	23	6	6				
2020											2	17	25	64	74	100	121	98	112	86	42	28	13	2	1				
2021						0					0	1	7	10	16	21	32	30	27	24	25	19	10	4	2	0			0
2022												11	17	6	6	11	6			22	11	11	17	28	6	6			

**Pound Net**

Fishing Year	24	26	30	32	34	36	38	40	42	44	46	48	50	52	54	56	58	60	62	64	66	68	70	72	74	76	78	80+	
1989				264			39			29	29	49	49	29						29	10	10		10	10	10		147	
1990					77	127	338	336	322	425	478	413							26	123	26			26	29			495	
1991							72			108	397	144	144	36						108				72	36			108	
1992									60	95							35	369	162	526	345	166	230					36	
1993														77	78	102	174	532	249	40	26	45	70						
1994						2		7	7	2	26	50	83	156	234	116	81	114	163	14	109	85	28	24	52			17	
1995										64	506	61	49	31	31	184	233	306	361	487	662	61	61		31		34	34	
1996	1	2							8	24	85	185	160	106	46	5	2	3	17	55	76	69	24	12					
1997			0	0	0	0	0	0	0	17	125	141	104	67	25	10	4	0	0	0	0							0	
1998					1	1				13	47	51	54	42	51	60	83	63	33	19	13	4	3	4	4				
1999										28	28				70	98	204	366	481	266	70	28		42					
2000										7	25	22	22	27	74	91	139	132	129	100	56	31	11	5	5			2	
2001											31	31			31	93	124	62	186	124	155	62	31						
2002				27							202	270	115	27		27			162	108	196	54	81						
2003										9	24	30	13	8	8	34	52	62	67	58	40	24	19	7	1	1			
2004									3	33	112	73	47	29	53	44	23	17	12	9	5	3		3	1				
2005											20			20		60	60	227	243	387	310	143	47		20				
2006															33	33	328	148	300	317	66	16	33						
2007										18	21	37	63	130	159	317	252	170	152	80	27	17	18			18	9	9	
2008											15	34	15	15	63	58	160	145	116	87	102	116	87	73					
2009															109	244	410	192	272	27	108				54				
2010											44	15						196	207	205	145	161	102	44		15			
2011										24	24	73				73	49	146	170	243	121	49	49					49	
2012							38			76	570	361	152	57				38	76				38						
2013											299	32	326	379	581	867	1150	1146	993	558	193	235	32	32					
2014										2	24	32	32	44	68	99	228	233	228	211	180	124	61	12	7				
2015										40	40	121	40	40	40		40	121	161		80	80	80						
2016									7	51	204	172	79	84	52	37	54	80	99	109	66	51	32	4	2				
2017															811	1217		608	608	811	406								
2018			171							24		24		24		171	24	193	419	289	217	96	24			24			
2019						4		4	4	56	238	206	115	95	48	36	40	44	52	71	60	44	12	12					
2020														136	409	1295	799	1814	526	205	117								
2021												296	197	148	49	543	296	296	247	99	99	296	99	197				49	
2022										25	105	105	166	320	413	345	370	296	339	351	191	148	74	37	6		6	6	

**Table 25. Recreational red drum catch estimates (1,000s of fish) for the northern stock from MRIP. \*\*2022 data are preliminary.**

Fishing Year	Harvest		Released Alive	
	Estimate	PSE	Estimate	PSE
1981	63.35	0.31	10.50	0.97
1982	84.71	0.41	0.00	0.00
1983	98.16	0.37	8.87	0.87
1984	416.97	0.23	3.33	0.84
1985	110.27	0.29	5.46	1.00
1986	370.20	0.43	30.29	0.50
1987	268.63	0.30	39.11	0.41
1988	521.69	0.53	119.99	0.54
1989	272.24	0.38	41.54	0.54
1990	92.22	0.24	87.14	0.33
1991	166.07	0.21	399.82	0.20
1992	73.27	0.21	475.70	0.64
1993	137.65	0.18	499.05	0.37
1994	73.48	0.27	247.62	0.16
1995	153.12	0.13	371.40	0.16
1996	69.07	0.31	149.32	0.20
1997	96.11	0.18	758.89	0.17
1998	186.99	0.15	880.09	0.27
1999	210.25	0.13	1,241.29	0.15
2000	122.81	0.21	433.36	0.18
2001	92.83	0.20	981.16	0.17
2002	252.16	0.20	3,409.15	0.17
2003	91.99	0.21	254.99	0.16
2004	62.61	0.25	439.95	0.13
2005	160.02	0.17	1,432.80	0.26
2006	220.27	0.21	1,300.79	0.17
2007	236.27	0.13	1,456.30	0.13
2008	245.91	0.18	2,523.55	0.15
2009	309.10	0.14	1,571.62	0.11
2010	187.48	0.15	1,307.85	0.11
2011	274.98	0.31	5,791.62	0.21
2012	491.19	0.19	10,570.66	0.14
2013	907.53	0.17	2,597.72	0.30
2014	228.67	0.17	1,541.42	0.29
2015	142.49	0.26	1,170.22	0.14
2016	590.71	0.34	4,771.46	0.28
2017	469.11	0.19	3,203.34	0.25
2018	213.99	0.32	1,559.18	0.27
2019	475.91	0.19	4,897.81	0.14
2020	767.84	0.18	3,587.11	0.16
2021	539.14	0.12	3,587.29	0.17
2022	321.61	0.14	2,209.79	0.14

**Table 26. Recreational red drum catch estimates (1,000s of fish) for the southern stock from MRIP. \*\*2022 data are preliminary.**

Fishing Year	South Carolina				Georgia				Florida			
	Harvest		Released Alive		Harvest		Released Alive		Harvest		Released Alive	
	Estimate	PSE	Estimate	PSE	Estimate	PSE	Estimate	PSE	Estimate	PSE	Estimate	PSE
1981	190.75	0.40	8.25	0.68	175.46	0.64	0.41	0.99	415.78	0.32	35.51	0.75
1982	278.77	0.34	114.84	0.08	65.17	0.29	8.75	0.61	804.34	0.42	105.74	0.54
1983	479.35	0.67	11.37	0.69	370.35	0.25	3.97	0.56	1,861.60	0.26	199.21	0.38
1984	326.28	0.39	60.67	0.68	466.78	0.22	15.59	0.43	1,642.06	0.28	147.84	0.48
1985	938.70	0.18	106.12	0.39	288.08	0.14	47.47	0.24	341.38	0.25	458.85	0.38
1986	310.74	0.23	71.75	0.29	123.33	0.19	194.53	0.19	121.35	0.33	248.59	0.26
1987	725.71	0.18	189.47	0.28	154.67	0.14	205.13	0.18	106.76	0.47	812.23	0.33
1988	388.19	0.27	131.64	0.28	155.87	0.22	173.38	0.25	20.02	0.51	337.67	0.25
1989	291.27	0.21	129.30	0.34	117.20	0.30	145.30	0.47	202.89	0.30	564.41	0.32
1990	404.94	0.31	139.61	0.43	175.24	0.25	202.83	0.26	87.71	0.33	967.57	0.41
1991	311.48	0.27	171.29	0.49	249.21	0.35	108.57	0.20	396.89	0.25	1,277.10	0.35
1992	285.42	0.22	131.02	0.29	151.19	0.18	227.04	0.30	195.05	0.16	1,532.44	0.16
1993	276.73	0.28	351.18	0.34	242.05	0.18	231.39	0.33	274.91	0.14	1,816.68	0.16
1994	97.46	0.30	639.92	0.21	165.63	0.23	446.40	0.28	354.81	0.18	2,256.37	0.17
1995	364.87	0.50	640.25	0.25	250.16	0.24	172.03	0.27	377.35	0.19	1,868.68	0.11
1996	349.94	0.27	844.34	0.43	115.46	0.27	108.41	0.32	352.47	0.19	1,026.13	0.17
1997	240.98	0.19	202.74	0.21	67.99	0.26	60.81	0.24	296.12	0.21	1,503.06	0.14
1998	194.23	0.17	305.07	0.18	84.33	0.32	75.74	0.37	428.95	0.17	2,060.40	0.11
1999	132.68	0.27	306.50	0.23	148.72	0.23	129.19	0.27	520.41	0.13	2,083.98	0.11
2000	88.54	0.24	205.13	0.23	189.89	0.24	320.23	0.22	652.69	0.13	2,579.70	0.14
2001	167.80	0.19	466.82	0.20	225.39	0.16	369.33	0.19	460.53	0.11	2,329.61	0.13
2002	194.04	0.20	607.53	0.20	259.79	0.19	455.45	0.17	561.08	0.16	2,755.51	0.17
2003	266.12	0.25	856.59	0.19	222.77	0.16	424.50	0.19	530.95	0.14	3,524.28	0.16
2004	176.80	0.19	721.04	0.20	215.28	0.17	300.69	0.23	548.77	0.14	4,145.14	0.12
2005	255.95	0.25	953.10	0.14	244.79	0.18	419.11	0.21	593.20	0.15	4,539.49	0.18
2006	138.47	0.27	1,181.79	0.17	126.13	0.26	334.19	0.18	509.67	0.13	2,193.53	0.12
2007	169.65	0.26	785.02	0.18	280.14	0.22	451.54	0.25	379.98	0.13	2,278.91	0.13

Fishing Year	South Carolina				Georgia				Florida			
	Harvest		Released Alive		Harvest		Released Alive		Harvest		Released Alive	
	Estimate	PSE	Estimate	PSE	Estimate	PSE	Estimate	PSE	Estimate	PSE	Estimate	PSE
2008	222.17	0.29	1,476.92	0.18	208.30	0.18	401.59	0.25	427.50	0.17	2,379.63	0.16
2009	303.12	0.18	1,541.42	0.15	181.42	0.22	574.45	0.17	640.95	0.14	3,530.62	0.12
2010	495.53	0.16	2,303.04	0.15	470.44	0.19	733.53	0.16	717.92	0.12	7,094.37	0.13
2011	216.04	0.21	1,314.78	0.13	139.93	0.22	352.74	0.23	841.64	0.17	2,878.45	0.11
2012	388.88	0.27	1,553.51	0.12	146.80	0.24	275.37	0.31	758.62	0.14	2,783.19	0.11
2013	214.36	0.15	1,394.64	0.09	232.47	0.18	578.76	0.20	1,075.91	0.12	6,084.90	0.14
2014	385.28	0.28	1,875.95	0.17	207.98	0.19	1,171.41	0.23	1,123.90	0.15	4,210.56	0.11
2015	266.71	0.31	1,537.67	0.23	220.23	0.21	538.01	0.22	839.80	0.14	4,452.51	0.12
2016	382.33	0.16	1,531.86	0.15	292.93	0.24	986.02	0.18	1,293.51	0.17	4,786.23	0.18
2017	359.50	0.19	2,047.33	0.17	517.97	0.22	974.70	0.18	926.94	0.21	5,711.24	0.16
2018	273.90	0.15	1,750.99	0.13	553.11	0.20	1,101.35	0.19	1,179.24	0.12	4,397.08	0.12
2019	309.62	0.25	2,816.14	0.21	283.06	0.24	864.34	0.36	515.84	0.18	3,287.01	0.16
2020	203.18	0.20	1,849.16	0.14	189.60	0.18	606.35	0.15	531.40	0.22	3,271.16	0.14
2021	231.87	0.15	1,496.35	0.16	393.52	0.21	1,061.19	0.21	688.97	0.34	5,191.63	0.32
2022	219.14	0.15	1,374.21	0.11	612.68	0.15	1,963.25	0.16	359.71	0.23	4,016.83	0.14



**Table 27. Fishery-dependent biological samples collected via the SCDNR freezer, tournament, and state finfish surveys.**

<b>Description</b>	<b>Tournament Program</b>	<b>Freezer Program</b>	<b>State Finfish Survey</b>	<b>Fishery-Dependent Samples</b>
<b>Years</b>	<b>1986-2022</b>	<b>1995-2022</b>	<b>1988-2022</b>	<b>1986-2022</b>
<b>Red Drum Investigated</b>	<b>1,023</b>	<b>2,283</b>	<b>11,487</b>	<b>14,793</b>
<b>Total Length (mm)</b>	<b>1,021</b>	<b>2,275</b>	<b>2,814</b>	<b>6,110</b>
<b>Midline Length (mm)</b>	<b>1,049</b>	<b>2,485</b>	<b>8,673</b>	<b>12,207</b>
<b>Standard Length (mm)</b>	<b>1,019</b>	<b>2,236</b>		<b>3,255</b>
<b>Weight (g)</b>	<b>986</b>	<b>5</b>		<b>991</b>
<b>Age (Yrs)</b>	<b>1,007</b>	<b>2,229</b>		<b>3,236</b>
Length	161	859		1,020
Scale	17	1		18
Otoliths	829	1,369		2,198
<b>Sex</b>	<b>1,017</b>	<b>2,282</b>		<b>3,299</b>
Macroscopic	971	2,278		3,249
Histology	46	4		50
<b>Maturity Status/Stage</b>	<b>969</b>	<b>2,200</b>		<b>3,169</b>
Macroscopic	923	2,196		3,119
Histology	46	4		50

Note: Data was not updated to reflect collections made in the first half of 2023, which was included in the fishing year definition but not available during data workshop.

**Table 28. MGFTP guidance to anglers for tagging red drum throughout coastal South Carolina.**

<b>Years</b>	<b>Guidance</b>
1978-1992	Any size red drum
1993-2010	≥18 inches (457.2 mm) TL
2011-2019	Fish <27 inches (658.8 mm) TL - T-bar tag Fish ≥27 inches (658.8 mm) TL - Nylon Dart Tag
2020-2022	Previous tag types + only fish ≥10 inches (254 mm) TL Tag one red drum per "school" per day

**Table 29. Number of recaptures as a function of years-at-large from the SCDNR conventional tagging program.**

<b>Years-at-Large</b>	<b>Recaptures</b>
0-1	31,457
1-2	8,315
2-3	2,216
3-4	510
5-6	179
6-7	84
7-8	31
8-9	44
9-10	32
10-11	27
11-12	23
12-13	15
13-14	9
14-15	8
15-16	5
16-17	7
17-18	5
18-19	7
19-20	3
20-21	1
21-22	4
22-23	0
23-24	1
24-25	0

**Table 30. Indices of abundance for the northern red drum stock. Indices are scaled to their means and SEs are in terms of log(Index).**

Fishing Year	NC_BagSeine		NC_GillNet		NC_Longline	
	Index	SE	Index	SE	Index	SE
1991	2.753	0.219				
1992	0.750	0.230				
1993	3.951	0.226				
1994	1.138	0.231				
1995	0.652	0.215				
1996						
1997	1.840	0.198				
1998	1.620	0.214				
1999	0.342	0.236				
2000	0.651	0.223				
2001	0.268	0.242				
2002	0.408	0.225				
2003	0.742	0.207	0.388	0.173		
2004	1.473	0.213	1.422	0.153		
2005	1.631	0.214	1.537	0.153		
2006	0.569	0.219	0.863	0.144		
2007	0.660	0.205	0.501	0.181	0.708	0.219
2008	0.211	0.228	1.123	0.178	0.297	0.235
2009	0.247	0.230	1.079	0.170	0.667	0.205
2010	0.718	0.216	1.207	0.150	0.747	0.212
2011	1.413	0.219	0.171	0.197	0.468	0.205
2012	0.410	0.228	2.808	0.155	1.138	0.208
2013	0.215	0.241	1.338	0.152	1.150	0.209
2014	0.265	0.233	0.844	0.148	2.254	0.267
2015	0.844	0.218	0.736	0.148	1.218	0.227
2016	1.141	0.211	0.971	0.150	1.022	0.252
2017	0.578	0.214	0.585	0.148	1.132	0.220
2018	2.765	0.223	0.346	0.154	2.495	0.279
2019	0.900	0.208	1.442	0.154	0.605	0.246
2020	0.669	0.212				
2021	0.968	0.214	1.014	0.165	0.928	0.233
2022	0.211	0.227	0.625	0.194	0.170	0.239

**Table 31. Indices of abundance for the southern red drum stock. Indices are scaled to their means and SEs are in terms of log(Index).**

Fishing Year	SC_Rotenone		SC_StopNet		SC_Trammel		SC_Electro		SC_Longline_historic		SC_Longline_contemporary		GA_GillNet		GA_Longline		FL_21.3_HaulSeine		FL_183_HaulSeine		
	Index	SE	Index	SE	Index	SE	Index	SE	Index	SE	Index	SE	Index	SE	Index	SE	Index	SE	Index	SE	
1986	2.208	0.407																			
1987	1.273	0.431	1.076	0.274																	
1988	0.368	0.585	0.991	0.281																	
1989	0.642	0.434	0.864	0.255																	
1990	1.781	0.456	0.944	0.24																	
1991	0.703	0.468	1.208	0.245	2.443	0.174															
1992	0.219	0.595	1.023	0.244	1.79	0.136															
1993	0.807	0.53	0.893	0.26	1.728	0.112															
1994					1.033	0.1			1.111	0.205											
1995					1.483	0.096			1.327	0.182											
1996					0.906	0.095			1.189	0.159											
1997					0.83	0.09			0.493	0.185											
1998					0.654	0.089			0.795	0.165											
1999					0.501	0.093			1.223	0.165											
2000					1.044	0.092			0.679	0.172											
2001					1.264	0.089	0.997	0.101	1.008	0.161							0.754	0.365	1.468	0.229	
2002					1.41	0.088	1.492	0.096	1.17	0.172			1.62	0.224			1.608	0.346	1.077	0.228	
2003					1.638	0.085	1.326	0.089	1.336	0.164			0.803	0.199			1.678	0.367	2.096	0.21	
2004					1.482	0.086	0.773	0.092	0.905	0.173			1.675	0.181			0.673	0.396	1.371	0.216	
2005					1.307	0.087	0.811	0.091	1.119	0.321			0.421	0.181			0.119	0.761	1.625	0.224	
2006					0.684	0.09	0.66	0.093	0.644	0.235			0.807	0.226	0.295	0.361	1.255	0.293	0.762	0.258	
2007					0.85	0.089	0.916	0.101			1.083	0.279	1.362	0.222	0.343	0.375	1.652	0.281	1.005	0.234	
2008					0.938	0.09	1.22	0.088			1.262	0.272	0.782	0.22	0.33	0.307	1.376	0.273	0.79	0.243	
2009					1.283	0.087	1.314	0.088			2.454	0.266	1.537	0.193	0.935	0.335	1.337	0.277	1.686	0.216	
2010					1.054	0.086	1.088	0.096			0.625	0.164	0.584	0.213	0.422	0.355	0.347	0.446	1.367	0.228	
2011					0.72	0.087	1.094	0.089			0.543	0.171	0.355	0.238	0.842	0.421	0.902	0.306	1.034	0.232	
2012					0.624	0.091	1.492	0.089			1.079	0.173	0.581	0.198	0.246	0.29	3.648	0.243	0.907	0.247	
2013					0.782	0.09	0.958	0.09			0.93	0.173	0.745	0.211	1.019	0.314	0.432	0.385	0.548	0.291	
2014					0.624	0.094	0.901	0.094			0.883	0.181	0.539	0.279	1.606	0.235	0.316	0.458	0.659	0.256	
2015					0.587	0.091	0.824	0.094			0.95	0.183	1.16	0.207	0.635	0.27	0.252	0.56	0.624	0.259	
2016					0.479	0.095	1.198	0.094			1.187	0.179	1.372	0.179	4.133	0.273	0.655	0.361	0.639	0.299	
2017					0.649	0.094	0.963	0.087			0.751	0.189	1.33	0.203	1.808	0.227	0.311	0.435	0.474	0.303	
2018					0.58	0.093	0.921	0.092			1.094	0.191	0.871	0.178	0.921	0.296	0.081	2.716	0.793	0.242	
2019					0.386	0.11	0.546	0.114			1.113	0.183	0.333	0.243	0.892	0.417	0.856	0.313	0.443	0.343	
2020					0.758	0.104	0.445	0.112			0.862	0.181	1.093	0.163			0.474	0.422	0.586	0.287	
2021					0.615	0.106	0.527	0.117			0.639	0.187	1.123	0.2	0.853	0.24	2.275	0.252	1.044	0.227	
2022					0.877	0.098	1.533	0.099			0.543	0.197	1.908	0.207	0.721	0.232					

**Table 32. Fixed stations sampled by year as part of the SCDNR rotenone survey. Collections sites are arranged via estuary, from the South to the North.**

Estuary	St. Helena Sound / ACE Basin		North Edisto & Stono		Charleston Harbor									
River	Coosaw River		South Edisto	North Edisto	Stono	Ashley	Wando						Isle of Palms Sounds	
Year	Brickyard Creek	Triple Creek	South Edisto	Tom Post Creek	Stono River	Orange Grove Creek	Beresford Creek	Deep Creek	Foster Creek	Horlbeck Creek	Lachicotte Creek	Pita Creek	Wards Bridge	Inlet Creek
1986							7				7	7		7
1987	1	7	5	1	5	1	8				8	12		8
1988		7	7		7							7		
1989							1	7	10		10	9	1	
1990								12	12		12	12		
1991								13	12		12	12		
1992								6	6	1	6	6		
1993								4	4		4	4		
1994								4	4		4	4		
<b>Total</b>	<b>1</b>	<b>14</b>	<b>12</b>	<b>1</b>	<b>12</b>	<b>1</b>	<b>16</b>	<b>46</b>	<b>48</b>	<b>1</b>	<b>63</b>	<b>73</b>	<b>1</b>	<b>15</b>

**Table 33. Summary of life history information collected via the SCDNR during fishery-independent and fishery-dependent sampling program efforts. Bold #s represent years or sample sizes. Only sample sizes, by sex and maturity status where indicated, are provided for sex and maturity status. All lengths in mm, all weights in g, and all ages in yrs. Age-Length = ages determined based on length at capture and capture month; Age-Otolith = ages determined by otolith thin section aging techniques.**

Variable	Fishery-Independent Data						Fishery-Dependent Data				Total
	Rotenone	Stop Net	Trammel Net	Electrofishing	Longline - Historic	Longline - Contemporary	Misc.	Tournament	Freezer	SFS	
<b>Years</b>	<b>1986-1994</b>	<b>1985-1998</b>	<b>1987-2023</b>	<b>2001-2023</b>	<b>1994-2009</b>	<b>2007-2022</b>	<b>1994-1997</b>	<b>1986-2022</b>	<b>1995-2022</b>	<b>1988-2022</b>	<b>1985-2023</b>
<b>Fishing Years</b>	<b>1985-1993</b>	<b>1984-1987</b>	<b>1986-2023</b>	<b>2000-2023</b>	<b>1994-2009</b>	<b>2007-2022</b>	<b>1994-1997</b>	<b>1986-2022</b>	<b>1995-2022</b>	<b>1987-2021</b>	<b>1984-2023</b>
<b>Red Drum</b>	<b>1,679</b>	<b>8,121</b>	<b>85,858</b>	<b>15,664</b>	<b>3,709</b>	<b>8,659</b>	<b>4,643</b>	<b>1,023</b>	<b>2,283</b>	<b>11,487</b>	<b>143,126</b>
<b>Total Length</b>	<b>1,588</b>	<b>8,107</b>	<b>85,536</b>	<b>15,659</b>	<b>3,689</b>	<b>8,593</b>	<b>4,632</b>	<b>1,021</b>	<b>2,275</b>	<b>2,814</b>	<b>133,914</b>
Range	5-489	33-910	152-1,130	19-952	507-1,246	571-1,223	158-977	277-1,150	343-810	294-680	5-1,223
$\bar{X} \pm SE$	49 ± 1.4	432 ± 1.8	535 ± 0.6	416 ± 1.0	971 ± 1.3	954 ± 0.9	526 ± 2.2	551 ± 4.5	484 ± 1.7	458 ± 1.1	-
<b>Midline Length</b>	-	<b>24</b>	<b>3,390</b>	<b>18</b>	<b>3,687</b>	<b>8,494</b>	-	<b>26</b>	<b>202</b>	<b>8,673</b>	<b>24,514</b>
Range	-	339-730	215-982	270-746	491-1,154	534-1,145	-	358-642	348-670	220-1,361	220-1,361
$\bar{X} \pm SE$	-	444 ± 23.0	543 ± 2.5	488 ± 31.3	908 ± 1.2	891 ± 0.8	-	458 ± 16.5	452 ± 5.6	457 ± 0.9	-
<b>Standard Length</b>	<b>1,679</b>	<b>1,023</b>	<b>33,519</b>	<b>11,119</b>	<b>106</b>	<b>8,659</b>	<b>230</b>	<b>1,109</b>	<b>2,236</b>	-	<b>59,680</b>
Range	4-398	26-673	123-955	15-790	655-989	577-1,005	127-713	225-920	283-669	-	4-1,005
$\bar{X} \pm SE$	38 ± 1.1	241 ± 3.1	385 ± 0.8	323 ± 1.1	749 ± 4.6	793 ± 0.8	361 ± 6.2	452 ± 5.7	396 ± 3.4	-	-
<b>Weight (g)</b>	<b>722</b>	<b>806</b>	<b>3,554</b>	<b>818</b>	<b>105</b>	<b>8,659</b>	<b>160</b>	<b>986</b>	<b>5</b>	-	<b>15,815</b>
Range	1-1,261	1-5,950	95-8,850	1-7,000	5,000-17,070	1,110-26,500	259-7,500	279-14,629	862-4,042	-	1-26,500
$\bar{X} \pm SE$	22 ± 2.27	507 ± 28.2	1,513 ± 23.1	1,086 ± 32.4	7,687 ± 168.6	8,212 ± 23.0	1,105 ± 79.31	2,094 ± 43.33	1,931 ± 28.5	-	-
<b>Age-Length</b>	<b>1,581</b>	<b>5,251</b>	<b>34,912</b>	<b>11,374</b>	-	-	<b>2,098</b>	<b>161</b>	<b>859</b>	-	<b>56,236</b>
Range	0.00-1.00	0.2-2.17	0.75-2.67	0.08-2.75	-	-	0.75-2.17	1.08-2.00	1.00-2.25	-	0.00-2.75
X-bar +/-SE	0.29 ± 0.01	1.21 ± 0.00	1.30 ± 0.00	1.36 ± 0.00	-	-	1.35 ± 0.01	1.45 ± 0.03	1.47 ± 0.01	-	-
<b>Age-Otolith</b>	<b>6</b>	<b>154</b>	<b>2,055</b>	<b>224</b>	<b>106</b>	<b>1,361</b>	<b>51</b>	<b>829</b>	<b>1,369</b>	-	<b>6,155</b>
Range	0.92-1.92	1.08-3.83	0.75-22.17	0.83-5.08	3.17-32.67	3.00-40.25	1.58-3.83	0.92-41.08	0.92-5.08	-	0.83-41.08
$\bar{X} \pm SE$	1.08 ± 0.17	2.16 ± 0.05	2.49 ± 1.07	2.25 ± 0.05	8.92 ± 5.50	15.84 ± 0.22	2.55 ± 0.09	2.77 ± 0.12	2.12 ± 0.01	-	-
<b>Sex</b>	-	-	<b>674</b>	<b>193</b>	<b>16</b>	<b>1,171</b>	-	<b>46</b>	<b>4</b>	-	<b>2,104</b>
Female	-	-	320	105	9	673	-	25	3	-	1,135
Male	-	-	337	84	7	495	-	20	1	-	944
Unknown	-	-	17	4	-	3	-	1	-	-	25
<b>Maturity Status</b>	-	-	<b>674</b>	<b>189</b>	<b>16</b>	<b>1,168</b>	-	<b>45</b>	<b>4</b>	-	<b>2,096</b>
Female	-	-	320	105	9	673	-	25	3	-	1,135
Immature	-	-	275	100	1	45	-	24	3	-	448
Mature	-	-	44	74	8	626	-	1	-	-	753
Unknown	-	-	1	-	-	2	-	-	-	-	3
Male	-	-	337	84	7	495	-	20	1	-	944
Immature	-	-	219	74	-	12	-	13	1	-	319
Mature	-	-	116	10	7	483	-	7	-	-	623
Unknown	-	-	2	-	-	-	-	-	-	-	2

\* - Histology only derived sex and maturity information

**Table 34. Size distribution by month of red drum encountered by the SCDNR rotenone survey. The year is aligned to start with August, the first month in which newly born red drum recruit to the gear in South Carolina. Green shaded cells represent age-0 red drum monthly throughout the year. Note, very few age-1+ red drum (denoted by pink shaded cells) are encountered by this survey, with those individuals only captured during the months of August and July.**

TL (mm)	Month												Total
	Aug.	Sept.	Oct.	Nov.	Dec.	Jan.	Feb.	Mar.	Apr.	May	Jun.	Jul.	
475	0	0	0	0	0	0	0	0	0	0	0	1	1
450	0	0	0	0	0	0	0	0	0	0	0	0	0
425	0	0	0	0	0	0	0	0	0	0	0	0	0
400	0	0	0	0	0	0	0	0	0	0	0	0	0
375	0	0	0	0	0	0	0	0	0	0	0	0	0
350	0	0	0	0	0	0	0	0	0	0	0	0	0
325	0	0	0	0	0	0	0	0	0	0	0	1	1
300	2	0	0	0	0	0	0	0	0	0	0	0	2
275	2	0	0	0	0	0	0	0	0	0	0	2	4
250	0	0	0	0	0	0	0	0	0	0	1	2	3
225	0	0	0	0	0	0	0	0	0	0	0	6	6
200	0	0	0	0	0	0	0	0	0	0	11	2	13
175	0	0	0	0	0	0	0	0	0	10	41	1	52
150	0	0	0	0	0	0	0	0	3	14	50	0	67
125	0	0	0	0	0	0	0	0	17	34	9	0	60
100	0	0	0	0	0	0	0	0	26	16	0	0	42
75	0	0	0	34	6	1	5	20	39	1	0	0	106
50	0	0	1	27	42	2	28	29	9	0	0	0	138
25	0	18	65	141	46	7	6	4	0	0	0	0	287
0	75	608	202	12	0	0	0	0	0	0	0	0	897
<b>Total</b>	<b>79</b>	<b>626</b>	<b>268</b>	<b>214</b>	<b>94</b>	<b>10</b>	<b>39</b>	<b>53</b>	<b>94</b>	<b>75</b>	<b>112</b>	<b>15</b>	<b>1679</b>

**Table 35. SCDNR rotenone survey standardized index of year class relative abundance. RSE = relative standard error; lower and upper refer to the lower and upper bounds of a 95% CI as estimated using estimated marginal means. CPUE refers to the index on the catch scale; Relative abundance is the index and confidence intervals normalized to the mean index value over all years of the survey.**

Year Class	Collections	% Positive	Red Drum	CPUE Index					Relative Abundance		
				CPUE	SE	RSE	Lower	Upper	Index	Lower	Upper
1985	8	50.00%	9	3.52	2.694	0.766	0.78	15.88	1.09	0.24	4.94
1986	49	67.35%	561	7.02	2.982	0.425	3.04	16.20	2.18	0.95	5.03
1987	46	54.35%	169	4.05	1.828	0.452	1.66	9.85	1.26	0.52	3.06
1988	15	33.33%	12	1.17	0.747	0.639	0.33	4.11	0.36	0.10	1.28
1989	50	44.00%	247	2.04	0.930	0.456	0.83	5.01	0.63	0.26	1.56
1990	47	72.34%	455	5.66	2.724	0.481	2.20	14.60	1.76	0.68	4.54
1991	44	54.55%	287	2.24	1.107	0.495	0.84	5.93	0.69	0.26	1.84
1992	16	37.50%	8	0.70	0.453	0.651	0.19	2.51	0.22	0.06	0.78
1993	16	43.75%	27	2.57	1.463	0.570	0.84	7.88	0.80	0.26	2.45



**Table 36. Fixed stations sampled by year as part of the SCDNR stop net survey. Collections sites are arranged via South Carolina estuary, from the South to the North. Note, year represents calendar year (Jan. 1 – Dec. 31) though the index was developed using fishing years (Sept. 1 – Aug. 31). Gray shaded cells are the years and sites considered for initial index development, prior to subsequent sub-sampling based on availability of other covariate information.**

Year	Port Royal Sound		Triple Creek*	Charleston Harbor			Bulls Bay		Town Creek^	Total
	Callawassie Creek	Turtle Creek		Crab Bank	Ft. Sumter	Grice Cove	Anderson Creek	Bulls Island		
1985	-	-	-	-	-	1	-	-	-	1
1986	-	-	-	-	-	6	-	-	-	6
1987	-	-	1	1	-	14	-	-	-	16
1988	-	-	-	-	1	13	-	-	-	14
1989	4	2	-	-	5	13	1	1	1	27
1990	-	1	-	-	-	12	-	7	-	20
1991	-	-	-	-	-	13	-	4	-	17
1992	-	-	-	-	-	13	-	4	-	17
1993	-	-	-	-	-	12	-	5	-	17
1994	-	-	-	-	-	9	-	2	-	11
1995	-	-	-	-	-	1	-	-	-	1
1996	-	-	-	-	-	1	-	1	-	2
1997	-	-	-	-	-	-	-	-	-	0
1998	-	-	-	-	-	1	-	-	-	1
<b>Total</b>	<b>4</b>	<b>3</b>	<b>1</b>	<b>1</b>	<b>6</b>	<b>109</b>	<b>1</b>	<b>24</b>	<b>1</b>	<b>150</b>

\* - St. Helena Sound / ACE Basin

^ - North Inlet

**Table 37. SCDNR stop net survey standardized index of relative abundance. RSE = relative standard error; lower and upper refer to the lower and upper bounds of a 95% CI as estimated using estimated marginal means. CPUE refers to the index on the catch scale; Relative abundance is the index and confidence intervals normalized to the mean index value over all years of the survey.**

Fishing Year	Collections	% Positive	Red Drum	CPUE Index			Relative Abundance				
				CPUE	SE	RSE	Lower	Upper	Index	Lower	Upper
1986	13	92.31%	633	28.38	7.925	0.279	16.32	49.35	0.81	0.46	1.40
1987	13	92.31%	905	38.86	10.830	0.279	22.37	67.50	1.11	0.64	1.92
1988	13	100.00%	842	35.77	10.262	0.287	20.26	63.15	1.02	0.58	1.80
1989	19	94.74%	1051	31.21	8.103	0.260	18.65	52.20	0.89	0.53	1.49
1990	18	100.00%	977	34.07	8.304	0.244	21.02	55.22	0.97	0.60	1.57
1991	17	100.00%	1263	43.63	10.870	0.249	26.63	71.48	1.24	0.76	2.03
1992	16	100.00%	956	36.95	9.165	0.248	22.60	60.41	1.05	0.64	1.72
1993	15	100.00%	777	32.25	8.542	0.265	19.08	54.51	0.92	0.54	1.55

**Table 38. Fishing years (and months within years) individual contemporary strata have been sampled as part of the SCDNR trammel net survey since 1990. Shaded cells include the years (and months) included in the development of relative abundance indices for individual species.**

Fishing Year	Port Royal Sound <sup>a</sup>		St. Helena Sound	Charleston Harbor			Cape Romain <sup>b</sup>			Winyah bay
	CT	BR	AB	AR	CH	LW	CR	MB	RH	WB
1990	-	-	June	Nov	Nov-Aug	Nov-Aug	Feb-Apr	-	Feb-Apr	-
1991	-	-	-	Jul-Aug	Sept-Aug	Sept-Aug	-	-	-	-
1992	-	-	-	Jan-Aug	Sept-Aug	Sept-Aug	-	-	-	Oct-Aug
1993	Aug	-	Jan-Aug	Sept-Aug	Sept-Aug	Sept-Aug	Jan-Aug	Oct-Nov	Oct-Jul	Sept-June
1994	Oct-Dec	-	Sept-Aug	Sept-Aug	Sept-Aug	Sept-Aug	Sept-Aug	Aug	Oct-Aug	-
1995	-	-	Sept-Aug	Sept-Aug	Sept-Aug	Sept-Aug	Sept-Aug	July-Aug	July-Aug	-
1996	June-Aug	-	Sept-Aug	Sept-Aug	Sept-Aug	Sept-Aug	Sept-Aug	Sept-Aug	Sept-Aug	-
1997	Sept-July	Oct-Aug	Sept-Aug	Sept-Aug	Sept-Aug	Sept-Aug	-	Sept-Aug	Sept-Aug	-
1998	Sept-Mar	Oct-Mar	Sept-Aug	Sept-Aug	Sept-Aug	Sept-Aug	-	Sept-Aug	Sept-Aug	-
1999	-	-	Sept-Aug	Sept-Aug	Sept-Aug	Sept-Aug	-	Sept-Aug	Sept-Aug	-
2000	-	-	Sept-Aug	Sept-Aug	Sept-Aug	Sept-Aug	-	Sept-Aug	Sept-Aug	June
2001	-	-	Sept-Aug	Sept-Aug	Sept-Aug	Sept-Aug	-	Sept-Aug	Sept-Aug	July-Aug
2002	June	-	Sept-Aug	Sept-Aug	Sept-Aug	Sept-Aug	-	Sept-Aug	Sept-Aug	Jan-Aug
2003	-	-	Sept-Aug	Sept-Aug	Sept-Aug	Sept-Aug	-	Sept-Aug	Sept-Aug	Sept-Aug
2004	-	-	Sept-Aug	Sept-Aug	Sept-Aug	Sept-Aug	-	Sept-Aug	Sept-Aug	Sept-Aug
2005	-	-	Sept-Aug	Sept-Aug	Sept-Aug	Sept-Aug	-	Sept-Aug	Sept-Aug	Sept-Aug
2006	-	-	Sept-Aug	Sept-Aug	Sept-Aug	Sept-Aug	-	Sept-Aug	Sept-Aug	Sept-Aug
2007	-	-	Sept-Aug	Sept-Aug	Sept-Aug	Sept-Aug	-	Sept-Aug	Sept-Aug	Sept-Aug
2008	Aug	Aug	Sept-Aug	Sept-Aug	Sept-Aug	Sept-Aug	-	Sept-Aug	Sept-Aug	Sept-Aug
2009	Sept-Aug	Sept-Aug	Sept-Aug	Sept-Aug	Sept-Aug	Sept-Aug	-	Sept-Aug	Sept-Aug	Sept-Aug
2010	Sept-Aug	Sept-Aug	Sept-Aug	Sept-Aug	Sept-Aug	Sept-Aug	-	Sept-Aug	Sept-Aug	Sept-Aug
2011	Sept-Aug	Sept-Aug	Sept-Aug	Sept-Aug	Sept-Aug	Sept-Aug	-	Sept-Aug	Sept-Aug	Sept-Aug
2012	Sept-Aug	Sept-Aug	Sept-Aug	Sept-Aug	Sept-Aug	Sept-Aug	-	Sept-Aug	Sept-Aug	Sept-Aug
2013	Sept-Aug	Sept-Aug	Sept-Aug	Sept-Aug	Sept-Aug	Sept-Aug	-	Sept-Aug	Sept-Aug	Sept-Aug
2014	Sept-Aug	Sept-Aug	Sept-Aug	Sept-Aug	Sept-Aug	Sept-Aug	-	Sept-Aug	Sept-Aug	Sept-Aug
2015	Sept-Aug	Sept-Aug	Sept-Aug	Sept-Aug	Sept-Aug	Sept-Aug	-	Sept-Aug	Sept-Aug	Sept-Aug
2016	Sept-Aug	Sept-Aug	Sept-Aug	Sept-Aug	Sept-Aug	Sept-Aug	-	Sept-Aug	Sept-Aug	Sept-Aug

Estuary	Port Royal Sound <sup>a</sup>		St. Helena Sound	Charleston Harbor			Cape Romain <sup>b</sup>			Winyah bay
	CT	BR	AB	AR	CH	LW	CR	MB	RH	WB
2017	Sept-Aug	Sept-Aug	Sept-Aug	Sept-Aug	Sept-Aug	Sept-Aug	-	Sept-Aug	Sept-Aug	Sept-Aug
2018	Sept-Aug	Sept-Aug	Sept-Aug	Sept-Aug	Sept-Aug	Sept-Aug	-	Sept-Aug	Sept-Aug	Sept-Aug
2019 <sup>c,d</sup>	Sept-Aug	Sept-Aug	Sept-Aug	Sept-Aug	Sept-Aug	Sept-Aug	-	Sept-Aug	Sept-Aug	Sept-Aug
2020 <sup>c,d</sup>	Sept-Aug	Sept-Aug	Sept-Aug	Sept-Aug	Sept-Aug	Sept-Aug	-	Sept-Aug	Sept-Aug	Sept-Aug
2021 <sup>d</sup>	Sept-Aug	Sept-Aug	Sept-Aug	Sept-Aug	Sept-Aug	Sept-Aug	-	Sept-Aug	Sept-Aug	Sept-Aug
2022 <sup>d</sup>	Sept-Aug	Sept-Aug	Sept-Aug	Sept-Aug	Sept-Aug	Sept-Aug	-	Sept-Aug	Sept-Aug	Sept-Aug

<sup>a</sup> - Only quarterly sampling occurred in Port Royal Sound through June 2020 with two strata being defined and sampled, Colleton River (CT) and Broad River (BR)

<sup>b</sup> - The Cape Romain strata has undergone revision through time. From calendar year 1994-1996 there was a single stratum sampled, referred to as the Cape Romain (CR) stratum; from 1997 thru June 2020, two strata were sampled monthly, called Muddy & Bulls Bay (MB) and Romain Harbor (RH), with both strata being expansions of the original geographic footprint of the original Cape Romain strata (original stations became seed members of the two new strata with additional stations created. This splitting of strata was necessary due to safety concerns and the geographic footprint of the original strata (too large of an area for field crews to safely support each other in the field).

<sup>c</sup> - Sampling in 2020 was affected due to social distancing protocols put into place due to COVID-19 as well as a survey design change that was implemented in July 2020 (see below for details). Sampling was halted midway through March 2020 monthly sampling, with no sampling in April-June. Sampling resumed in July, but was limited through August, with sampling under the new survey intensity fully implemented in September 2020

<sup>d</sup> - To ensure financial solvency of the survey while maintaining the continuity of the long-term survey, the sampling intensity of the survey was modified in July 2020. Changes included 1) a merging of the traditional Colleton River and Broad River strata in Port Royal Sound into the combined Port Royal Sound Stratum, 2) a merging of the traditional Muddy & Bulls Bay (MB) and Romain Harbor (RH) strata into the combined Cape Romain stratum with only stations in either the traditional MB or RH stratum selected for sampling in a given sampling month, and 3) moving to sampling the remaining seven strata twice per quarter instead of the traditional monthly sampling employed in most strata prior (increased frequency of within year sampling in Port Royal Sound; decreased frequency of within year sampling in other strata).

**Table 39. By fishing year, number of trammel net collections made in the contemporary strata. Shown is the total number of collections, including those not deemed suitable for index development but useful for collection of life history samples, and the number of collections retained for index development (in parentheses).**

Fishing Year	Port Royal Sound		St. Helena Sound	Charleston Harbor			Cape Romain			Winyah bay	Total
	CT	BR	AB	AR	CH	LW	CR	MB	RH	WB	
1990	-	-	1 (0)	4 (0)	76 (40)	131 (54)	19 (0)	-	4 (0)	-	<b>235 (94)</b>
1991	-	-	-	1'-	57 (55)	106 (93)	-	-	-	-	<b>173 (148)</b>
1992	-	-	-	108 (71)	62 (59)	119 (117)	-	-	-	3'-	<b>319 (247)</b>
1993	1 (0)	-	70 (64)	122 (115)	80 (76)	118 (111)	61 (57)	15 (0)	20 (5)	24 (0)	<b>511 (428)</b>
1994	2 (0)	-	143 (123)	167 (141)	131 (116)	151 (136)	137 (114)	2 (2)	6 (6)	-	<b>739 (638)</b>
1995	-	-	147 (139)	156 (144)	135 (131)	141 (132)	141 (137)	4 (4)	8 (8)	-	<b>732 (695)</b>
1996	5 (0)	-	154 (146)	179 (172)	164 (163)	154 (146)	119 (117)	34 (22)	37 (35)	-	<b>846 (801)</b>
1997	12 (0)	13 (0)	155 (154)	166 (163)	209 (176)	143 (140)	-	138 (110)	137 (129)	-	<b>973 (872)</b>
1998	6 (0)	7 (0)	153 (150)	168 (164)	227 (182)	171 (166)	-	166 (166)	143 (142)	-	<b>1041 (970)</b>
1999	-	-	151 (149)	160 (156)	227 (159)	145 (142)	-	143 (143)	149 (149)	-	<b>975 (898)</b>
2000	-	-	131 (128)	163 (163)	133 (131)	136 (136)	-	127 (126)	134 (134)	1 (0)	<b>825 (818)</b>
2001	-	-	153 (152)	162 (162)	141 (136)	153 (149)	-	129 (127)	137 (137)	11 (0)	<b>886 (863)</b>
2002	4 (0)	-	135 (134)	161 (161)	125 (123)	135 (135)	-	125 (124)	124 (123)	105 (72)	<b>914 (872)</b>
2003	-	-	128 (128)	164 (164)	133 (131)	138 (137)	-	136 (136)	144 (144)	119 (118)	<b>962 (958)</b>
2004	-	-	141 (141)	156 (156)	133 (128)	136 (135)	-	139 (139)	143 (143)	129 (127)	<b>977 (969)</b>
2005	-	-	126 (123)	165 (163)	129 (127)	136 (134)	-	141 (141)	128 (128)	136 (136)	<b>961 (952)</b>
2006	-	-	120 (118)	159 (157)	123 (121)	142 (140)	-	123 (123)	136 (136)	120 (120)	<b>923 (915)</b>
2007	-	-	132 (131)	173 (156)	126 (126)	143 (141)	-	141 (141)	120 (119)	125 (125)	<b>960 (939)</b>
2008	14 (0)	11 (0)	121 (119)	149 (148)	112 (110)	131 (130)	-	132 (131)	125 (125)	108 (107)	<b>903 (870)</b>
2009	52 (39)	52 (39)	137 (136)	159 (159)	126 (126)	130 (129)	-	113 (113)	140 (138)	94 (94)	<b>1003 (973)</b>
2010	50 (50)	45 (45)	148 (147)	153 (152)	135 (127)	138 (137)	-	121 (121)	151 (151)	122 (122)	<b>1063 (1052)</b>
2011	44 (43)	49 (49)	150 (150)	157 (156)	134 (127)	125 (125)	-	139 (139)	151 (151)	134 (132)	<b>1083 (1072)</b>
2012	47 (46)	31 (31)	135 (133)	145 (144)	124 (120)	131 (129)	-	120 (120)	123 (119)	111 (111)	<b>967 (953)</b>
2013	38 (38)	20 (20)	116 (116)	150 (148)	131 (122)	133 (131)	-	115 (115)	123 (123)	126 (126)	<b>952 (939)</b>
2014	13 (13)	12 (12)	123 (121)	144 (144)	121 (119)	131 (128)	-	111 (111)	126 (126)	115 (115)	<b>896 (889)</b>
2015	44 (42)	40 (39)	123 (122)	145 (142)	121 (120)	135 (130)	-	127 (125)	125 (124)	119 (118)	<b>979 (962)</b>
2016	31 (30)	26 (25)	122 (119)	138 (128)	113 (109)	119 (115)	-	101 (99)	120 (119)	134 (127)	<b>904 (871)</b>
2017	44 (42)	33 (32)	111 (104)	128 (123)	99 (95)	111 (108)	-	110 (106)	130 (128)	126 (123)	<b>892 (861)</b>
2018	42 (41)	40 (39)	113 (108)	141 (140)	110 (108)	121 (118)	-	126 (124)	128 (127)	129 (129)	<b>950 (934)</b>
2019	30 (30)	30 (30)	84 (81)	102 (101)	86 (84)	96 (94)	-	84 (84)	69 (69)	83 (82)	<b>664 (655)</b>
2020	50 (48)	43 (42)	93 (92)	94 (94)	87 (86)	91 (90)	-	45 (44)	56 (56)	90 (89)	<b>649 (641)</b>
2021	40 (36)	41 (41)	99 (98)	93 (91)	91 (89)	87 (86)	-	39 (39)	47 (45)	92 (91)	<b>629 (616)</b>
2022	79 (77)	84 (84)	71 (70)	100 (100)	68 (67)	95 (91)	-	67 (66)	79 (77)	97 (97)	<b>740 (729)</b>
<b>Total</b>	<b>648 (575)</b>	<b>577 (528)</b>	<b>3,786 (3,696)</b>	<b>4,541 (4,378)</b>	<b>4,069 (3,789)</b>	<b>4,272 (4,085)</b>	<b>477 (425)</b>	<b>3,113 (3,041)</b>	<b>3,263 (3,216)</b>	<b>2,480 (2,361)</b>	<b>27,226 (26,094)</b>

**Table 40. SCDNR trammel net survey standardized index of relative abundance. RSE = relative standard error; lower and upper refer to the lower and upper bounds of a 95% CI as estimated using estimated marginal means. CPUE refers to the index on the catch scale; Relative abundance is the index and confidence intervals normalized to the mean index value over all years of the survey.**

Year	Collections	% Positive	Red Drum	CPUE Index				Relative Abundance			
				CPUE	SE	RSE	Lower	Upper	Index	Lower	Upper
1991	147	63.27%	1,286	3.10	0.542	0.175	2.20	4.36	2.44	1.73	3.44
1992	244	53.69%	1,530	2.27	0.310	0.137	1.73	2.97	1.79	1.37	2.34
1993	416	55.29%	2,766	2.19	0.246	0.113	1.76	2.73	1.73	1.39	2.15
1994	630	49.21%	2,208	1.31	0.132	0.100	1.08	1.59	1.03	0.85	1.26
1995	688	47.53%	3,402	1.88	0.181	0.096	1.56	2.27	1.48	1.23	1.79
1996	794	44.96%	3,034	1.15	0.109	0.095	0.95	1.38	0.91	0.75	1.09
1997	868	45.62%	2,567	1.05	0.095	0.090	0.88	1.26	0.83	0.70	0.99
1998	967	40.23%	2,451	0.83	0.074	0.090	0.69	0.99	0.65	0.55	0.78
1999	892	37.00%	1,543	0.63	0.059	0.093	0.53	0.76	0.50	0.42	0.60
2000	816	42.52%	2,890	1.32	0.122	0.092	1.10	1.59	1.04	0.87	1.25
2001	859	53.32%	3,626	1.60	0.142	0.089	1.35	1.91	1.26	1.06	1.50
2002	871	51.32%	4,268	1.79	0.158	0.088	1.50	2.12	1.41	1.19	1.68
2003	956	56.17%	5,385	2.08	0.177	0.085	1.76	2.45	1.64	1.39	1.94
2004	969	52.53%	4,220	1.88	0.162	0.086	1.59	2.22	1.48	1.25	1.75
2005	950	50.84%	4,052	1.66	0.144	0.087	1.40	1.96	1.31	1.10	1.55
2006	915	41.64%	2,233	0.87	0.078	0.091	0.73	1.03	0.68	0.57	0.82
2007	938	44.46%	2,862	1.08	0.096	0.089	0.90	1.28	0.85	0.71	1.01
2008	869	45.91%	2,897	1.19	0.107	0.090	1.00	1.42	0.94	0.79	1.12
2009	959	46.09%	3,731	1.63	0.141	0.087	1.37	1.93	1.28	1.08	1.52
2010	1,048	46.09%	3,743	1.34	0.115	0.086	1.13	1.58	1.05	0.89	1.25
2011	1,067	37.86%	2,520	0.91	0.079	0.087	0.77	1.08	0.72	0.61	0.85
2012	953	34.73%	1,894	0.79	0.072	0.091	0.66	0.94	0.62	0.52	0.75
2013	938	38.49%	2,097	0.99	0.090	0.090	0.83	1.18	0.78	0.65	0.93
2014	889	31.95%	1,258	0.79	0.074	0.094	0.66	0.95	0.62	0.52	0.75
2015	959	31.80%	1,513	0.74	0.068	0.091	0.62	0.89	0.59	0.49	0.70
2016	870	31.72%	1,149	0.61	0.058	0.096	0.50	0.73	0.48	0.40	0.58
2017	857	28.24%	1,496	0.82	0.078	0.094	0.68	0.99	0.65	0.54	0.78
2018	933	31.08%	1,443	0.73	0.068	0.093	0.61	0.88	0.58	0.48	0.70
2019	654	23.70%	535	0.49	0.054	0.110	0.39	0.61	0.39	0.31	0.48
2020	636	37.89%	1,090	0.96	0.100	0.104	0.78	1.18	0.76	0.62	0.93
2021	614	31.92%	896	0.78	0.083	0.107	0.63	0.96	0.62	0.50	0.76
2022	722	38.78%	1,687	1.11	0.110	0.099	0.92	1.35	0.88	0.72	1.06

**Table 41. Fixed stations sampled by year as part of the SCDNR historic longline survey that were considered during index development. Collection sites are arranged from inshore to offshore North. Given the seasonal nature of the survey, collections made from August-December in a given calendar year (Year) was used to represent adult red drum abundance during that fishing year (e.g., fishing year = calendar year for survey).**

<b>Year</b>	<b>South Jetties</b>	<b>North Jetties</b>	<b>Old C-6</b>	<b>Humps</b>	<b>2 Charlie</b>	<b>Total</b>
1994	-	-	58	-	-	<b>58</b>
1995	-	-	86	-	-	<b>86</b>
1996	-	-	99	-	13	<b>112</b>
1997	-	-	93	-	12	<b>105</b>
1998	-	-	74	30	9	<b>113</b>
1999	-	-	65	14	23	<b>102</b>
2000	-	22	42	13	9	<b>86</b>
2001	-	27	36	15	15	<b>93</b>
2002	14	37	16	8	6	<b>81</b>
2003	24	21	36	8	2	<b>91</b>
2004	24	12	34	3	5	<b>78</b>
2005	15	8	4	-	1	<b>28</b>
2006	26	21	3	-	-	<b>50</b>
<b>Total</b>	<b>103</b>	<b>148</b>	<b>646</b>	<b>91</b>	<b>95</b>	<b>1,083</b>

**Table 42. SCDNR historic longline survey standardized index of relative abundance. RSE = relative standard error; lower and upper refer to the lower and upper bounds of a 95% CI as estimated using estimated marginal means. CPUE refers to the index on the catch scale, in this case catch per 120 hooks; Relative abundance is the index and confidence intervals normalized to the mean index value over all years of the survey.**

Year	Collections	% Positive	CPUE Index			Relative Abundance				
			CPUE	SE	RSE	Lower	Upper	Index	Lower	Upper
1994	58	44.83%	4.53	0.940	0.208	3.01	6.81	1.11	0.74	1.67
1995	86	54.65%	5.41	0.991	0.183	3.78	7.75	1.33	0.93	1.90
1996	112	58.93%	4.84	0.773	0.160	3.54	6.63	1.19	0.87	1.63
1997	105	44.76%	2.01	0.375	0.186	1.40	2.90	0.49	0.34	0.71
1998	113	53.10%	3.24	0.539	0.166	2.34	4.49	0.80	0.57	1.10
1999	102	73.53%	4.98	0.826	0.166	3.60	6.90	1.22	0.88	1.69
2000	86	56.98%	2.77	0.481	0.174	1.97	3.89	0.68	0.48	0.95
2001	93	69.89%	4.11	0.667	0.162	2.99	5.65	1.01	0.73	1.39
2002	81	77.78%	4.77	0.829	0.174	3.39	6.71	1.17	0.83	1.65
2003	91	83.52%	5.45	0.897	0.165	3.94	7.52	1.34	0.97	1.85
2004	78	65.38%	3.69	0.645	0.175	2.62	5.20	0.90	0.64	1.28
2005	28	67.86%	4.56	1.502	0.329	2.39	8.70	1.12	0.59	2.13
2006	50	64.00%	2.62	0.626	0.238	1.64	4.19	0.64	0.40	1.03



**Table 43. Fishing years (and months within years) individual contemporary strata have been sampled as part of the SCDNR electrofishing survey since 2000.**

Fishing Year	St. Helena Sound		Charleston Harbor		Winyah bay
	Combahee River	Edisto River	Ashley River	Cooper River	Waccamaw/Sampit Rivers
2000	Apr-Aug	Mar-Aug	Feb-Aug	Mar-Aug	-
2001	Sept-Aug	Sept-Aug	Sept-Aug	Sept-Aug	-
2002	Sept-Aug	Sept-Aug	Sept-Aug	Sept-Aug	-
2003	Sept-Aug	Sept-Aug	Sept-Aug	Sept-Aug	Sept-Aug
2004	Sept-Aug	Sept-Aug	Sept-Aug	Sept-Aug	Sept-Aug
2005	Sept-Aug	Sept-Aug	Sept-Aug	Sept-Aug	Sept-Aug
2006	Sept-Aug	Sept-Aug	Sept-Aug	Sept-Aug	Sept-Aug
2007	Sept-Aug	Sept-Aug	Sept-Aug	Sept-Aug	Sept-Aug
2008	Sept-Aug	Sept-Aug	Sept-Aug	Sept-Aug	Sept-Aug
2009	Sept-Aug	Sept-Aug	Sept-Aug	Sept-Aug	Sept-Aug
2010	Sept-Aug	Sept-Aug	Sept-Aug	Sept-Aug	Sept-Aug
2011	Sept-Aug	Sept-Aug	Sept-Aug	Sept-Aug	Sept-Aug
2012	Sept-Aug	Sept-Aug	Sept-Aug	Sept-Aug	Sept-Aug
2013	Sept-Aug	Sept-Aug	Sept-Aug	Sept-Aug	Sept-Aug
2014	Sept-Aug	Sept-Aug	Sept-Aug	Sept-Aug	Sept-Aug
2015	Sept-Aug	Sept-Aug	Sept-Aug	Sept-Aug	Sept-Aug
2016	Sept-Aug	Sept-Aug	Sept-Aug	Sept-Aug	Sept-Aug
2017	Sept-Aug	Sept-Aug	Sept-Aug	Sept-Aug	Sept-Aug
2018	Sept-Aug	Sept-Aug	Sept-Aug	Sept-Aug	Sept-Aug
2019 <sup>a,b</sup>	Sept-Aug	Sept-Aug	Sept-Aug	Sept-Aug	Sept-Aug
2020 <sup>a,b</sup>	Sept-Aug	Sept-Aug	Sept-Aug	Sept-Aug	Sept-Aug
2021 <sup>b</sup>	Sept-Aug	Sept-Aug	Sept-Aug	Sept-Aug	Sept-Aug
2022 <sup>b</sup>	Sept-Aug	Sept-Aug	Sept-Aug	Sept-Aug	Sept-Aug

<sup>a</sup> - Sampling in 2020 was affected due to social distancing protocols put into place due to COVID-19 as well as a survey design change that was implemented in July 2020 (see below for details). Sampling was halted midway through March 2020 monthly sampling, with no sampling in April-May. Sampling resumed in June under a new survey intensity

<sup>b</sup> - To ensure financial solvency of the survey while maintaining the continuity of the long-term survey, the sampling intensity of the survey was modified in June 2020. Changes included moving from monthly sampling of each stratum, to sampling each stratum five of every six months (10 times annually).

**Table 44. By fishing year, number of electrofishing collections made in the contemporary strata.**

Estuary	St. Helena Sound		Charleston Harbor		Winyah bay	Total
	Combahee River	Edisto River	Ashley River	Cooper River	Waccamaw/Sampit Rivers	
2000	17	20	21	26		84
2001	63	67	73	68		271
2002	58	68	72	67		265
2003	62	53	65	73	47	300
2004	53	61	67	66	61	308
2005	58	59	65	71	59	312
2006	62	65	73	61	71	332
2007	61	50	62	67	42	282
2008	65	57	67	69	65	323
2009	66	64	67	70	59	326
2010	56	50	67	63	53	289
2011	71	62	69	65	64	331
2012	61	68	56	57	58	300
2013	56	61	67	67	64	315
2014	67	59	69	59	54	308
2015	66	52	67	62	66	313
2016	65	58	61	60	52	296
2017	62	63	82	78	56	341
2018	64	60	67	69	64	324
2019	49	36	47	52	51	235
2020	57	53	54	47	59	270
2021	48	60	37	49	52	246
2022	64	54	50	50	43	261
<b>Total</b>	<b>1,351</b>	<b>1,300</b>	<b>1,425</b>	<b>1,416</b>	<b>1,140</b>	<b>6,632</b>

**Table 45. SCDNR electrofishing survey standardized index of relative abundance. RSE = relative standard error; lower and upper refer to the lower and upper bounds of a 95% CI as estimated using estimated marginal means. CPUE refers to the index on the catch scale, in this case catch per 15 minutes electrofishing; Relative abundance is the index and confidence intervals normalized to the mean index value over all years of the survey.**

Year	Collections	% Positive	Red Drum	CPUE Index					Relative Abundance		
				CPUE	SE	RSE	Lower	Upper	Index	Lower	Upper
2001	250	59.60%	631	1.95	0.198	0.102	1.59	2.37	1.00	0.82	1.22
2002	253	62.45%	774	2.91	0.280	0.096	2.41	3.52	1.49	1.24	1.80
2003	292	58.56%	1,035	2.59	0.230	0.089	2.17	3.08	1.33	1.11	1.58
2004	299	55.52%	668	1.51	0.140	0.093	1.26	1.81	0.77	0.64	0.93
2005	303	52.81%	696	1.58	0.145	0.092	1.32	1.89	0.81	0.68	0.97
2006	322	51.55%	535	1.29	0.121	0.094	1.07	1.55	0.66	0.55	0.79
2007	264	58.33%	562	1.79	0.180	0.101	1.47	2.18	0.92	0.75	1.12
2008	310	60.32%	917	2.38	0.209	0.088	2.01	2.83	1.22	1.03	1.45
2009	317	58.99%	939	2.57	0.226	0.088	2.16	3.05	1.31	1.11	1.56
2010	280	59.64%	706	2.12	0.204	0.096	1.76	2.56	1.09	0.90	1.31
2011	323	58.20%	844	2.14	0.191	0.089	1.79	2.54	1.09	0.92	1.30
2012	294	57.48%	993	2.91	0.260	0.089	2.44	3.47	1.49	1.25	1.78
2013	310	53.23%	647	1.87	0.169	0.090	1.57	2.23	0.96	0.80	1.14
2014	297	47.81%	525	1.76	0.166	0.094	1.46	2.12	0.90	0.75	1.08
2015	300	49.00%	489	1.61	0.151	0.094	1.34	1.93	0.82	0.69	0.99
2016	284	57.39%	644	2.34	0.220	0.094	1.94	2.81	1.20	1.00	1.44
2017	339	61.06%	730	1.88	0.164	0.087	1.58	2.23	0.96	0.81	1.14
2018	311	50.80%	638	1.80	0.165	0.092	1.50	2.15	0.92	0.77	1.10
2019	220	39.55%	289	1.07	0.122	0.114	0.85	1.33	0.55	0.44	0.68
2020	260	38.46%	244	0.87	0.098	0.113	0.70	1.08	0.44	0.36	0.56
2021	228	42.98%	251	1.03	0.120	0.117	0.82	1.29	0.53	0.42	0.66
2022	244	64.34%	704	2.99	0.296	0.099	2.46	3.63	1.53	1.26	1.86

**Table 46. By year, number of SCDNR contemporary longline collections made. Shown is the total number of collections, including those not deemed suitable for index development but useful for collection of life history samples, and the number of collections retained for index development (in parentheses) by strata.**

Year	Port Royal Sound		St. Helena Sound		Charleston Harbor		Winyah Bay		Total		Combined
	Inshore	Offshore	Inshore	Offshore	Inshore	Offshore	Inshore	Offshore	Inshore	Offshore	
2007	49 (18)	38 (23)	52 (8)	47 (22)	34 (16)	50 (30)	35 (30)	46 (37)	<b>170 (72)</b>	<b>181 (112)</b>	<b>351 (184)</b>
2008	85 (16)	57 (22)	70 (8)	76 (18)	63 (28)	88 (52)	43 (18)	97 (45)	<b>261 (70)</b>	<b>318 (137)</b>	<b>579 (207)</b>
2009	56 (23)	30 (16)	52 (15)	38 (22)	29 (17)	66 (62)	33 (29)	54 (49)	<b>170 (84)</b>	<b>188 (149)</b>	<b>358 (233)</b>
2010	52 (31)	62 (56)	31 (31)	61 (56)	36 (30)	59 (56)	32 (32)	58 (58)	<b>151 (124)</b>	<b>240 (226)</b>	<b>391 (350)</b>
2011	36 (34)	54 (54)	34 (34)	57 (56)	37 (32)	66 (59)	33 (33)	57 (57)	<b>140 (133)</b>	<b>234 (226)</b>	<b>374 (359)</b>
2012	34 (31)	56 (56)	38 (35)	71 (54)	32 (31)	61 (60)	28 (28)	65 (62)	<b>132 (125)</b>	<b>253 (232)</b>	<b>385 (357)</b>
2013	30 (29)	79 (60)	41 (41)	49 (49)	31 (29)	61 (60)	34 (33)	54 (54)	<b>136 (132)</b>	<b>243 (223)</b>	<b>379 (355)</b>
2014	29 (27)	75 (63)	38 (38)	52 (52)	28 (28)	62 (62)	30 (30)	60 (58)	<b>125 (123)</b>	<b>249 (235)</b>	<b>374 (358)</b>
2015	28 (28)	62 (62)	31 (31)	59 (57)	31 (31)	54 (54)	22 (22)	38 (38)	<b>112 (112)</b>	<b>213 (211)</b>	<b>325 (323)</b>
2016	36 (36)	54 (54)	29 (29)	61 (61)	33 (28)	66 (62)	30 (30)	56 (56)	<b>128 (123)</b>	<b>237 (233)</b>	<b>365 (356)</b>
2017	28 (28)	62 (62)	36 (36)	54 (54)	27 (26)	60 (60)	29 (29)	61 (61)	<b>120 (119)</b>	<b>237 (237)</b>	<b>357 (356)</b>
2018	30 (30)	60 (60)	39 (39)	51 (51)	29 (29)	61 (61)	28 (28)	59 (59)	<b>126 (126)</b>	<b>231 (231)</b>	<b>357 (357)</b>
2019	25 (25)	62 (62)	28 (27)	56 (56)	29 (29)	61 (61)	33 (33)	57 (57)	<b>115 (114)</b>	<b>236 (236)</b>	<b>351 (350)</b>
2020	31 (31)	59 (59)	33 (30)	58 (50)	29 (26)	61 (59)	29 (29)	61 (61)	<b>122 (116)</b>	<b>239 (229)</b>	<b>361 (345)</b>
2021	30 (30)	60 (60)	30 (30)	60 (60)	30 (30)	60 (60)	27 (21)	63 (59)	<b>117 (111)</b>	<b>243 (239)</b>	<b>360 (350)</b>
2022	20 (20)	36 (36)	35 (35)	50 (50)	31 (30)	45 (45)	26 (26)	55 (55)	<b>112 (111)</b>	<b>186 (186)</b>	<b>298 (297)</b>
<b>Total</b>	<b>599 (437)</b>	<b>906 (805)</b>	<b>617 (467)</b>	<b>900 (768)</b>	<b>529 (440)</b>	<b>981 (903)</b>	<b>492 (451)</b>	<b>941 (866)</b>	<b>2,237 (1,795)</b>	<b>3,728 (3,342)</b>	<b>5,965 (5,137)</b>

**Table 47. SCDNR contemporary longline survey standardized index of relative abundance. RSE = relative standard error; lower and upper refer to the lower and upper bounds of a 95% CI as estimated using estimated marginal means. CPUE refers to the index on the catch scale, in this case catch per 120 hooks; Relative abundance is the index and confidence intervals normalized to the mean index value over all years of the survey.**

Year	Collections	% Positive	Red Drum	CPUE Index					Relative Abundance		
				CPUE	SE	RSE	Lower	Upper	Index	Lower	Upper
2007	182	22.53%	112	2.21	0.627	0.284	1.26	3.85	1.08	0.62	1.89
2008	203	26.11%	132	2.57	0.713	0.278	1.49	4.43	1.26	0.73	2.17
2009	230	33.48%	311	5.00	1.352	0.271	2.94	8.49	2.45	1.44	4.17
2010	326	33.74%	392	1.27	0.210	0.165	0.92	1.76	0.62	0.45	0.86
2011	345	37.97%	388	1.11	0.190	0.172	0.79	1.55	0.54	0.39	0.76
2012	338	42.31%	616	2.20	0.383	0.174	1.56	3.09	1.08	0.77	1.52
2013	346	44.51%	604	1.89	0.330	0.174	1.35	2.66	0.93	0.66	1.31
2014	356	43.82%	570	1.80	0.329	0.183	1.26	2.57	0.88	0.62	1.26
2015	320	49.38%	825	1.93	0.356	0.184	1.35	2.77	0.95	0.66	1.36
2016	351	53.85%	989	2.42	0.436	0.180	1.70	3.44	1.19	0.83	1.69
2017	354	40.40%	515	1.53	0.291	0.191	1.05	2.22	0.75	0.52	1.09
2018	354	37.01%	639	2.23	0.430	0.193	1.52	3.25	1.09	0.75	1.60
2019	346	46.82%	639	2.27	0.419	0.185	1.58	3.26	1.11	0.77	1.60
2020	343	46.06%	694	1.75	0.321	0.183	1.23	2.51	0.86	0.60	1.23
2021	348	33.91%	433	1.30	0.245	0.189	0.90	1.88	0.64	0.44	0.93
2022	296	39.53%	422	1.11	0.220	0.199	0.75	1.63	0.54	0.37	0.80

**Table 48. Georgia Coastal Longline Survey sampling methodologies. November 2006 – December 2020.**

<b>Sampling Design</b>	
Nov 2006 – Dec 2006:	Pilot Season
Nov 2006 – Present:	Random stratified based on Region (SGA and NFL) and Zone (Estuary, 0-3nm, 3-12nm). Grids ½ x ½ nm. Sep - Dec station allocation shifts from inshore to offshore.
2007 –2011:	Adaptive approach employed for Red Drum Sampling
2018 –2022:	Region NFL dropped
<b>Sampling Period</b>	
2006 – 2017:	Monthly Sampling by Zone. 25 stations
2018 – 2022:	Quarterly Sampling by Zone. 6-week time frame. 35 stations.
<b>Bait Type</b>	
2006:	100% mackerel
2007:	50% of hooks mackerel, 50% squid
2008 – 2015:	100% squid
2016 – 2020:	50% of hooks mullet, 50% squid
2021 – 2022:	100% of hooks mullet
<b>Hook Size</b>	
2006 – 2007:	15/0
2008 – 2015:	50% of hooks 15/0, 50% 12/0
2016 – 2022:	15/0

**Table 49. Model structure of the 25 candidate models used to estimate apparent survival (Phi), and encounter probability (p) for red drum tagged and released during fisheries-independent sampling by the South Carolina Department of Natural Resources from 1990-2022. The column 'MODEL' indicates the candidate model structure, including variables of age, time, sampling period, and constant probabilities (~1) as potential explanatory factors. NPAR indicates the number of parameters estimated in the corresponding model structure, and DELTA\_AIC is the difference between that model's Akaike's information criterion value (AIC) and the lowest AIC value of all the candidate models.**

MODEL	NPAR	DELTA_AIC
Phi(~age * time)p(~age * period)	105	0
Phi(~age + time)p(~age)	37	1
Phi(~age * time)p(~age)	99	2
Phi(~age + time)p(~period + age)	39	2
Phi(~time)p(~age)	35	2
Phi(~age * time)p(~period + age)	101	2
Phi(~time)p(~period + age)	37	3
Phi(~time)p(~age * period)	41	8
Phi(~age * time)p(~1)	97	9
Phi(~age * time)p(~period)	99	9
Phi(~age + time)p(~1)	35	12
Phi(~age + time)p(~period)	37	13
Phi(~age + time)p(~age * period)	43	15
Phi(~1)p(~period + age)	6	37
Phi(~age)p(~period + age)	8	38
Phi(~1)p(~age * period)	10	41
Phi(~time)p(~1)	33	42
Phi(~age)p(~age * period)	12	42
Phi(~time)p(~period)	35	43
Phi(~age)p(~period)	6	49
Phi(~1)p(~age)	4	66
Phi(~age)p(~age)	6	66
Phi(~age)p(~1)	4	76
Phi(~1)p(~period)	4	76
Phi(~1)p(~1)	2	99

**Table 50. Length-length relationships estimated for red drum.**

Stock	Dep. Variable	Unit	Ind. Variable	Unit	n	a	SE	b	SE	r2	Dependent Range	Independent Range
Northern	Total Length	mm	Standard Length	mm	1,190	6.057	1.008	1.183	2.445E-03	0.995	227 - 1,258	190 - 1,067
Northern	Total Length	mm	Fork Length	mm	19,466	-23.907	0.185	1.089	3.281E-04	0.998	150 - 1,441	149 - 1,346
Northern	Fork Length	mm	Standard Length	mm	199	39.730	2.660	1.076	4.978E-03	0.996	285 - 1,168	240 - 1,041
Northern	Fork Length	mm	Total Length	mm	19,466	22.861	0.164	0.917	2.764E-04	0.998	190 - 1,067	227 - 1,258
Northern	Standard Length	mm	Fork Length	mm	199	-34.625	2.624	0.925	4.279E-03	0.996	149 - 1,346	150 - 1,441
Northern	Standard Length	mm	Total Length	mm	1,189	-3.140	0.858	0.841	1.738E-03	0.995	190 - 1,067	227 - 1,258
Southern	Total Length	mm	Standard Length	mm	52,909	8.095	0.091	1.200	2.240E-04	0.998	5 - 1,183	4 - 1,005
Southern	Total Length	mm	Fork Length	mm	20,366	-20.339	0.276	1.091	3.589E-04	0.998	19 - 1,246	19 - 1,154
Southern	Fork Length	mm	Standard Length	mm	8,184	30.551	0.363	1.087	7.232E-04	0.996	19 - 1,135	15 - 1,005
Southern	Fork Length	mm	Total Length	mm	20,366	20.206	0.247	0.914	3.007E-04	0.998	19 - 1,154	19 - 1,246
Southern	Standard Length	mm	Fork Length	mm	8,184	-26.355	0.350	0.917	6.098E-04	0.996	15 - 1,005	19 - 1,135
Southern	Standard Length	mm	Total Length	mm	52,909	-6.046	0.077	0.832	1.552E-04	0.998	4 - 1,005	5 - 1,183



**Table 51. Life history parameters used in SS models for red drum.**

Parameter	Stock		Source
	Northern	Southern	
Age-2 Natural Mortality	0.158	0.233	Section 2.5
Amin (age for first size-at-age, Lmin)	one month old	five months old	Section 2.3
Lmin (TL cm)	6	Estimated	NA
Linf (TL cm)	Estimated	Estimated	NA
Maximum age	62	41	Section 2.3
von Bertalanffy Base <i>K</i> (youngest ages)	Estimated	Estimated	NA
<i>K</i> age break points	2, 6	1, 6	Section 2.3
Age break point <i>K</i> multipliers	Estimated	Estimated	NA
Length-at-age CV for smallest sizes	Estimated	Estimated	NA
Length-at-age CV for largest sizes	Estimated	Estimated	NA
Length-weight relationship alpha (TL cm-kg)	1.12E-05	1.13E-05	Current Assessment
Length-weight relationship beta (TL cm-kg)	2.9861	2.9827	Current Assessment
Female 50% maturity (age)	3.5	4.2	Section 2.4
Female maturity slope	-4.28	-1.55	Section 2.4
R0 (thousands of fish)	Estimated	Estimated	NA
sigma R	0.70	0.37	r4ss
steepness	0.99	0.99	ASMFC 2022

**Table 52. Fishing mortality reference points and status measures for red drum analyses including the Stock Synthesis integrated model (SS), traffic light analysis (TLA), and Skate index-based method.**

Measure	Description	Type	Analysis
$SPR_{30\%}$	Static spawning potential ratio resulting in 30% of unfished equilibrium spawning stock biomass	Threshold	SS
$F_{30\%}$	Age-2 fishing mortality associated with $SPR_{30\%}$	Threshold	SS
$SPR_{40\%}$	Static spawning potential ratio resulting in 40% of unfished equilibrium spawning stock biomass	Target	SS
$F_{40\%}$	Age-2 fishing mortality associated with $SPR_{40\%}$	Target	SS
$\overline{SPR}_{y-2,y-1,y}$	Three-year running average static spawning potential ratio in year <i>y</i>	Population Measure	SS
$SPR\ Status_y$	Three-year running average SPR in year <i>y</i> relative to SPR threshold: $\overline{SPR}_{y-2,y-1,y} > SPR_{30\%} =$ Not Overfishing $\overline{SPR}_{y-2,y-1,y} \leq SPR_{30\%} =$ Overfishing	Fishing Mortality Status	SS
Catch/Index	Ratio of the three year moving average of total catch divided by the three year moving average of an independent index.	Fishery Performance	Skate
Relative <i>F</i>	Median recommended fishing mortality based on the Catch/Index ratio.	Fishery Performance	Skate
%Reduction	Recommended reduction in fishing mortality when a stock is deemed to experience overfishing based on the Relative <i>F</i>		Skate

**Table 53. Biomass and abundance reference points and status measures for red drum analyses including the Stock Synthesis integrated model (SS) and traffic light analysis (TLA). Spawning stock biomass measures are in metric tons.**

Measure	Description	Type	Analysis
$SSB_{30\%}$	30% of unfished equilibrium spawning stock biomass	Threshold	SS
$SSB_{40\%}$	40% of unfished equilibrium spawning stock biomass	Target	SS
$\overline{SSB}_{y-2,y-1,y}$	Three-year running average spawning stock biomass in year $y$	Population Measure	SS
$SSB\ Status_y$	Three-year running average SSB in year $y$ relative to SSB threshold: $\overline{SSB}_{y-2,y-1,y} > SSB_{30\%}$ = Not Overfished $\overline{SSB}_{y-2,y-1,y} \leq SSB_{30\%}$ = Overfished	Biomass Status	SS

**Table 54. Configuration details for fishing fleets in the SS northern stock model.**

<u>Fishing Fleet Name</u>	<u>Years</u>	<u>Discard Mortality</u>	<u>Catch Error Type</u>	<u>Selectivity</u>	<u>Retention Periods</u>	<u>Composition Error Type</u>
North_Commercial_GNBS	1981-2022	1	Lognormal	Double Normal Length and Derived Age	1981-1991, 1992-1997, 1998-2022	Multinomial
North_Commercial_Other	1981-2022	n/a	Lognormal	Double Normal Length and Derived Age	1981-2022*	Multinomial
North_Recreational	1981-2022	0.08	Lognormal	Double Normal Length and Derived Age	1981-1991, 1992-1997, 1998-2022	Multinomial

\*The commercial other fleet is a selectivity block, not a retention block, due to a lack of discard information.

**Table 55. Configuration details for monitoring surveys in the SS northern stock model.**

<u>Survey Name</u>	<u>Years</u>	<u>Timing</u>	<u>Catch Error Type</u>	<u>Selectivity</u>	<u>Composition Error Type</u>
NC_BagSeine	1991-1995, 1997-2022	October 1	Lognormal	Age-0 Recruitment (SS special survey type 33)	NA
NC_GillNet	2003-2019, 2021-2022	October 1	Lognormal	Double Normal Length and Derived Age	Multinomial
NC_Longline	2007-2019, 2021-2022	September 1	Lognormal	Logistic Age	Multinomial

**Table 56. Retention block details for fishing fleets in the SS northern stock model.**

<u>Fleet</u>	<u>Years</u>	<u>Parameters</u>	<u>Regulation Change</u>
North_Commercial_GNBS	1992-1997	Inflection, Width, Asymptote, Dome Inflection, Dome Width	Minimum size increase, Maximum size decrease
North_Commercial_GNBS	1998-2022	Asymptote, Dome Inflection, Dome Width	Maximum size decrease, Commercial trip limit implemented
North_Recreational	1992-1997	Inflection, Width, Asymptote, Dome Inflection, Dome Width	Minimum size increase, Maximum size decrease
North_Recreational	1998-2022	Inflection, Width, Asymptote, Dome Inflection, Dome Width	Maximum size decrease, Bag limit decrease

**Table 57. Configuration details for fishing fleets in the SS southern stock model.**

<u>Fishing Fleet Name</u>	<u>Years</u>	<u>Discard Mortality</u>	<u>Catch Error Type</u>	<u>Selectivity</u>	<u>Retention Periods</u>	<u>Composition Error Type</u>
SC_Recreational	1981-2022	0.08	Lognormal	Double Normal Length and Derived Age	1981-1989, 1990-1992, 1993-2000, 2001-2006, 2007-2017, 2018--2022	Multinomial
GA_Recreational	1981-2022	0.08	Lognormal	Double Normal Length and Derived Age	1981-1985, 1986-1992, 1993-2001, 2002-2022	Multinomial
FL_Recreational	1981-2022	0.08	Lognormal	Double Normal Length and Derived Age	1981-1984, 1985-1988, 1989-2022	Multinomial

**Table 58. Configuration details for monitoring surveys in the SS southern stock model.**

<u>Survey Name</u>	<u>Years</u>	<u>Timing</u>	<u>Catch Error Type</u>	<u>Selectivity</u>	<u>Composition Error Type</u>
FL_21.3_HaulSeine	2001-2021	October 15	Lognormal	Age-0 Recruitment (SS special survey type 33)	NA
SC_Rotenone	1986-1993	October 15	Lognormal	Age-0 Recruitment (SS special survey type 33)	NA
GA_GillNet	2002-2022	July 15	Lognormal	Age-0 Only	NA
SC_StopNet	1987-1993	July 1	Lognormal	Double Normal Age	Multinomial
SC_Trammel	1991-2022	July 1	Lognormal	Double Normal Age	Multinomial
FL_183_HaulSeine	2001-2021	July 1	Lognormal	Double Normal Age	Multinomial
SC_Longline_contemporary	2007-2022	October 15	Lognormal	Double Normal Length and Derived Age	Multinomial

**Table 59. Retention block details for fishing fleets in the SS southern stock model.**

<u>Fleet</u>	<u>Years</u>	<u>Parameters</u>	<u>Regulation Change</u>
SC_Recreational	1990-1992	Inflection, Width, Asymptote	Minimum size season to full year
SC_Recreational	1993-2000	Dome Inflection, Dome Width	Maximum size
SC_Recreational	2001-2006	Inflection, Width, Asymptote, Dome Inflection, Dome Width	Minimum size increase, Maximum size decrease, Bag limit decrease
SC_Recreational	2007-2017	Asymptote	Bag limit increase
SC_Recreational	2018-2022	Asymptote	Bag limit decrease, Vessel limit
GA_Recreational	1986-1992	Inflection, Width, Dome Inflection, Dome Width	Minimum size, Bag limit for fish >32"
GA_Recreational	1993-2001	Dome Inflection, Dome Width	Maximum size
GA_Recreational	2002-2022	Dome Inflection, Dome Width	Maximum size decrease
FL_Recreational	1985-1988	Inflection, Width	Minimum size increase
FL_Recreational	1989-2022	Asymptote, Dome Inflection, Dome Width	Maximum size, Bag limit

**Table 60. Life history and recruitment parameters for the northern stock SS estimated selectivity model.**

Parameter	Type	Final Value	SE	Lower Bound	Upper Bound	Prior Type	Prior Mean	Prior sd
NatM_Lorenzo_Fem_GP_1	Fixed	0.1580	NA	NA	NA	NA	NA	NA
L_at_Amin_Fem_GP_1	Fixed	6.0000	NA	NA	NA	NA	NA	NA
L_at_Amax_Fem_GP_1	Estimated	131.9730	1.0654	100	150	Sym Beta	NA	0.158
VonBert_K_young_Fem_GP_1	Estimated	0.2860	0.0031	0.1	0.9	NA	NA	NA
Age_K_mult_Fem_GP_1_a_2	Estimated	0.9584	0.0184	0.1	1.5	NA	NA	NA
Age_K_mult_Fem_GP_1_a_6	Estimated	0.1550	0.0115	0.01	1	NA	NA	NA
CV_young_Fem_GP_1	Estimated	0.2989	0.0025	0.01	0.4	NA	NA	NA
CV_old_Fem_GP_1	Estimated	0.0321	0.0024	0.01	0.2	NA	NA	NA
Wtlen_1_Fem_GP_1	Fixed	0.0000	NA	NA	NA	NA	NA	NA
Wtlen_2_Fem_GP_1	Fixed	2.9861	NA	NA	NA	NA	NA	NA
Mat50%_Fem_GP_1	Fixed	3.5000	NA	NA	NA	NA	NA	NA
Mat_slope_Fem_GP_1	Fixed	-4.2800	NA	NA	NA	NA	NA	NA
SR_LN(R0)	Estimated	7.9141	0.0792	3	11	Sym Beta	NA	0.5
SR_BH_steep	Fixed	0.9900	NA	NA	NA	NA	NA	NA
SR_sigmaR	Fixed	0.6953	NA	NA	NA	NA	NA	NA
Early_InitAge_11	Deviation	1.4753	0.2558	-5	5	NA	NA	NA
Early_InitAge_10	Deviation	2.2592	0.1725	-5	5	NA	NA	NA
Early_InitAge_9	Deviation	2.4621	0.1490	-5	5	NA	NA	NA
Early_InitAge_8	Deviation	3.5557	0.0983	-5	5	NA	NA	NA
Early_InitAge_7	Deviation	2.4917	0.1305	-5	5	NA	NA	NA
Early_InitAge_6	Deviation	1.0123	0.2183	-5	5	NA	NA	NA
Early_InitAge_5	Deviation	-0.2788	0.3407	-5	5	NA	NA	NA
Early_InitAge_4	Deviation	-0.3560	0.3295	-5	5	NA	NA	NA
Early_InitAge_3	Deviation	2.2446	0.1141	-5	5	NA	NA	NA
Early_InitAge_2	Deviation	0.8456	0.1773	-5	5	NA	NA	NA
Early_InitAge_1	Deviation	1.0973	0.1470	-5	5	NA	NA	NA
Main_RecrDev_1981	Deviation	0.3510	0.1817	-5	5	NA	NA	NA
Main_RecrDev_1982	Deviation	0.6231	0.1502	-5	5	NA	NA	NA
Main_RecrDev_1983	Deviation	0.2586	0.1515	-5	5	NA	NA	NA
Main_RecrDev_1984	Deviation	-0.4190	0.1843	-5	5	NA	NA	NA
Main_RecrDev_1985	Deviation	0.6424	0.1016	-5	5	NA	NA	NA
Main_RecrDev_1986	Deviation	0.2376	0.1074	-5	5	NA	NA	NA
Main_RecrDev_1987	Deviation	0.4486	0.0874	-5	5	NA	NA	NA
Main_RecrDev_1988	Deviation	-0.7714	0.1266	-5	5	NA	NA	NA
Main_RecrDev_1989	Deviation	-0.2009	0.1107	-5	5	NA	NA	NA
Main_RecrDev_1990	Deviation	0.6357	0.0904	-5	5	NA	NA	NA
Main_RecrDev_1991	Deviation	0.4382	0.0869	-5	5	NA	NA	NA
Main_RecrDev_1992	Deviation	-0.0965	0.0942	-5	5	NA	NA	NA
Main_RecrDev_1993	Deviation	0.4952	0.0833	-5	5	NA	NA	NA
Main_RecrDev_1994	Deviation	-0.1661	0.0910	-5	5	NA	NA	NA
Main_RecrDev_1995	Deviation	-0.3266	0.0989	-5	5	NA	NA	NA
Main_RecrDev_1996	Deviation	0.8758	0.0815	-5	5	NA	NA	NA
Main_RecrDev_1997	Deviation	0.6002	0.0727	-5	5	NA	NA	NA
Main_RecrDev_1998	Deviation	0.1446	0.0711	-5	5	NA	NA	NA
Main_RecrDev_1999	Deviation	-1.0254	0.0829	-5	5	NA	NA	NA
Main_RecrDev_2000	Deviation	-0.7491	0.0693	-5	5	NA	NA	NA
Main_RecrDev_2001	Deviation	-0.1437	0.0524	-5	5	NA	NA	NA
Main_RecrDev_2002	Deviation	-0.6962	0.0605	-5	5	NA	NA	NA
Main_RecrDev_2003	Deviation	0.1527	0.0530	-5	5	NA	NA	NA
Main_RecrDev_2004	Deviation	0.0930	0.0517	-5	5	NA	NA	NA
Main_RecrDev_2005	Deviation	0.7606	0.0445	-5	5	NA	NA	NA
Main_RecrDev_2006	Deviation	-0.2239	0.0549	-5	5	NA	NA	NA
Main_RecrDev_2007	Deviation	0.6598	0.0449	-5	5	NA	NA	NA
Main_RecrDev_2008	Deviation	-0.3695	0.0583	-5	5	NA	NA	NA
Main_RecrDev_2009	Deviation	-0.6321	0.0582	-5	5	NA	NA	NA
Main_RecrDev_2010	Deviation	-1.0812	0.0681	-5	5	NA	NA	NA
Main_RecrDev_2011	Deviation	1.6562	0.0448	-5	5	NA	NA	NA
Main_RecrDev_2012	Deviation	-0.1859	0.0639	-5	5	NA	NA	NA
Main_RecrDev_2013	Deviation	-0.5870	0.0599	-5	5	NA	NA	NA
Main_RecrDev_2014	Deviation	-0.6316	0.0644	-5	5	NA	NA	NA
Main_RecrDev_2015	Deviation	0.8131	0.0517	-5	5	NA	NA	NA
Main_RecrDev_2016	Deviation	-0.4527	0.0629	-5	5	NA	NA	NA
Main_RecrDev_2017	Deviation	-0.9489	0.0761	-5	5	NA	NA	NA
Main_RecrDev_2018	Deviation	1.2281	0.0572	-5	5	NA	NA	NA
Main_RecrDev_2019	Deviation	0.9256	0.0601	-5	5	NA	NA	NA
Main_RecrDev_2020	Deviation	-0.5437	0.0736	-5	5	NA	NA	NA
Main_RecrDev_2021	Deviation	-0.9532	0.0865	-5	5	NA	NA	NA
Main_RecrDev_2022	Deviation	-0.8356	0.2117	-5	5	NA	NA	NA
ForeRecr_2023	Deviation	0.0000	0.6953	-5	5	NA	NA	NA

**Table 61. Fishing fleet initial fishing mortality, selectivity, retention, and discard mortality parameters for the northern stock SS estimated selectivity model.**

Parameter	Type	Final Value	SE	Lower Bound	Upper Bound	Prior Type	Prior Mean	Prior sd
InitF_seas_1_flt_1North_Commercial_GNBS	Estimated	0.0039	0.0046	0	0.8	Sym Beta	NA	0.75
InitF_seas_1_flt_2North_Commercial_Other	Estimated	0.0000	0.0000	0	1	NA	NA	NA
InitF_seas_1_flt_3North_Recreational	Estimated	0.0081	0.0095	0	1	Sym Beta	NA	0.75
Size_DblN_peak_North_Commercial_GNBS(1)	Estimated	36.2269	0.3015	15	60	NA	NA	NA
Size_DblN_top_logit_North_Commercial_GNBS(1)	Estimated	-1.2640	0.0188	-6	2	NA	NA	NA
Size_DblN_ascend_se_North_Commercial_GNBS(1)	Estimated	3.4909	0.0680	0.01	8	NA	NA	NA
Size_DblN_descend_se_North_Commercial_GNBS(1)	Estimated	3.4728	0.0847	2	8	NA	NA	NA
Size_DblN_start_logit_North_Commercial_GNBS(1)	Fixed	-999.0000	NA	NA	NA	NA	NA	NA
Size_DblN_end_logit_North_Commercial_GNBS(1)	Estimated	-9.2334	0.4609	-15	-1	NA	NA	NA
Retain_L_infl_North_Commercial_GNBS(1)	Estimated	32.2250	1.5850	20	60	NA	NA	NA
Retain_L_width_North_Commercial_GNBS(1)	Estimated	0.3181	0.7495	0.01	5	NA	NA	NA
Retain_L_asymptote_logit_North_Commercial_GNBS(1)	Estimated	1.3318	0.1522	-5	8	NA	NA	NA
Retain_L_dome_infl_North_Commercial_GNBS(1)	Estimated	89.9933	0.2166	60	90	NA	NA	NA
Retain_L_dome_width_North_Commercial_GNBS(1)	Estimated	4.9989	0.0380	0.01	5	NA	NA	NA
DiscMort_L_level_old_North_Commercial_GNBS(1)	Fixed	1.0000	NA	NA	NA	NA	NA	NA
Size_DblN_peak_North_Commercial_Other(2)	Estimated	62.3001	0.7034	30	65	NA	NA	NA
Size_DblN_top_logit_North_Commercial_Other(2)	Estimated	-12.5151	45.1034	-15	0	NA	NA	NA
Size_DblN_ascend_se_North_Commercial_Other(2)	Estimated	5.4824	0.0918	0.01	8	NA	NA	NA
Size_DblN_descend_se_North_Commercial_Other(2)	Estimated	3.8250	0.2015	2	6	NA	NA	NA
Size_DblN_start_logit_North_Commercial_Other(2)	Fixed	-11.9000	NA	NA	NA	NA	NA	NA
Size_DblN_end_logit_North_Commercial_Other(2)	Estimated	-7.3870	0.4473	-15	-2	NA	NA	NA
Size_DblN_peak_North_Recreational(3)	Estimated	32.8010	0.2163	20	100	NA	NA	NA
Size_DblN_top_logit_North_Recreational(3)	Estimated	-5.0000	0.0000	-5	4	NA	NA	NA
Size_DblN_ascend_se_North_Recreational(3)	Estimated	3.3809	0.0697	0.01	10	NA	NA	NA
Size_DblN_descend_se_North_Recreational(3)	Estimated	6.2505	0.0227	0.01	8	NA	NA	NA
Size_DblN_start_logit_North_Recreational(3)	Estimated	-5.1164	0.2109	-15	8	NA	NA	NA
Size_DblN_end_logit_North_Recreational(3)	Estimated	-4.5648	0.0643	-15	5	NA	NA	NA
Retain_L_infl_North_Recreational(3)	Estimated	30.2293	1.0168	15	60	NA	NA	NA
Retain_L_width_North_Recreational(3)	Estimated	3.1397	0.6104	0.01	8	NA	NA	NA
Retain_L_asymptote_logit_North_Recreational(3)	Estimated	12.4510	110.6340	-1	20	NA	NA	NA
Retain_L_dome_infl_North_Recreational(3)	Estimated	72.9680	4.0785	60	100	NA	NA	NA
Retain_L_dome_width_North_Recreational(3)	Estimated	14.9843	0.4831	0.01	15	NA	NA	NA
DiscMort_L_level_old_North_Recreational(3)	Fixed	0.0800	NA	NA	NA	NA	NA	NA
Retain_L_infl_North_Commercial_GNBS(1)_BLK2repl_1992	Estimated	44.4620	0.1376	30	60	NA	NA	NA
Retain_L_width_North_Commercial_GNBS(1)_BLK2repl_1992	Estimated	0.8326	0.0588	0.01	3	NA	NA	NA
Retain_L_asymptote_logit_North_Commercial_GNBS(1)_BLK1repl_1992	Estimated	4.9853	0.4631	0	5	NA	NA	NA
Retain_L_asymptote_logit_North_Commercial_GNBS(1)_BLK1repl_1998	Estimated	2.0181	0.0566	0	5	NA	NA	NA
Retain_L_dome_infl_North_Commercial_GNBS(1)_BLK1repl_1992	Estimated	89.9808	0.6113	60	90	NA	NA	NA
Retain_L_dome_infl_North_Commercial_GNBS(1)_BLK1repl_1998	Estimated	75.4998	1.1353	60	90	NA	NA	NA
Retain_L_dome_width_North_Commercial_GNBS(1)_BLK1repl_1992	Estimated	4.9887	0.3592	0.01	5	NA	NA	NA
Retain_L_dome_width_North_Commercial_GNBS(1)_BLK1repl_1998	Estimated	2.4837	0.5109	0.01	5	NA	NA	NA
Retain_L_infl_North_Recreational(3)_BLK1repl_1992	Estimated	53.0134	0.7903	30	60	NA	NA	NA
Retain_L_infl_North_Recreational(3)_BLK1repl_1998	Estimated	49.2112	0.4074	30	60	NA	NA	NA
Retain_L_width_North_Recreational(3)_BLK1repl_1992	Estimated	6.0000	0.0047	0.01	6	NA	NA	NA
Retain_L_width_North_Recreational(3)_BLK1repl_1998	Estimated	3.2593	0.1567	0.01	6	NA	NA	NA
Retain_L_asymptote_logit_North_Recreational(3)_BLK1repl_1992	Estimated	1.9916	0.2659	-1	2	NA	NA	NA
Retain_L_asymptote_logit_North_Recreational(3)_BLK1repl_1998	Estimated	0.1640	0.1011	-1	2	NA	NA	NA
Retain_L_dome_infl_North_Recreational(3)_BLK1repl_1992	Estimated	85.7027	3.7643	60	90	NA	NA	NA
Retain_L_dome_infl_North_Recreational(3)_BLK1repl_1998	Estimated	71.7439	0.7245	60	90	NA	NA	NA
Retain_L_dome_width_North_Recreational(3)_BLK1repl_1992	Estimated	9.1637	1.5071	0.01	10	NA	NA	NA
Retain_L_dome_width_North_Recreational(3)_BLK1repl_1998	Estimated	4.2413	0.5477	0.01	10	NA	NA	NA

**Table 62. Survey catchability coefficient and selectivity parameters for the northern stock SS estimated selectivity model.**

Parameter	Type	Final Value	SE	Lower Bound	Upper Bound
LnQ_base_NC_BagSeine(4)	Derived	-7.8853	NA	NA	NA
LnQ_base_NC_GillNet(5)	Derived	-7.3057	NA	NA	NA
LnQ_base_NC_Longline(6)	Derived	-8.6809	NA	NA	NA
Size_DblN_peak_NC_GillNet(5)	Estimated	39.4060	0.2827	20	50
Size_DblN_top_logit_NC_GillNet(5)	Estimated	-9.9446	1.7092	-10	-1
Size_DblN_ascend_se_NC_GillNet(5)	Estimated	4.4289	0.0595	1	8
Size_DblN_descend_se_NC_GillNet(5)	Estimated	5.8338	0.0263	4	8
Size_DblN_start_logit_NC_GillNet(5)	Estimated	-8.2439	0.5586	-25	-5
Size_DblN_end_logit_NC_GillNet(5)	Estimated	-5.9727	0.0793	-8	-2
Age_inflection_NC_Longline(6)	Estimated	19.5342	1.1525	3	62
Age_95%width_NC_Longline(6)	Estimated	12.3119	0.8933	5	40

**Table 63. Jitter analysis results for the northern stock SS estimated selectivity model. The -LL column shows the change in total negative log-likelihood relative to the base model.**

<b>-LL</b>	<b>Δ -LL</b>	<b>Frequency</b>	<b>Converged?</b>
18,607.0	-0.3	6	Yes
18,607.3	0.0	19	Yes
18,698.8	91.5	1	No
18,762.3	155.0	1	No
18,786.7	179.4	1	No
18,788.0	180.7	1	No
18,870.8	263.5	1	No
19,026.0	418.7	1	No
19,058.7	451.4	1	No
19,275.7	668.4	1	No
19,400.4	793.1	1	No
19,697.3	1,090.0	1	No
19,753.1	1,145.8	1	No
20,680.8	2,073.5	1	No
20,701.9	2,094.6	1	No
20,747.1	2,139.8	1	No
20,966.5	2,359.2	1	No
21,319.9	2,712.6	1	No
21,494.9	2,887.6	1	No
21,654.2	3,046.9	1	No
21,900.7	3,293.4	1	No
21,949.7	3,342.4	1	No
21,970.5	3,363.2	1	No
22,342.7	3,735.4	1	No
27,696.3	9,089.0	1	No
33,542.7	14,935.4	1	No
57,944.2	39,336.9	1	No



**Table 64. Beginning of fishing year abundance estimates (in 1000s of fish) for the northern stock SS estimated selectivity model.**

Year	0	1	2	3	4	5	6	7	8	9	10	11	12	13	14	15	16	17	18	19	20+	Total
1981	3,069	3,948	2,440	8,412	552	535	1,764	7,046	18,593	5,677	4,227	1,762	438	398	361	328	299	272	247	225	2,393	62,989
1982	4,029	1,874	3,113	2,072	7,378	492	482	1,593	6,371	16,827	5,142	3,832	1,598	398	361	328	299	272	247	225	2,393	59,327
1983	2,798	2,457	1,451	2,628	1,815	6,575	443	435	1,441	5,766	15,240	4,660	3,476	1,451	361	328	299	272	247	225	2,393	54,762
1984	1,421	1,704	1,842	1,203	2,294	1,617	5,916	400	393	1,304	5,222	13,813	4,227	3,154	1,317	328	299	272	247	225	2,393	49,592
1985	4,107	854	1,083	1,465	1,042	2,040	1,454	5,341	361	356	1,180	4,730	12,522	3,835	2,863	1,197	298	272	247	225	2,392	47,864
1986	2,740	2,493	610	885	1,275	928	1,835	1,313	4,829	327	322	1,069	4,290	11,363	3,482	2,602	1,088	271	247	225	2,391	44,586
1987	3,383	1,654	1,674	492	769	1,134	835	1,657	1,187	4,368	296	292	970	3,892	10,317	3,163	2,365	989	247	225	2,391	42,298
1988	999	2,045	1,130	1,354	428	684	1,020	754	1,498	1,074	3,955	268	265	880	3,534	9,372	2,875	2,151	900	225	2,390	37,800
1989	1,767	598	1,225	881	1,169	380	615	921	681	1,355	972	3,582	243	240	799	3,209	8,517	2,614	1,957	819	2,388	34,931
1990	4,079	1,053	338	935	757	1,038	342	555	832	616	1,226	880	3,246	220	218	725	2,916	7,743	2,378	1,781	2,928	34,805
1991	3,347	2,476	747	275	813	674	934	308	502	753	557	1,111	798	2,946	200	198	659	2,652	7,047	2,165	4,297	33,460
1992	1,961	2,035	1,819	619	240	724	607	844	279	454	682	505	1,007	724	2,675	182	180	600	2,414	6,417	5,896	30,863
1993	3,544	1,196	1,549	1,508	540	214	651	548	763	252	411	618	458	914	658	2,431	165	164	546	2,198	11,226	30,553
1994	1,829	2,156	861	1,243	1,304	480	192	588	495	690	228	372	560	416	830	598	2,209	150	149	497	12,239	28,086
1995	1,558	1,116	1,648	715	1,084	1,161	432	173	531	448	625	207	338	508	377	754	543	2,010	137	136	11,618	26,118
1996	5,184	947	788	1,307	617	963	1,043	390	157	481	405	566	188	306	461	343	685	494	1,828	125	10,722	28,000
1997	3,935	3,160	711	648	1,137	549	866	942	352	142	435	367	513	170	278	419	312	623	449	1,665	9,900	27,573
1998	2,495	2,399	2,378	585	564	1,012	494	782	852	319	128	394	333	466	155	253	381	283	567	409	10,557	25,806
1999	774	1,518	1,733	1,922	508	502	910	446	707	770	288	116	358	302	423	140	230	347	258	516	10,011	22,780
2000	1,021	469	1,015	1,344	1,657	452	452	822	403	639	697	261	105	324	274	384	128	209	315	235	9,610	20,817
2001	1,870	618	307	779	1,156	1,473	406	408	743	364	579	632	237	96	294	249	349	116	190	287	8,987	20,138
2002	1,076	1,132	406	236	670	1,028	1,324	367	368	671	330	524	572	215	87	267	226	317	106	173	8,467	18,563
2003	2,514	646	635	288	200	594	923	1,194	331	333	607	298	474	519	195	79	243	206	288	96	7,884	18,548
2004	2,368	1,524	438	497	249	178	535	833	1,079	300	301	550	270	430	471	177	72	221	187	262	7,291	18,232
2005	4,617	1,443	1,138	360	433	221	160	483	753	976	271	273	499	245	391	428	161	65	201	170	6,904	20,193
2006	1,725	2,802	996	898	311	385	199	145	436	681	884	246	247	452	223	355	389	146	59	183	6,466	18,228
2007	4,173	1,048	1,980	796	778	277	347	180	131	395	617	801	223	224	411	202	323	353	133	54	6,078	19,523
2008	1,491	2,524	677	1,510	683	692	249	313	162	118	357	559	726	202	204	373	184	293	321	121	5,605	17,364
2009	1,147	905	1,742	534	1,305	608	622	225	283	147	107	324	506	658	183	185	339	167	267	293	5,236	15,782
2010	732	690	534	1,267	455	1,159	546	561	203	255	133	97	293	459	597	166	168	308	152	243	5,052	14,071
2011	11,302	440	403	386	1,078	404	1,041	493	507	184	231	120	88	266	416	542	151	153	280	138	4,838	23,459
2012	1,791	6,670	179	242	317	951	362	937	444	457	166	209	109	79	240	377	491	137	138	254	4,539	19,089
2013	1,199	1,088	4,690	143	209	282	856	327	847	402	414	150	189	99	72	218	343	446	125	126	4,383	16,607
2014	1,146	717	578	3,234	120	186	253	771	295	765	363	374	136	171	89	65	198	311	406	113	4,119	14,412
2015	4,863	690	427	422	2,756	107	167	228	696	267	692	329	339	123	155	81	59	180	283	369	3,868	17,101
2016	1,371	2,934	427	318	361	2,448	96	150	206	630	241	626	298	307	112	141	74	54	164	257	3,873	15,088
2017	835	823	1,660	305	270	320	2,198	87	136	186	569	218	567	270	279	101	128	67	49	149	3,773	12,990
2018	7,361	498	407	1,102	255	239	288	1,981	78	123	168	515	197	514	244	253	92	116	61	44	3,580	18,115
2019	5,439	4,390	247	271	922	226	215	259	1,787	70	111	152	466	179	465	222	229	83	106	55	3,310	19,204
2020	1,251	3,294	2,935	192	233	820	203	194	234	1,616	64	100	138	422	162	423	201	208	76	96	3,078	15,941
2021	831	754	2,012	2,176	164	207	737	183	175	212	1,462	58	91	125	383	147	384	183	189	69	2,902	13,443
2022	935	496	385	1,360	1,827	145	186	664	165	158	191	1,322	52	82	113	347	134	348	166	172	2,714	11,963

**Table 65. Female spawning stock biomass estimates for the northern stock SS estimated selectivity model. 95% confidence intervals are based on asymptotic standard errors.**

Year	Annual SSB (metric tons)			Annual Relative SSB			Three-Year Average Relative SSB
	LCI	Estimate	UCI	LCI	Estimate	UCI	
Unfished	33,944	40,162	46,380	NA	NA	NA	NA
Target	13,544	16,004	18,463	NA	NA	NA	NA
Threshold	10,137	11,977	13,818	NA	1.000	NA	1.000
1981	122,167	163,424	204,681	11.699	13.564	15.429	NA
1982	122,986	164,490	205,994	11.795	13.652	15.510	NA
1983	120,730	161,474	202,218	11.587	13.402	15.217	13.539
1984	118,234	158,134	198,034	11.355	13.125	14.894	13.393
1985	112,734	150,791	188,848	10.834	12.515	14.197	13.014
1986	107,364	143,603	179,842	10.325	11.919	13.512	12.520
1987	101,395	135,629	169,863	9.757	11.257	12.756	11.897
1988	95,330	127,510	159,690	9.178	10.583	11.988	11.253
1989	90,160	120,598	151,036	8.687	10.009	11.332	10.616
1990	85,151	113,903	142,655	8.210	9.454	10.697	10.015
1991	80,596	107,793	134,990	7.777	8.947	10.117	9.470
1992	75,603	101,098	126,593	7.298	8.391	9.484	8.930
1993	71,139	95,093	119,047	6.871	7.892	8.914	8.410
1994	67,893	90,680	113,466	6.565	7.526	8.487	7.937
1995	65,148	86,892	108,637	6.307	7.212	8.117	7.543
1996	62,192	82,840	103,488	6.026	6.876	7.725	7.205
1997	59,749	79,433	99,116	5.796	6.593	7.390	6.893
1998	56,905	75,525	94,146	5.524	6.268	7.013	6.579
1999	54,180	71,787	89,393	5.263	5.958	6.653	6.273
2000	52,818	69,814	86,810	5.138	5.794	6.451	6.007
2001	51,492	67,915	84,338	5.015	5.637	6.258	5.796
2002	49,690	65,433	81,176	4.845	5.431	6.017	5.621
2003	46,915	61,744	76,573	4.577	5.125	5.672	5.397
2004	44,047	57,936	71,825	4.299	4.809	5.318	5.121
2005	41,504	54,551	67,597	4.054	4.528	5.001	4.820
2006	39,168	51,429	63,691	3.828	4.269	4.709	4.535
2007	37,626	49,290	60,954	3.680	4.091	4.502	4.296
2008	36,382	47,528	58,674	3.561	3.945	4.328	4.101
2009	36,087	46,939	57,791	3.535	3.896	4.256	3.977
2010	35,071	45,491	55,911	3.438	3.776	4.113	3.872
2011	34,574	44,700	54,826	3.392	3.710	4.028	3.794
2012	33,083	42,706	52,329	3.247	3.545	3.842	3.677
2013	31,433	40,518	49,603	3.086	3.363	3.640	3.539
2014	29,730	38,279	46,829	2.920	3.177	3.435	3.361
2015	31,276	40,058	48,840	3.074	3.325	3.575	3.288
2016	31,062	39,706	48,350	3.053	3.295	3.538	3.266
2017	30,241	38,611	46,982	2.971	3.205	3.438	3.275
2018	28,619	36,529	44,439	2.812	3.032	3.251	3.177
2019	27,869	35,534	43,200	2.739	2.949	3.160	3.062
2020	26,700	34,023	41,347	2.623	2.824	3.024	2.935
2021	25,566	32,545	39,524	2.511	2.701	2.891	2.825
2022	26,383	33,397	40,411	2.587	2.772	2.957	2.766

**Table 66. Age-2 fishing mortality (F) and spawning potential ratio (SPR) estimates for the northern stock SS estimated selectivity model. 95% confidence intervals are based on asymptotic standard errors.**

Year	Age-2 F			Annual SPR			Three-Year Average SPR
	LCI	Estimate	UCI	LCI	Estimate	UCI	
Target	0.267	0.274	0.281	NA	0.400	NA	0.400
Threshold	0.350	0.360	0.369	NA	0.300	NA	0.300
1981	0.010	0.015	0.019	0.969	0.976	0.984	NA
1982	0.021	0.031	0.041	0.935	0.950	0.966	NA
1983	0.040	0.057	0.074	0.868	0.898	0.928	0.941
1984	0.074	0.104	0.134	0.634	0.710	0.786	0.853
1985	0.096	0.134	0.173	0.791	0.837	0.883	0.815
1986	0.115	0.160	0.205	0.710	0.767	0.825	0.771
1987	0.105	0.144	0.183	0.734	0.786	0.837	0.797
1988	0.139	0.187	0.236	0.576	0.650	0.723	0.734
1989	0.175	0.238	0.302	0.507	0.595	0.683	0.677
1990	0.171	0.235	0.298	0.778	0.825	0.872	0.690
1991	0.130	0.179	0.228	0.845	0.877	0.909	0.766
1992	0.075	0.102	0.130	0.887	0.910	0.933	0.871
1993	0.084	0.113	0.142	0.779	0.820	0.861	0.869
1994	0.083	0.110	0.138	0.896	0.916	0.936	0.882
1995	0.115	0.151	0.186	0.745	0.791	0.836	0.842
1996	0.098	0.128	0.159	0.859	0.885	0.912	0.864
1997	0.105	0.137	0.168	0.866	0.891	0.917	0.856
1998	0.092	0.119	0.146	0.800	0.835	0.870	0.871
1999	0.135	0.173	0.212	0.680	0.731	0.782	0.819
2000	0.186	0.238	0.291	0.647	0.703	0.759	0.756
2001	0.224	0.284	0.345	0.654	0.708	0.761	0.714
2002	0.291	0.367	0.443	0.466	0.538	0.610	0.650
2003	0.276	0.349	0.423	0.698	0.748	0.797	0.665
2004	0.227	0.288	0.349	0.861	0.884	0.906	0.723
2005	0.151	0.189	0.228	0.731	0.771	0.810	0.801
2006	0.137	0.169	0.201	0.771	0.803	0.836	0.819
2007	0.196	0.239	0.283	0.640	0.688	0.735	0.754
2008	0.196	0.239	0.281	0.735	0.771	0.806	0.754
2009	0.269	0.326	0.383	0.531	0.588	0.644	0.682
2010	0.308	0.374	0.440	0.517	0.576	0.635	0.645
2011	0.561	0.629	0.697	0.285	0.306	0.328	0.490
2012	0.491	0.544	0.596	0.766	0.797	0.828	0.560
2013	0.529	0.588	0.648	0.426	0.488	0.550	0.530
2014	0.333	0.405	0.477	0.536	0.595	0.654	0.627
2015	0.383	0.467	0.550	0.583	0.637	0.692	0.573
2016	0.362	0.435	0.509	0.492	0.546	0.599	0.593
2017	0.436	0.525	0.614	0.364	0.430	0.497	0.538
2018	0.517	0.631	0.745	0.359	0.434	0.509	0.470
2019	0.451	0.551	0.652	0.690	0.729	0.769	0.531
2020	0.371	0.449	0.526	0.576	0.623	0.669	0.595
2021	0.364	0.434	0.504	0.396	0.456	0.517	0.603
2022	0.615	0.687	0.759	0.273	0.295	0.317	0.458

**Table 67. Life history and recruitment parameters for the southern stock SS base model.**

Parameter	Type	Final Value	SE	Lower Bound	Upper Bound
NatM_Lorenzen_Fem_GP_1	Fixed	0.233	NA	NA	NA
L_at_Amin_Fem_GP_1	Estimated	21.3248	0.170502	6	25
L_at_Amax_Fem_GP_1	Estimated	107.465	0.886232	90	130
VonBert_K_young_Fem_GP_1	Estimated	0.42621	0.009498	0.1	0.7
Age_K_mult_Fem_GP_1_a_1	Estimated	0.522782	0.007614	0.01	1
Age_K_mult_Fem_GP_1_a_6	Estimated	0.258823	0.017846	0.01	1
CV_young_Fem_GP_1	Estimated	0.186205	0.00228	0.05	0.4
CV_old_Fem_GP_1	Estimated	0.0213179	0.002133	0.01	0.3
Wtlen_1_Fem_GP_1	Fixed	0.0000136	NA	NA	NA
Wtlen_2_Fem_GP_1	Fixed	2.91963	NA	NA	NA
Mat50%_Fem_GP_1	Fixed	4.2	NA	NA	NA
Mat_slope_Fem_GP_1	Fixed	-1.546	NA	NA	NA
SR_LN(R0)	Estimated	8.66822	0.07429	6	13
SR_BH_steep	Fixed	0.99	NA	NA	NA
SR_sigmaR	Fixed	0.366875	NA	NA	NA
Early_InitAge_11	Deviation	-0.045084	0.339015	-5	5
Early_InitAge_10	Deviation	0.051318	0.334174	-5	5
Early_InitAge_9	Deviation	0.0322925	0.331883	-5	5
Early_InitAge_8	Deviation	0.197758	0.323304	-5	5
Early_InitAge_7	Deviation	0.477961	0.309126	-5	5
Early_InitAge_6	Deviation	-0.255133	0.329724	-5	5
Early_InitAge_5	Deviation	0.0953901	0.310701	-5	5
Early_InitAge_4	Deviation	-0.042687	0.299169	-5	5
Early_InitAge_3	Deviation	-0.049124	0.268567	-5	5
Early_InitAge_2	Deviation	-0.544779	0.241777	-5	5
Early_InitAge_1	Deviation	-1.05428	0.219041	-5	5
Main_RecrDev_1981	Deviation	-0.417774	0.192702	-5	5
Main_RecrDev_1982	Deviation	-0.141382	0.165132	-5	5
Main_RecrDev_1983	Deviation	-0.114787	0.138962	-5	5
Main_RecrDev_1984	Deviation	0.157352	0.093696	-5	5
Main_RecrDev_1985	Deviation	-0.179478	0.105397	-5	5
Main_RecrDev_1986	Deviation	0.289561	0.095677	-5	5
Main_RecrDev_1987	Deviation	0.160027	0.097664	-5	5
Main_RecrDev_1988	Deviation	-0.470431	0.111385	-5	5
Main_RecrDev_1989	Deviation	0.0413507	0.083432	-5	5
Main_RecrDev_1990	Deviation	0.1814	0.070482	-5	5
Main_RecrDev_1991	Deviation	0.300989	0.060107	-5	5
Main_RecrDev_1992	Deviation	0.0491724	0.058537	-5	5
Main_RecrDev_1993	Deviation	-0.084244	0.055002	-5	5
Main_RecrDev_1994	Deviation	0.304726	0.047753	-5	5
Main_RecrDev_1995	Deviation	-0.476094	0.059042	-5	5
Main_RecrDev_1996	Deviation	-0.01229	0.045678	-5	5
Main_RecrDev_1997	Deviation	-0.267328	0.047237	-5	5
Main_RecrDev_1998	Deviation	-0.211435	0.045937	-5	5
Main_RecrDev_1999	Deviation	-0.632201	0.054325	-5	5
Main_RecrDev_2000	Deviation	0.471304	0.038974	-5	5
Main_RecrDev_2001	Deviation	0.428896	0.039785	-5	5
Main_RecrDev_2002	Deviation	0.515025	0.038351	-5	5
Main_RecrDev_2003	Deviation	0.165893	0.042291	-5	5
Main_RecrDev_2004	Deviation	-0.150181	0.04437	-5	5
Main_RecrDev_2005	Deviation	-0.534024	0.050133	-5	5
Main_RecrDev_2006	Deviation	-0.043205	0.04275	-5	5
Main_RecrDev_2007	Deviation	0.152117	0.041116	-5	5
Main_RecrDev_2008	Deviation	0.241746	0.042537	-5	5
Main_RecrDev_2009	Deviation	0.407454	0.040973	-5	5
Main_RecrDev_2010	Deviation	0.0888281	0.043836	-5	5
Main_RecrDev_2011	Deviation	-0.131647	0.050604	-5	5
Main_RecrDev_2012	Deviation	-0.157429	0.053366	-5	5
Main_RecrDev_2013	Deviation	-0.222322	0.056716	-5	5
Main_RecrDev_2014	Deviation	-0.483486	0.061265	-5	5
Main_RecrDev_2015	Deviation	0.0804919	0.053775	-5	5
Main_RecrDev_2016	Deviation	0.115634	0.054775	-5	5
Main_RecrDev_2017	Deviation	-0.002638	0.055375	-5	5
Main_RecrDev_2018	Deviation	-0.063348	0.055534	-5	5
Main_RecrDev_2019	Deviation	-0.303317	0.061064	-5	5
Main_RecrDev_2020	Deviation	0.198059	0.056487	-5	5
Main_RecrDev_2021	Deviation	0.0651627	0.074081	-5	5
Main_RecrDev_2022	Deviation	0.683855	0.10993	-5	5
ForeRecr_2023	Deviation	0	0.366875	-5	5

**Table 68. Fishing mortality parameter estimates for the southern stock SS base model. SC\_Recreational, GA\_Recreational, and FL\_Recreational are fleets 1, 2, and 3, respectively.**

Parameter	Estimate	SE	Parameter	Estimate	SE
F fleet 1 YR 1981 s 1	0.058	0.025	F fleet 2 YR 2002 s 1	0.087	0.015
F fleet 1 YR 1982 s 1	0.183	0.037	F fleet 2 YR 2003 s 1	0.072	0.012
F fleet 1 YR 1983 s 1	0.058	0.035	F fleet 2 YR 2004 s 1	0.071	0.013
F fleet 1 YR 1984 s 1	0.134	0.049	F fleet 2 YR 2005 s 1	0.112	0.021
F fleet 1 YR 1985 s 1	0.300	0.069	F fleet 2 YR 2006 s 1	0.082	0.016
F fleet 1 YR 1986 s 1	0.080	0.020	F fleet 2 YR 2007 s 1	0.144	0.030
F fleet 1 YR 1987 s 1	0.147	0.033	F fleet 2 YR 2008 s 1	0.100	0.018
F fleet 1 YR 1988 s 1	0.080	0.021	F fleet 2 YR 2009 s 1	0.103	0.017
F fleet 1 YR 1989 s 1	0.066	0.016	F fleet 2 YR 2010 s 1	0.168	0.028
F fleet 1 YR 1990 s 1	0.078	0.025	F fleet 2 YR 2011 s 1	0.071	0.013
F fleet 1 YR 1991 s 1	0.068	0.020	F fleet 2 YR 2012 s 1	0.074	0.016
F fleet 1 YR 1992 s 1	0.048	0.012	F fleet 2 YR 2013 s 1	0.155	0.025
F fleet 1 YR 1993 s 1	0.079	0.021	F fleet 2 YR 2014 s 1	0.230	0.038
F fleet 1 YR 1994 s 1	0.080	0.018	F fleet 2 YR 2015 s 1	0.193	0.034
F fleet 1 YR 1995 s 1	0.138	0.038	F fleet 2 YR 2016 s 1	0.288	0.047
F fleet 1 YR 1996 s 1	0.185	0.053	F fleet 2 YR 2017 s 1	0.327	0.052
F fleet 1 YR 1997 s 1	0.065	0.013	F fleet 2 YR 2018 s 1	0.413	0.068
F fleet 1 YR 1998 s 1	0.076	0.014	F fleet 2 YR 2019 s 1	0.266	0.060
F fleet 1 YR 1999 s 1	0.068	0.015	F fleet 2 YR 2020 s 1	0.187	0.030
F fleet 1 YR 2000 s 1	0.044	0.009	F fleet 2 YR 2021 s 1	0.270	0.048
F fleet 1 YR 2001 s 1	0.079	0.015	F fleet 2 YR 2022 s 1	0.444	0.073
F fleet 1 YR 2002 s 1	0.082	0.016	F fleet 3 YR 1981 s 1	0.186	0.069
F fleet 1 YR 2003 s 1	0.106	0.021	F fleet 3 YR 1982 s 1	0.780	0.304
F fleet 1 YR 2004 s 1	0.089	0.016	F fleet 3 YR 1983 s 1	1.280	0.272
F fleet 1 YR 2005 s 1	0.153	0.027	F fleet 3 YR 1984 s 1	0.734	0.175
F fleet 1 YR 2006 s 1	0.185	0.035	F fleet 3 YR 1985 s 1	0.370	0.099
F fleet 1 YR 2007 s 1	0.142	0.027	F fleet 3 YR 1986 s 1	0.091	0.024
F fleet 1 YR 2008 s 1	0.211	0.040	F fleet 3 YR 1987 s 1	0.144	0.044
F fleet 1 YR 2009 s 1	0.216	0.034	F fleet 3 YR 1988 s 1	0.053	0.014
F fleet 1 YR 2010 s 1	0.336	0.053	F fleet 3 YR 1989 s 1	0.145	0.042
F fleet 1 YR 2011 s 1	0.187	0.029	F fleet 3 YR 1990 s 1	0.125	0.039
F fleet 1 YR 2012 s 1	0.254	0.037	F fleet 3 YR 1991 s 1	0.325	0.089
F fleet 1 YR 2013 s 1	0.251	0.032	F fleet 3 YR 1992 s 1	0.198	0.037
F fleet 1 YR 2014 s 1	0.398	0.067	F fleet 3 YR 1993 s 1	0.244	0.044
F fleet 1 YR 2015 s 1	0.337	0.068	F fleet 3 YR 1994 s 1	0.355	0.069
F fleet 1 YR 2016 s 1	0.372	0.055	F fleet 3 YR 1995 s 1	0.326	0.054
F fleet 1 YR 2017 s 1	0.409	0.063	F fleet 3 YR 1996 s 1	0.248	0.048
F fleet 1 YR 2018 s 1	0.397	0.058	F fleet 3 YR 1997 s 1	0.311	0.056
F fleet 1 YR 2019 s 1	0.619	0.119	F fleet 3 YR 1998 s 1	0.445	0.070
F fleet 1 YR 2020 s 1	0.384	0.062	F fleet 3 YR 1999 s 1	0.516	0.078
F fleet 1 YR 2021 s 1	0.289	0.047	F fleet 3 YR 2000 s 1	0.623	0.094
F fleet 1 YR 2022 s 1	0.236	0.037	F fleet 3 YR 2001 s 1	0.448	0.066
F fleet 2 YR 1981 s 1	0.001	0.001	F fleet 3 YR 2002 s 1	0.422	0.075
F fleet 2 YR 1982 s 1	0.031	0.010	F fleet 3 YR 2003 s 1	0.389	0.062
F fleet 2 YR 1983 s 1	0.114	0.035	F fleet 3 YR 2004 s 1	0.481	0.073
F fleet 2 YR 1984 s 1	0.161	0.041	F fleet 3 YR 2005 s 1	0.600	0.100
F fleet 2 YR 1985 s 1	0.117	0.023	F fleet 3 YR 2006 s 1	0.522	0.082
F fleet 2 YR 1986 s 1	0.082	0.017	F fleet 3 YR 2007 s 1	0.464	0.068
F fleet 2 YR 1987 s 1	0.069	0.014	F fleet 3 YR 2008 s 1	0.464	0.076
F fleet 2 YR 1988 s 1	0.058	0.014	F fleet 3 YR 2009 s 1	0.571	0.077
F fleet 2 YR 1989 s 1	0.061	0.019	F fleet 3 YR 2010 s 1	0.875	0.119
F fleet 2 YR 1990 s 1	0.065	0.016	F fleet 3 YR 2011 s 1	0.569	0.080
F fleet 2 YR 1991 s 1	0.030	0.007	F fleet 3 YR 2012 s 1	0.529	0.065
F fleet 2 YR 1992 s 1	0.058	0.012	F fleet 3 YR 2013 s 1	1.059	0.117
F fleet 2 YR 1993 s 1	0.076	0.016	F fleet 3 YR 2014 s 1	1.117	0.126
F fleet 2 YR 1994 s 1	0.082	0.019	F fleet 3 YR 2015 s 1	1.126	0.127
F fleet 2 YR 1995 s 1	0.061	0.014	F fleet 3 YR 2016 s 1	1.276	0.161
F fleet 2 YR 1996 s 1	0.040	0.010	F fleet 3 YR 2017 s 1	1.110	0.136
F fleet 2 YR 1997 s 1	0.021	0.005	F fleet 3 YR 2018 s 1	1.360	0.156
F fleet 2 YR 1998 s 1	0.029	0.008	F fleet 3 YR 2019 s 1	0.882	0.132
F fleet 2 YR 1999 s 1	0.055	0.012	F fleet 3 YR 2020 s 1	0.765	0.109
F fleet 2 YR 2000 s 1	0.097	0.020	F fleet 3 YR 2021 s 1	1.118	0.238
F fleet 2 YR 2001 s 1	0.085	0.015	F fleet 3 YR 2022 s 1	0.628	0.101

**Table 69. Fishing fleet initial fishing mortality, selectivity, retention, and discard mortality parameters for the southern stock SS base model.**

Parameter	Type	Final Value	SE	Lower Bound	Upper Bound	Prior Type	Prior Mean	Prior sd
InitF_seas_1_flt_1SC_Recreational	Estimated	0.387132	0.282795	0	2	Sym_Beta	NA	1
InitF_seas_1_flt_2GA_Recreational	Estimated	0.384828	0.317247	0	2	Sym_Beta	NA	1
InitF_seas_1_flt_3FL_Recreational	Estimated	0.232793	0.20728	0	2	Sym_Beta	NA	1
Size_DblN_peak_SC_Recreational(1)	Estimated	40.7149	0.907617	25	50	NA	NA	NA
Size_DblN_top_logit_SC_Recreational(1)	Fixed	-0.58	NA	NA	NA	NA	NA	NA
Size_DblN_ascend_se_SC_Recreational(1)	Estimated	4.72891	0.175817	0	6	NA	NA	NA
Size_DblN_descend_se_SC_Recreational(1)	Estimated	2.45946	0.744553	0	6	Sym_Beta	NA	0.5
Size_DblN_start_logit_SC_Recreational(1)	Fixed	-999	NA	NA	NA	NA	NA	NA
Size_DblN_end_logit_SC_Recreational(1)	Estimated	-1.21239	0.21056	-5	5	Normal	-1	0.24
Retain_L_infl_SC_Recreational(1)	Estimated	21.1226	1.40558	20	50	Sym_Beta	NA	0.5
Retain_L_width_SC_Recreational(1)	Estimated	2.80789	1.08471	0.1	10	Sym_Beta	NA	1
Retain_L_asymptote_logit_SC_Recreational(1)	Estimated	6.28367	2.64381	-10	10	Sym_Beta	NA	0.5
Retain_L_dome_infl_SC_Recreational(1)	Estimated	66.7396	1.77653	40	136	NA	NA	NA
Retain_L_dome_width_SC_Recreational(1)	Estimated	7.96906	1.09787	0.1	10	NA	NA	NA
DiscMort_L_level_old_SC_Recreational(1)	Fixed	0.08	NA	NA	NA	NA	NA	NA
Size_DblN_peak_GA_Recreational(2)	Estimated	42.9071	0.915095	25	50	NA	NA	NA
Size_DblN_top_logit_GA_Recreational(2)	Fixed	-0.58	NA	NA	NA	NA	NA	NA
Size_DblN_ascend_se_GA_Recreational(2)	Estimated	4.60169	0.144636	0	6	NA	NA	NA
Size_DblN_descend_se_GA_Recreational(2)	Estimated	1.03493	0.976845	0	6	NA	NA	NA
Size_DblN_start_logit_GA_Recreational(2)	Fixed	-999	NA	NA	NA	NA	NA	NA
Size_DblN_end_logit_GA_Recreational(2)	Estimated	-1.88959	0.271698	-5	5	NA	NA	NA
Retain_L_infl_GA_Recreational(2)	Estimated	18.8152	3.72958	15	50	Sym_Beta	NA	0.5
Retain_L_width_GA_Recreational(2)	Estimated	1.88757	1.27033	0.1	10	Sym_Beta	NA	0.5
Retain_L_asymptote_logit_GA_Recreational(2)	Estimated	7.06166	2.22996	-10	10	Sym_Beta	NA	0.5
Retain_L_dome_infl_GA_Recreational(2)	Estimated	65.2067	2.68031	40	136	NA	NA	NA
Retain_L_dome_width_GA_Recreational(2)	Estimated	4.55004	1.20427	0.001	10	NA	NA	NA
DiscMort_L_level_old_GA_Recreational(2)	Fixed	0.08	NA	NA	NA	NA	NA	NA
Size_DblN_peak_FL_Recreational(3)	Estimated	40.9572	0.669004	25	50	NA	NA	NA
Size_DblN_top_logit_FL_Recreational(3)	Fixed	-0.58	NA	NA	NA	NA	NA	NA
Size_DblN_ascend_se_FL_Recreational(3)	Estimated	4.56213	0.1512	0	6	NA	NA	NA
Size_DblN_descend_se_FL_Recreational(3)	Estimated	1.22613	0.560544	0	6	Sym_Beta	NA	0.5
Size_DblN_start_logit_FL_Recreational(3)	Fixed	-999	NA	NA	NA	NA	NA	NA
Size_DblN_end_logit_FL_Recreational(3)	Estimated	-2.26866	0.286901	-5	5	NA	NA	NA
Retain_L_infl_FL_Recreational(3)	Estimated	16.8056	2.31528	15	60	Sym_Beta	NA	0.5
Retain_L_width_FL_Recreational(3)	Estimated	3.92246	1.80195	0.1	10	NA	NA	NA
Retain_L_asymptote_logit_FL_Recreational(3)	Estimated	6.42745	2.5716	-10	10	Sym_Beta	NA	0.5
Retain_L_dome_infl_FL_Recreational(3)	Estimated	76.1535	4.84684	40	136	NA	NA	NA
Retain_L_dome_width_FL_Recreational(3)	Estimated	9.45392	1.94115	0.001	14	NA	NA	NA
DiscMort_L_level_old_FL_Recreational(3)	Fixed	0.08	NA	NA	NA	NA	NA	NA
Retain_L_infl_SC_Recreational(1)_BLK1repl_1990	Estimated	34.593	0.65595	20	50	NA	NA	NA
Retain_L_infl_SC_Recreational(1)_BLK1repl_2001	Estimated	38.9051	0.26932	20	50	NA	NA	NA
Retain_L_width_SC_Recreational(1)_BLK1repl_1990	Estimated	2.68908	0.366486	0.1	10	NA	NA	NA
Retain_L_width_SC_Recreational(1)_BLK1repl_2001	Estimated	1.09461	0.144402	0.1	10	NA	NA	NA
Retain_L_asymptote_logit_SC_Recreational(1)_BLK8repl_1990	Estimated	5.93546	2.83576	-10	10	Sym_Beta	NA	0.5
Retain_L_asymptote_logit_SC_Recreational(1)_BLK8repl_2001	Estimated	0.542263	0.291827	-10	10	NA	NA	NA
Retain_L_asymptote_logit_SC_Recreational(1)_BLK8repl_2007	Estimated	-0.133363	0.15997	-10	10	NA	NA	NA
Retain_L_asymptote_logit_SC_Recreational(1)_BLK8repl_2018	Estimated	-0.558014	0.166308	-10	10	NA	NA	NA
Retain_L_dome_infl_SC_Recreational(1)_BLK2repl_1993	Estimated	55.4332	1.63726	40	136	NA	NA	NA
Retain_L_dome_infl_SC_Recreational(1)_BLK2repl_2001	Estimated	59.5762	0.434335	40	136	NA	NA	NA
Retain_L_dome_width_SC_Recreational(1)_BLK2repl_1993	Estimated	6.29844	0.718631	0.001	10	NA	NA	NA
Retain_L_dome_width_SC_Recreational(1)_BLK2repl_2001	Estimated	1.91983	0.230264	0.001	10	NA	NA	NA
Retain_L_infl_GA_Recreational(2)_BLK7repl_1986	Estimated	39.4127	0.227114	20	50	NA	NA	NA
Retain_L_width_GA_Recreational(2)_BLK7repl_1986	Estimated	1.65524	0.113136	0.1	10	NA	NA	NA
Retain_L_dome_infl_GA_Recreational(2)_BLK4repl_1986	Estimated	53.4486	1.35859	40	136	NA	NA	NA
Retain_L_dome_infl_GA_Recreational(2)_BLK4repl_1993	Estimated	58.9747	1.45055	40	136	NA	NA	NA
Retain_L_dome_infl_GA_Recreational(2)_BLK4repl_2002	Estimated	53.3712	0.5714	40	136	NA	NA	NA
Retain_L_dome_width_GA_Recreational(2)_BLK4repl_1986	Estimated	7.08237	0.6724	0.001	10	NA	NA	NA
Retain_L_dome_width_GA_Recreational(2)_BLK4repl_1993	Estimated	6.5589	0.740943	0.001	10	NA	NA	NA
Retain_L_dome_width_GA_Recreational(2)_BLK4repl_2002	Estimated	4.2685	0.277171	0.001	10	NA	NA	NA
Retain_L_infl_FL_Recreational(3)_BLK9repl_1985	Estimated	52.5329	0.629955	20	60	NA	NA	NA
Retain_L_width_FL_Recreational(3)_BLK9repl_1985	Estimated	3.80333	0.192994	0.1	10	NA	NA	NA
Retain_L_asymptote_logit_FL_Recreational(3)_BLK6repl_1989	Estimated	0.0451433	0.180606	-10	10	Sym_Beta	NA	2
Retain_L_dome_infl_FL_Recreational(3)_BLK6repl_1989	Estimated	72.1848	1.2567	40	136	NA	NA	NA
Retain_L_dome_width_FL_Recreational(3)_BLK6repl_1989	Estimated	5.03376	0.738374	0.001	10	NA	NA	NA

**Table 70. Survey catchability coefficient and selectivity parameters for the southern stock SS base model.**

Parameter	Type	Final Value	SE	Lower Bound	Upper Bound	Prior Type	Prior Mean	Prior sd
LnQ_base_FL_21.3_HaulSeine(4)	Derived	-8.57384	NA	NA	NA	NA	NA	NA
LnQ_base_SC_Rotenone(5)	Derived	-8.76956	NA	NA	NA	NA	NA	NA
LnQ_base_GA_GillNet(6)	Derived	-8.25778	NA	NA	NA	NA	NA	NA
LnQ_base_SC_StopNet(7)	Derived	-8.77237	NA	NA	NA	NA	NA	NA
LnQ_base_SC_Trammel(9)	Derived	-8.46373	NA	NA	NA	NA	NA	NA
LnQ_base_FL_183_HaulSeine(10)	Derived	-8.39557	NA	NA	NA	NA	NA	NA
LnQ_base_SC_Longline_contemporary(11)	Derived	-7.46883	NA	NA	NA	NA	NA	NA
Size_inflection_SC_Longline_contemporary(11)	Fixed	91.5	NA	NA	NA	NA	NA	NA
Size_95%width_SC_Longline_contemporary(11)	Fixed	9	NA	NA	NA	NA	NA	NA
minage@sel=1_GA_GillNet(6)	Fixed	0	NA	NA	NA	NA	NA	NA
maxage@sel=1_GA_GillNet(6)	Fixed	0	NA	NA	NA	NA	NA	NA
Age_DblN_peak_SC_StopNet(7)	Estimated	1.08048	0.161872	0.1	2.75	NA	NA	NA
Age_DblN_top_logit_SC_StopNet(7)	Estimated	-7.05522	5.29895	-15	3	Sym Beta	NA	0.5
Age_DblN_ascend_se_SC_StopNet(7)	Estimated	0.43009	0.350238	0.001	4	Sym Beta	NA	0.5
Age_DblN_descend_se_SC_StopNet(7)	Estimated	0.415558	0.350364	0.001	4	Sym Beta	NA	0.7
Age_DblN_start_logit_SC_StopNet(7)	Fixed	-999	NA	NA	NA	NA	NA	NA
Age_DblN_end_logit_SC_StopNet(7)	Fixed	-999	NA	NA	NA	NA	NA	NA
Age_DblN_peak_SC_Trammel(9)	Estimated	1.87335	0.054628	0.1	2.75	NA	NA	NA
Age_DblN_top_logit_SC_Trammel(9)	Estimated	-11.2942	2.68111	-15	3	Sym Beta	NA	0.5
Age_DblN_ascend_se_SC_Trammel(9)	Estimated	0.635266	0.038162	0.1	1	NA	NA	NA
Age_DblN_descend_se_SC_Trammel(9)	Estimated	0.477555	0.046565	0.1	4	NA	NA	NA
Age_DblN_start_logit_SC_Trammel(9)	Fixed	-999	NA	NA	NA	NA	NA	NA
Age_DblN_end_logit_SC_Trammel(9)	Fixed	-999	NA	NA	NA	NA	NA	NA
Age_DblN_peak_FL_183_HaulSeine(10)	Estimated	1.3099	0.039454	0.1	1.8	NA	NA	NA
Age_DblN_top_logit_FL_183_HaulSeine(10)	Estimated	-10.9402	5.47114	-13	3	Sym Beta	NA	0.05
Age_DblN_ascend_se_FL_183_HaulSeine(10)	Estimated	0.0531751	0.031727	0.001	4	Sym Beta	NA	2.5
Age_DblN_descend_se_FL_183_HaulSeine(10)	Estimated	0.176639	0.104857	0.001	4	Sym Beta	NA	0.5
Age_DblN_start_logit_FL_183_HaulSeine(10)	Fixed	-999	NA	NA	NA	NA	NA	NA
Age_DblN_end_logit_FL_183_HaulSeine(10)	Fixed	-999	NA	NA	NA	NA	NA	NA

**Table 71. Jitter analysis results for the southern stock SS model. The -LL column shows the change in total negative log-likelihood relative to the base model.**

-LL	Δ -LL	Frequency	Converged?
7,345	0	192	Yes
7,352	7	1	Yes
7,352	7	1	Yes
7,366	22	1	Yes
9,093	1,748	1	No
9,698	2,353	1	No
9,925	2,580	1	No
13,533	6,188	1	No
22,632	15,287	1	No

**Table 72. Beginning of fishing year abundance estimates (in 1000s of fish) for the southern stock SS base model.**

Year	0	1	2	3	4	5	6	7	8	9	10	11	12	13	14	15	16	17	18	19	20+	Total
1981	3,548	966	498	318	168	130	72	122	76	54	46	35	31	26	22	18	15	13	11	9	53	6,231
1982	4,664	2,053	559	325	226	130	107	60	103	64	45	39	30	26	22	18	16	13	11	9	54	8,575
1983	4,766	2,301	630	202	151	140	99	86	49	85	53	38	32	25	22	18	15	13	11	9	54	8,801
1984	6,214	2,158	481	155	71	82	102	78	69	40	69	44	31	27	21	18	15	13	11	9	53	9,764
1985	4,408	3,073	647	171	72	44	62	83	64	57	33	58	37	26	23	17	15	13	11	9	53	8,977
1986	7,017	2,435	1,457	302	95	49	35	51	68	53	48	28	49	31	22	19	15	13	11	9	54	11,859
1987	6,183	4,185	1,538	1,000	222	75	41	29	43	58	45	40	24	41	26	19	16	13	11	9	54	13,672
1988	3,314	3,624	2,493	979	696	170	61	34	24	36	49	38	34	20	35	22	16	14	11	10	55	11,734
1989	5,574	1,979	2,330	1,770	741	556	141	51	29	21	31	41	32	29	17	30	19	14	12	9	55	13,482
1990	6,449	3,335	1,275	1,633	1,327	591	461	119	43	24	18	26	35	28	25	15	26	16	12	10	56	15,524
1991	7,295	3,896	2,147	893	1,225	1,059	490	388	100	36	21	15	22	30	24	21	13	22	14	10	57	17,776
1992	5,681	4,398	2,509	1,415	635	953	872	411	326	84	31	17	13	19	26	20	18	11	19	12	58	17,528
1993	4,977	3,437	2,878	1,745	1,051	505	790	733	346	276	72	26	15	11	16	22	17	16	9	16	60	17,018
1994	7,350	2,999	2,170	1,939	1,276	830	418	664	618	293	234	61	22	13	9	14	19	15	13	8	66	19,029
1995	3,369	4,419	1,861	1,394	1,367	990	683	350	558	522	248	198	52	19	11	8	12	16	13	11	63	16,163
1996	5,360	2,017	2,676	1,195	986	1,062	815	572	294	471	441	210	168	44	16	9	7	10	14	11	64	16,442
1997	4,154	3,202	1,209	1,759	863	774	876	683	481	248	398	374	178	143	37	14	8	6	9	12	65	15,494
1998	4,394	2,507	2,084	818	1,280	680	640	736	576	407	210	338	318	152	122	32	12	7	5	7	66	15,391
1999	2,885	2,642	1,587	1,328	568	986	559	536	619	486	344	178	287	271	130	104	27	10	6	4	63	13,621
2000	8,698	1,733	1,645	974	897	432	807	467	450	522	411	292	151	244	231	110	89	23	9	5	58	18,248
2001	8,335	5,220	1,059	957	633	670	352	673	391	379	441	348	247	129	208	196	94	76	20	7	54	20,490
2002	9,084	5,028	3,260	658	658	485	550	294	565	330	321	373	295	210	110	177	168	81	65	17	53	22,783
2003	6,406	5,481	3,148	2,078	461	509	399	460	248	477	279	272	317	251	179	93	151	143	69	56	60	21,539
2004	4,671	3,867	3,436	2,026	1,469	358	419	334	387	209	404	237	231	270	214	153	80	129	123	59	99	19,173
2005	3,183	2,816	2,417	2,144	1,395	1,126	294	350	281	326	177	342	201	196	230	182	130	68	111	105	136	16,209
2006	5,201	1,910	1,653	1,394	1,405	1,044	916	244	293	236	275	149	289	170	167	195	155	111	58	95	206	16,168
2007	6,324	3,124	1,133	981	935	1,064	852	764	205	247	199	232	126	245	145	142	166	132	95	50	258	17,420
2008	6,917	3,803	1,867	692	670	714	871	711	641	172	208	168	197	107	209	123	121	142	113	81	263	18,791
2009	8,162	4,156	2,271	1,134	472	511	584	726	596	539	145	176	143	167	91	177	105	103	121	96	295	20,770
2010	5,934	4,894	2,443	1,320	747	354	416	485	607	500	454	123	149	121	142	77	151	89	88	103	335	19,531
2011	4,759	3,522	2,578	1,198	774	530	282	342	403	506	419	381	103	125	102	120	65	128	76	74	373	16,860
2012	4,637	2,857	2,126	1,523	795	582	431	235	287	339	427	354	322	87	106	87	102	56	109	65	383	15,912
2013	4,346	2,781	1,691	1,253	1,016	599	474	359	197	241	285	360	299	273	74	90	74	87	48	93	384	15,025
2014	3,346	2,577	1,486	791	701	705	476	390	298	164	201	239	303	252	230	63	77	62	74	40	406	12,883
2015	5,880	1,972	1,252	641	424	476	555	389	322	247	137	168	200	254	212	194	53	65	53	62	379	13,936
2016	6,087	3,472	995	552	346	289	376	455	322	268	206	114	141	169	214	179	164	45	55	45	375	14,868
2017	5,405	3,574	1,622	399	281	229	226	306	374	266	223	172	96	118	141	180	150	138	38	46	356	14,341
2018	5,083	3,177	1,647	681	212	190	180	185	252	310	222	186	144	80	99	119	152	127	116	32	341	13,534
2019	3,995	2,971	1,399	623	332	137	147	146	151	208	257	185	155	120	67	83	100	127	107	98	316	11,725
2020	6,591	2,350	1,402	634	352	230	109	120	120	125	173	214	154	130	101	56	70	84	107	90	350	13,564
2021	5,768	3,915	1,250	716	383	253	184	89	100	100	105	145	180	130	110	85	48	59	71	91	375	14,159
2022	10,703	3,406	1,967	554	387	261	199	151	74	83	84	88	122	152	109	92	72	40	50	60	396	19,052



**Table 73. Female spawning stock biomass estimates for the southern stock SS base model. 95% confidence intervals are based on asymptotic standard errors.**

Year	Annual SSB (metric tons)			Annual Relative SSB			Three-Year Average Relative SSB
	LCI	Estimate	UCI	LCI	Estimate	UCI	
Unfished	28,235	33,252	38,269	NA	NA	NA	NA
Target	11,303	13,250	15,198	NA	NA	NA	NA
Threshold	8,459	9,917	11,374	NA	1.000	NA	1.000
1981	1,306	2,629	3,951	0.146	0.264	0.381	NA
1982	1,419	2,729	4,039	0.158	0.274	0.389	NA
1983	1,421	2,646	3,871	0.158	0.265	0.372	0.267
1984	1,320	2,421	3,521	0.147	0.243	0.338	0.260
1985	1,239	2,240	3,240	0.139	0.225	0.310	0.244
1986	1,201	2,143	3,085	0.136	0.215	0.294	0.227
1987	1,358	2,327	3,296	0.155	0.233	0.312	0.224
1988	1,736	2,898	4,060	0.202	0.291	0.379	0.246
1989	2,470	4,055	5,640	0.292	0.406	0.521	0.310
1990	3,484	5,681	7,879	0.416	0.570	0.723	0.422
1991	4,622	7,504	10,387	0.557	0.752	0.948	0.576
1992	5,517	8,977	12,437	0.669	0.900	1.131	0.741
1993	6,289	10,147	14,004	0.766	1.017	1.269	0.890
1994	7,111	11,345	15,579	0.868	1.137	1.407	1.018
1995	7,968	12,640	17,313	0.975	1.267	1.559	1.141
1996	8,683	13,730	18,777	1.065	1.376	1.688	1.260
1997	9,165	14,443	19,722	1.125	1.448	1.771	1.364
1998	9,546	14,956	20,366	1.172	1.499	1.827	1.441
1999	9,728	15,200	20,672	1.195	1.524	1.853	1.490
2000	9,700	15,144	20,587	1.192	1.518	1.844	1.514
2001	9,452	14,787	20,121	1.162	1.482	1.802	1.508
2002	9,266	14,481	19,695	1.139	1.452	1.764	1.484
2003	9,148	14,243	19,337	1.124	1.428	1.731	1.454
2004	9,395	14,502	19,609	1.153	1.454	1.754	1.444
2005	10,002	15,330	20,658	1.226	1.537	1.847	1.473
2006	10,571	16,219	21,867	1.296	1.626	1.956	1.539
2007	10,855	16,704	22,553	1.331	1.674	2.018	1.612
2008	10,791	16,632	22,474	1.324	1.667	2.011	1.656
2009	10,441	16,089	21,736	1.281	1.613	1.945	1.652
2010	10,053	15,456	20,859	1.233	1.549	1.866	1.610
2011	9,591	14,805	20,018	1.177	1.484	1.792	1.549
2012	9,484	14,606	19,728	1.163	1.464	1.766	1.499
2013	9,504	14,567	19,630	1.164	1.460	1.757	1.470
2014	9,233	14,184	19,135	1.131	1.422	1.713	1.449
2015	8,700	13,445	18,189	1.067	1.348	1.629	1.410
2016	8,028	12,474	16,920	0.985	1.250	1.516	1.340
2017	7,275	11,366	15,457	0.894	1.139	1.385	1.246
2018	6,605	10,350	14,094	0.812	1.037	1.263	1.142
2019	5,952	9,398	12,845	0.732	0.942	1.152	1.040
2020	5,481	8,705	11,929	0.675	0.873	1.070	0.951
2021	5,199	8,276	11,353	0.641	0.830	1.019	0.881
2022	4,919	7,878	10,837	0.607	0.790	0.973	0.831

**Table 74. Age-2 fishing mortality (F) and spawning potential ratio (SPR) estimates for the southern stock SS base model. 95% confidence intervals are based on asymptotic standard errors.**

Year	Age-2 F			Annual SPR			Three-Year Average SPR
	LCI	Estimate	UCI	LCI	Estimate	UCI	
Target	0.290	0.301	0.311	NA	0.400	NA	0.400
Threshold	0.382	0.396	0.410	NA	0.300	NA	0.300
1981	0.074	0.193	0.312	0.272	0.487	0.701	NA
1982	0.293	0.785	1.276	-0.042	0.056	0.154	NA
1983	0.709	1.168	1.626	-0.009	0.015	0.039	0.186
1984	0.496	0.802	1.109	-0.006	0.055	0.115	0.042
1985	0.332	0.530	0.728	0.058	0.169	0.280	0.080
1986	0.086	0.143	0.200	0.491	0.612	0.733	0.279
1987	0.127	0.219	0.311	0.323	0.470	0.617	0.417
1988	0.063	0.109	0.156	0.565	0.679	0.794	0.587
1989	0.070	0.122	0.174	0.553	0.667	0.781	0.605
1990	0.068	0.124	0.180	0.549	0.671	0.793	0.672
1991	0.101	0.184	0.267	0.435	0.577	0.719	0.638
1992	0.086	0.130	0.175	0.578	0.671	0.764	0.640
1993	0.109	0.162	0.215	0.507	0.607	0.708	0.618
1994	0.138	0.210	0.281	0.416	0.532	0.648	0.603
1995	0.141	0.210	0.279	0.401	0.518	0.634	0.552
1996	0.118	0.186	0.255	0.414	0.541	0.669	0.530
1997	0.105	0.157	0.209	0.528	0.626	0.724	0.562
1998	0.153	0.218	0.283	0.423	0.526	0.629	0.564
1999	0.182	0.255	0.329	0.370	0.475	0.579	0.542
2000	0.222	0.309	0.395	0.307	0.413	0.518	0.471
2001	0.177	0.243	0.309	0.401	0.498	0.595	0.462
2002	0.150	0.217	0.285	0.422	0.527	0.633	0.479
2003	0.149	0.208	0.267	0.445	0.541	0.638	0.522
2004	0.172	0.238	0.305	0.400	0.500	0.599	0.523
2005	0.224	0.317	0.411	0.284	0.393	0.502	0.478
2006	0.207	0.289	0.371	0.321	0.426	0.531	0.439
2007	0.192	0.260	0.328	0.360	0.456	0.551	0.425
2008	0.193	0.266	0.338	0.350	0.448	0.547	0.443
2009	0.237	0.310	0.382	0.309	0.397	0.484	0.434
2010	0.366	0.480	0.593	0.157	0.240	0.322	0.362
2011	0.219	0.293	0.366	0.329	0.422	0.515	0.353
2012	0.232	0.295	0.359	0.332	0.413	0.494	0.358
2013	0.424	0.526	0.629	0.149	0.216	0.282	0.350
2014	0.489	0.608	0.728	0.105	0.164	0.224	0.264
2015	0.470	0.586	0.702	0.116	0.179	0.241	0.186
2016	0.542	0.680	0.818	0.080	0.134	0.188	0.159
2017	0.514	0.636	0.757	0.094	0.148	0.202	0.153
2018	0.592	0.739	0.887	0.060	0.109	0.159	0.130
2019	0.423	0.558	0.693	0.103	0.178	0.252	0.145
2020	0.333	0.439	0.544	0.179	0.264	0.348	0.184
2021	0.383	0.580	0.777	0.079	0.179	0.279	0.207
2022	0.311	0.424	0.537	0.168	0.262	0.356	0.235

**Table 75. Input data types for traffic light analysis characteristics selected for the red drum TLA framework and the stock status each characteristic is used to indicate.**

Characteristic	Input Data Type	Stock Status
Recruitment	Recruitment (age-1) index of abundance	Recruitment Condition
Adult Abundance	Longline Survey of adult abundance	Spawning Stock Biomass
Fishery Performance	Harvest of slot-sized fish divided by slot-sized index of abundance	Fishing Mortality

**Table 76. Data sources for each traffic light analysis characteristic selected for the red drum TLA framework.**

Characteristic	Northern	Southern
Recruitment	NC_BagSeine	FL_21.3_HaulSeine
Adult Abundance	NC_Longline	GA_Longline SC_Longline_contemporary
Fishery Performance	NC_Gillnet	FL_183_HaulSeine SC_Trammel

**Table 77. Threshold values for the northern stock optimized from the grid square method. The estimated threshold for adult abundance, 0.78, was halved to serve as a more conservative metric for the assessment.**

Characteristics	Years to Trigger Management Action	Threshold
Recruitment	1	0.05
Adult Abundance	10	0.78 (0.39)
Fishery Performance	7	0.76

**Table 78. Threshold values for the southern stock optimized from the grid square method. The estimated threshold for adult abundance, 0.78, was halved to serve as a more conservative metric for the assessment.**

Characteristics	Years to Trigger Management Action	Threshold
Recruitment	1	0.05
Adult Abundance	9	0.78 (0.39)
Fishery Performance	6	0.52

**Table 79. Action results derived from the TLA model for the northern stock. The terminal fishing year used for stock status in the assessment is 2021.**

Year	Recruitment	Adult_Abundance	Fishery_Performance
2018	No Action	No Action	Moderate Action
2019	Moderate Action	No Action	Moderate Action
2020	Moderate Action	No Action	Moderate Action
<b>2021</b>	<b>Moderate Action</b>	<b>No Action</b>	<b>Moderate Action</b>

**Table 80. Action results derived from the TLA model for the southern stock. The terminal fishing year used for stock status in the assessment is 2021.**

Year	Recruitment	Adult_Abundance	Fishery_Performance
<b>2018</b>	Elevated Action	Moderate Action	Elevated Action
<b>2019</b>	Elevated Action	Moderate Action	Elevated Action
<b>2020</b>	Elevated Action	Moderate Action	Elevated Action
<b>2021</b>	<b>Elevated Action</b>	<b>Moderate Action</b>	<b>Elevated Action</b>

**Table 81. Action results for the northern stock based on sensitivity runs evaluating changes in duration of reference period. A total of 8 different scenarios were evaluated. Results including the base reference period are in bold.**

Recruitment	Adult_Abundance	Fishery_Performance	Frequency
<b>Moderate Action</b>	<b>No Action</b>	<b>Moderate Action</b>	<b>6</b>
Moderate Action	No Action	Elevated Action	2

**Table 82. Action results for the southern stock based on sensitivity runs evaluating changes in duration of reference period. A total of 11 different scenarios were evaluated. Results including the base reference period are in bold.**

Recruitment	Adult_Abundance	Fishery_Performance	Frequency
<b>Elevated Action</b>	<b>Moderate Action</b>	<b>Elevated Action</b>	<b>4</b>
Elevated Action	No Action	Elevated Action	7

**Table 83. NCDMF gill net survey red drum index (annual; 3-yr avg), MRIP North Carolina and areas north recreational harvest plus North Carolina commercial harvest (annual; 3-yr avg.), normalized catch:index ratio ( $Catch/Index_{norm,y}$ ), recommended catch ( $Catch/Index_{norm,y}$ ), and proportion change in catch relative to previous year as estimated using Skate methodology by fishing year. Bolded values indicate years with recommended catch reductions.**

Fishing Year	Index		MRIP Landings (mt)		$Catch/$ $Index_{norm,y}$	$C_{rec,y}$	$Catch \Delta$
	Annual	3-yr Avg	Annual	3-yr Avg			
2002	-	-	450	-	-	-	-
2003	1.6536	-	256	-	-	-	-
2004	6.0570	-	125	277	-	-	-
2005	6.5471	4.7526	399	260	0.3112	835	2.0185
2006	3.6748	5.4263	501	342	0.3585	953	2.6686
2007	2.1338	4.1186	703	534	0.7386	724	1.1169
2008	4.7824	3.5303	534	579	0.9342	620	0.1606
2009	4.5960	3.8374	786	674	1.0000	674	0.1636
2010	5.1413	4.8399	465	595	0.6998	850	0.2612
2011	0.7280	3.4884	523	591	0.9646	613	0.0299
	11.958						
2012	2	5.9425	779	589	0.5641	1044	0.7661
2013	5.6985	6.1282	1964	1089	1.0110	1077	0.8281
2014	3.5947	7.0838	607	1117	0.8972	1245	0.1433
2015	3.1350	4.1427	293	955	1.3114	728	<b>-0.3482</b>
2016	4.1374	3.6224	1096	665	1.0450	636	<b>-0.3332</b>
2017	2.4912	3.2545	1165	851	1.4885	572	<b>-0.1402</b>
2018	1.4726	2.7004	383	881	1.8573	474	<b>-0.4426</b>
2019	6.1438	3.3692	772	773	1.3062	592	<b>-0.3282</b>
2020	5.2320	4.2828	1531	895	1.1894	752	<b>-0.0268</b>
2021	4.3201	5.2320	1301	1201	1.3067	919	0.0271
2022*	2.6617	4.0713	725	1186	1.6576	715	<b>-0.4045</b>

\* - Note, data not used in estimation of relative F to be consistent with other analyses presented herein

**Table 84. SCDNR trammel net age-2 and -3 red drum index (annual; 3-yr avg), MRIP South Carolina recreational harvest (annual; 3-yr avg.), normalized catch:index ratio ( $Catch/Index_{norm,y}$ ), recommended catch ( $Catch/Index_{norm,y}$ ), and proportion change in catch relative to previous year as estimated using Skate methodology by fishing year. Bolded values indicate years with recommended catch reductions.**

Fishing Year	MRIP Landings (mt)				$Catch/Index_{norm,y}$	$C_{rec,y}$	Catch $\Delta$
	Index		Annual	3-yr Avg			
	Annual	3-yr Avg					
1990	-	-	469	-	-	-	-
	10.704						
1991	4	-	415	-	-	-	-
1992	6.9499	-	451	445	-	-	-
1993	8.5922	8.7488	379	415	0.4841	858	0.9259
1994	4.8725	6.8049	152	327	0.4909	667	0.6068
1995	5.9990	6.4879	515	348	0.5479	636	0.9424
1996	3.3751	4.7489	449	372	0.7990	465	0.3360
1997	2.3806	3.9182	271	412	1.0720	384	0.0326
1998	2.8241	2.8599	221	314	1.1201	280	<b>-0.3191</b>
1999	1.3920	2.1989	154	216	1.0000	216	<b>-0.3136</b>
2000	2.8232	2.3464	100	158	0.6885	230	0.0671
2001	5.8165	3.3439	192	149	0.4533	328	1.0698
2002	4.0192	4.2196	217	170	0.4101	414	1.7837
2003	5.3573	5.0643	364	258	0.5192	496	1.9268
2004	4.8220	4.7328	227	270	0.5811	464	0.7999
2005	4.8801	5.0198	279	290	0.5895	492	0.8252
2006	2.3181	4.0067	165	224	0.5698	393	0.3540
2007	2.8977	3.3653	174	206	0.6245	330	0.4740
2008	2.3609	2.5256	240	193	0.7800	248	0.2018
2009	4.4808	3.2465	335	250	0.7847	318	0.6480
2010	2.3925	3.0781	610	395	1.3096	302	0.2083
2011	1.8807	2.9180	280	409	1.4286	286	<b>-0.2761</b>
2012	1.3845	1.8859	532	474	2.5653	185	<b>-0.5476</b>
2013	1.6180	1.6277	238	350	2.1941	160	<b>-0.6635</b>
2014	1.2617	1.4214	426	398	2.8599	139	<b>-0.6020</b>
2015	1.0553	1.3117	300	321	2.4988	129	<b>-0.6773</b>
2016	0.7976	1.0382	397	374	3.6765	102	<b>-0.6832</b>
2017	1.4418	1.0982	368	355	3.2966	108	<b>-0.7123</b>
2018	1.1869	1.1421	315	360	3.2136	112	<b>-0.6845</b>
2019	0.5204	1.0497	347	343	3.3376	103	<b>-0.7140</b>
2020	1.4517	1.0530	264	309	2.9932	103	<b>-0.6994</b>
2021	0.6881	0.8867	242	285	3.1618	90	<b>-0.7085</b>
2022*	1.5751	1.2383	260	256	2.0324	126	<b>-0.5583</b>

\* - Note, data not used in estimation of relative F to be consistent with other analyses presented herein

**Table 85. FL FWRI 183 m haul seine red drum index (annual; 3-yr avg), MRIP Florida recreational harvest (annual; 3-yr avg.), normalized catch:index ratio ( $Catch/Index_{norm,y}$ ), recommended catch ( $Catch/Index_{norm,y}$ ), and proportion change in catch relative to previous year as estimated using Skate methodology by fishing year. Bolded values indicate years with recommended catch reductions.**

Fishing Year	Index		MRIP Landings (mt)		$Catch/Index_{norm,y}$	$C_{rec,y}$	Catch $\Delta$
	Annual	3-yr Avg	Annual	3-yr Avg			
2000	-	-	1449	-	-	-	-
2001	0.00849	-	941	-	-	-	-
2002	0.00623	-	1245	1211	-	-	-
2003	0.01212	0.00895	1085	1090	0.5582	1953	0.6121
2004	0.00793	0.00876	1044	1124	0.5880	1912	0.7542
2005	0.00940	0.00982	1093	1074	0.5011	2143	0.9056
2006	0.00441	0.00725	1064	1067	0.6744	1582	0.4730
2007	0.00581	0.00654	706	954	0.6686	1427	0.3381
2008	0.00457	0.00493	802	857	0.7967	1076	0.1277
2009	0.00975	0.00671	1362	957	0.6530	1465	0.7087
2010	0.00791	0.00741	1247	1137	0.7029	1617	0.6906
2011	0.00598	0.00788	1455	1354	0.7876	1720	0.5127
2012	0.00525	0.00638	1474	1392	1.0000	1392	0.0276
2013	0.00317	0.00480	2343	1757	1.6779	1047	<b>-0.2475</b>
2014	0.00381	0.00408	2050	1956	2.1983	890	<b>-0.4937</b>
2015	0.00361	0.00353	1479	1957	2.5399	771	<b>-0.6059</b>
2016	0.00369	0.00371	2734	2088	2.5811	809	<b>-0.5868</b>
2017	0.00274	0.00335	1810	2008	2.7462	731	<b>-0.6498</b>
2018	0.00459	0.00368	2348	2297	2.8637	802	<b>-0.6004</b>
2019	0.00256	0.00330	895	1684	2.3400	720	<b>-0.6867</b>
2020	0.00339	0.00351	944	1395	1.8201	767	<b>-0.5448</b>
2021	0.00604	0.00400	1107	982	1.1257	872	<b>-0.3749</b>
2022*	0.00736	0.00560	585	879	0.7193	1222	0.2441

\* - Note, data not used in estimation of relative F to be consistent with other analyses presented herein

11 FIGURES

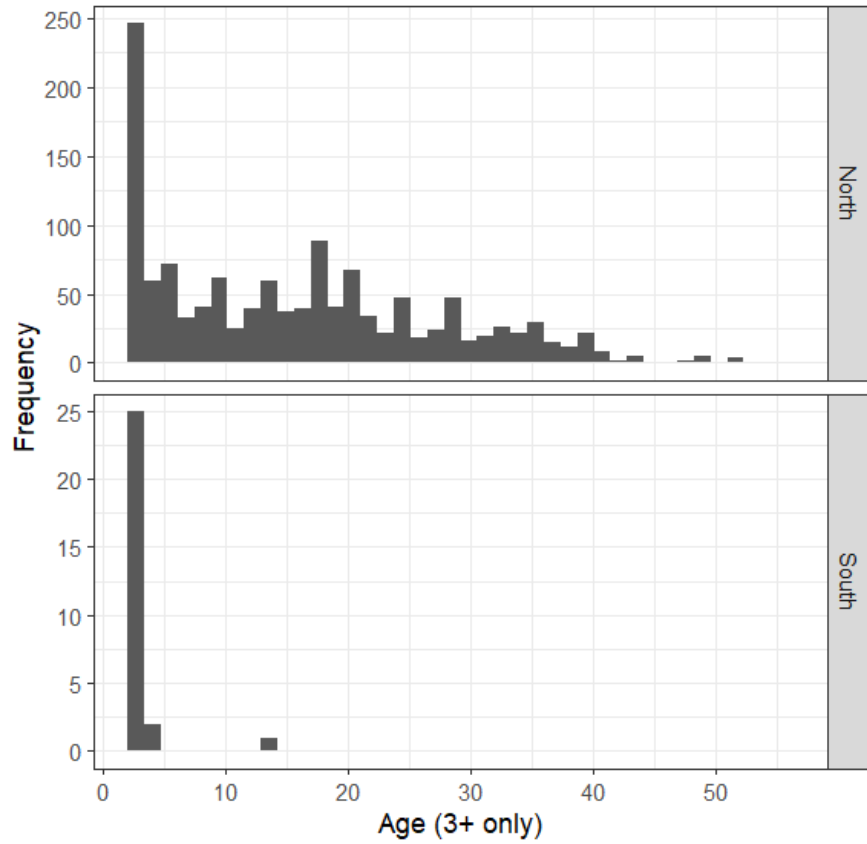


Figure 1. Age frequency of red drum captured north of the White Oak River in North Carolina versus within and south of the White Oak River for ages 3+.

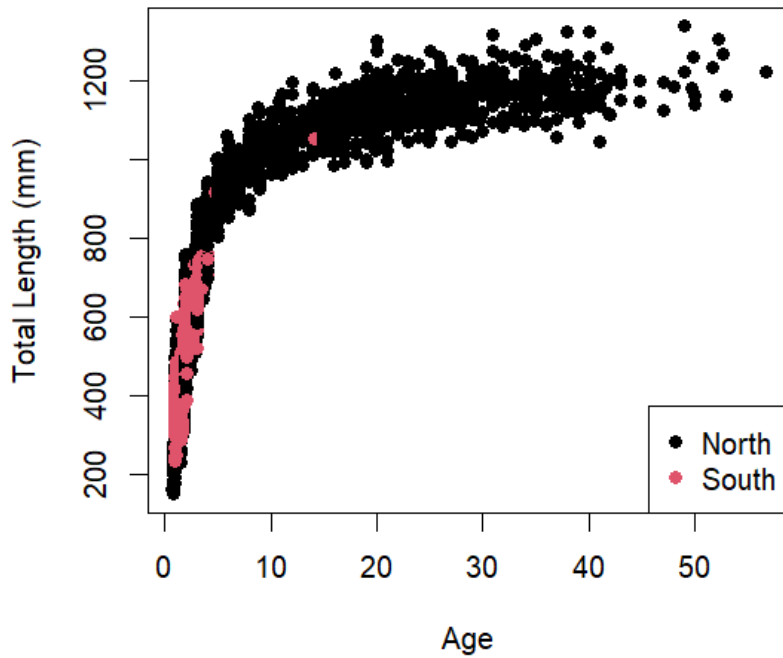
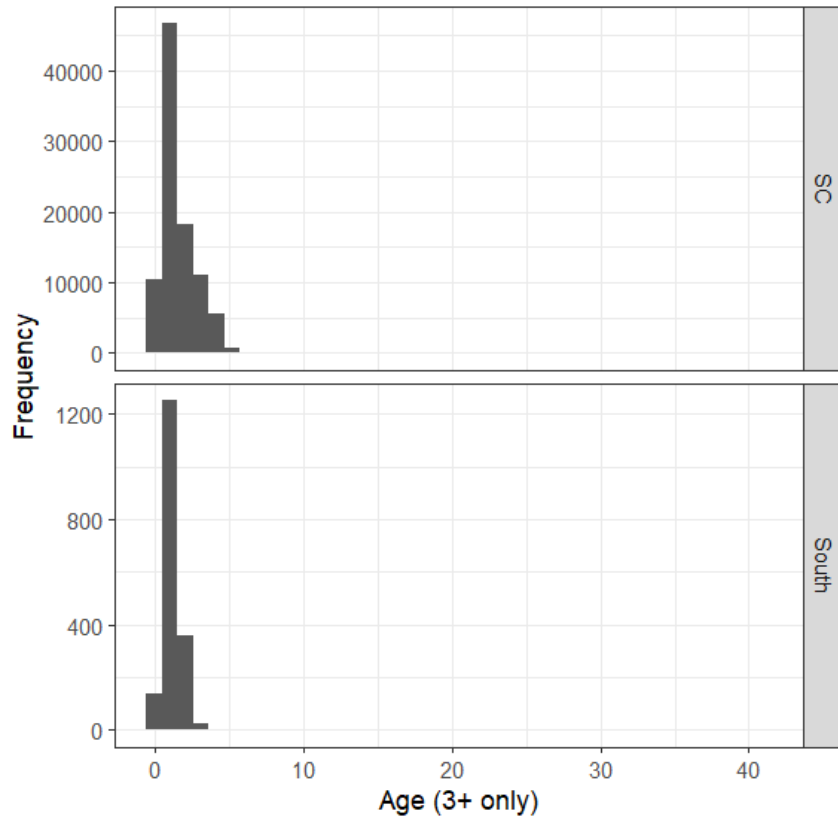
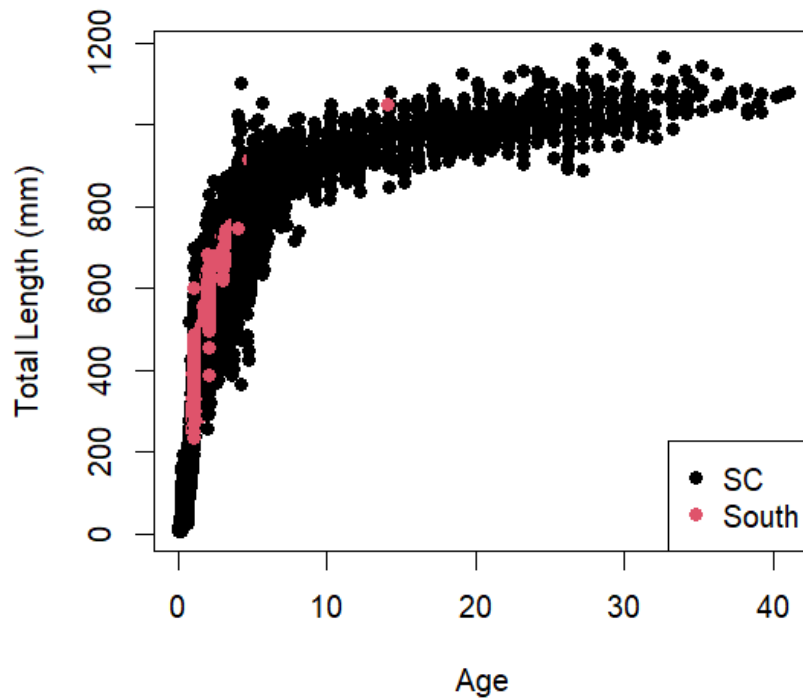


Figure 2. Fit of the von Bertalanffy age-length model to available biological data for red drum captured north of the White Oak River (black dots) and within or south of the White Oak River (red dots).

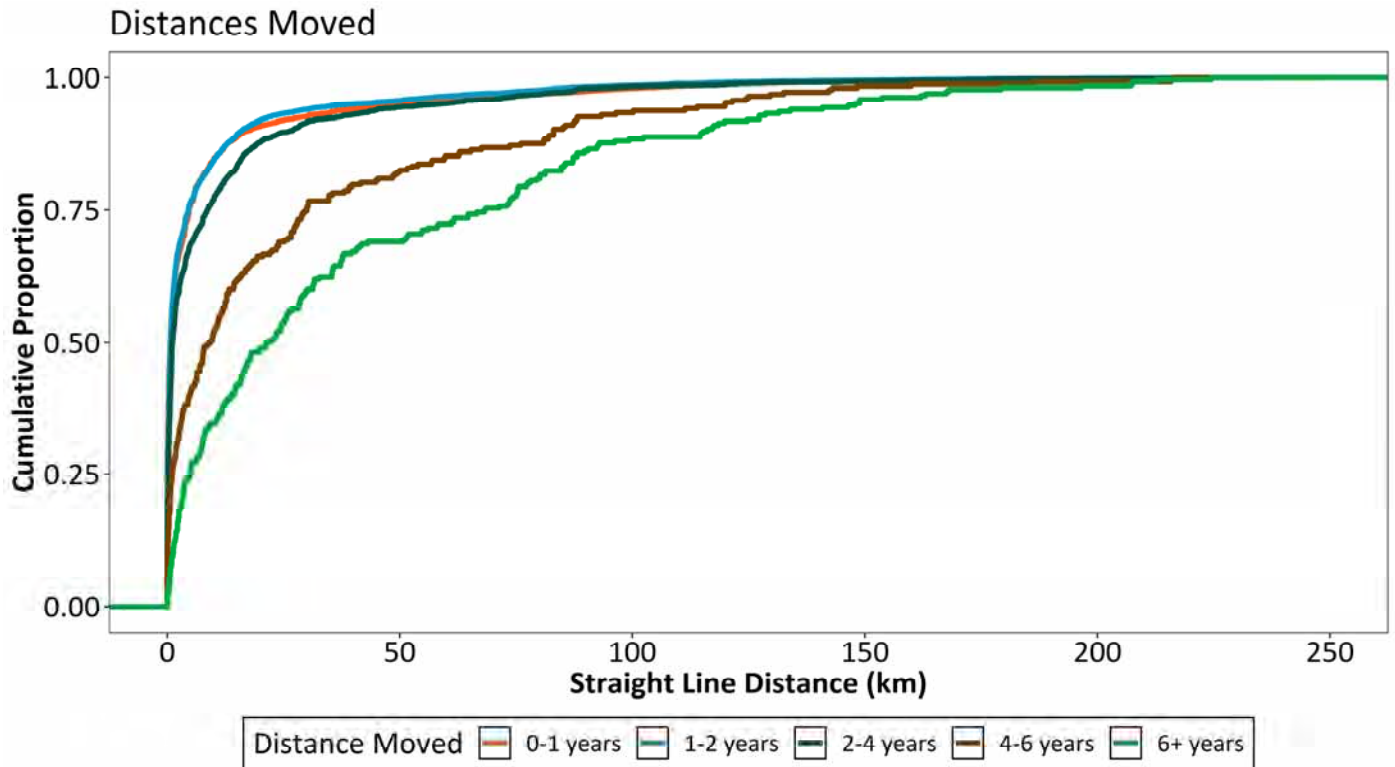




**Figure 3. Age frequency of red drum captured in South Carolina and red drum captured south of the White Oak River in North Carolina for ages 3+.**



**Figure 4. Fit of Von Bertalanffy age-length model to available biological data for red drum captured in South Carolina (black dots) and red drum captured south of the White Oak River in North Carolina (red dots).**



**Figure 5. Cumulative proportion of tag recaptures as a function of straight line distance (km) and time-at-large. Time-at-large is split into 5 groups, 0-1 years (orange), 1-2 years (blue), 2-4 years (dark green), 4-6 years (brown), and 6+ years (light green). Fish were tagged as part of SCDNR’s Marine Gamefish Tagging and fishery-independent tagging programs.**

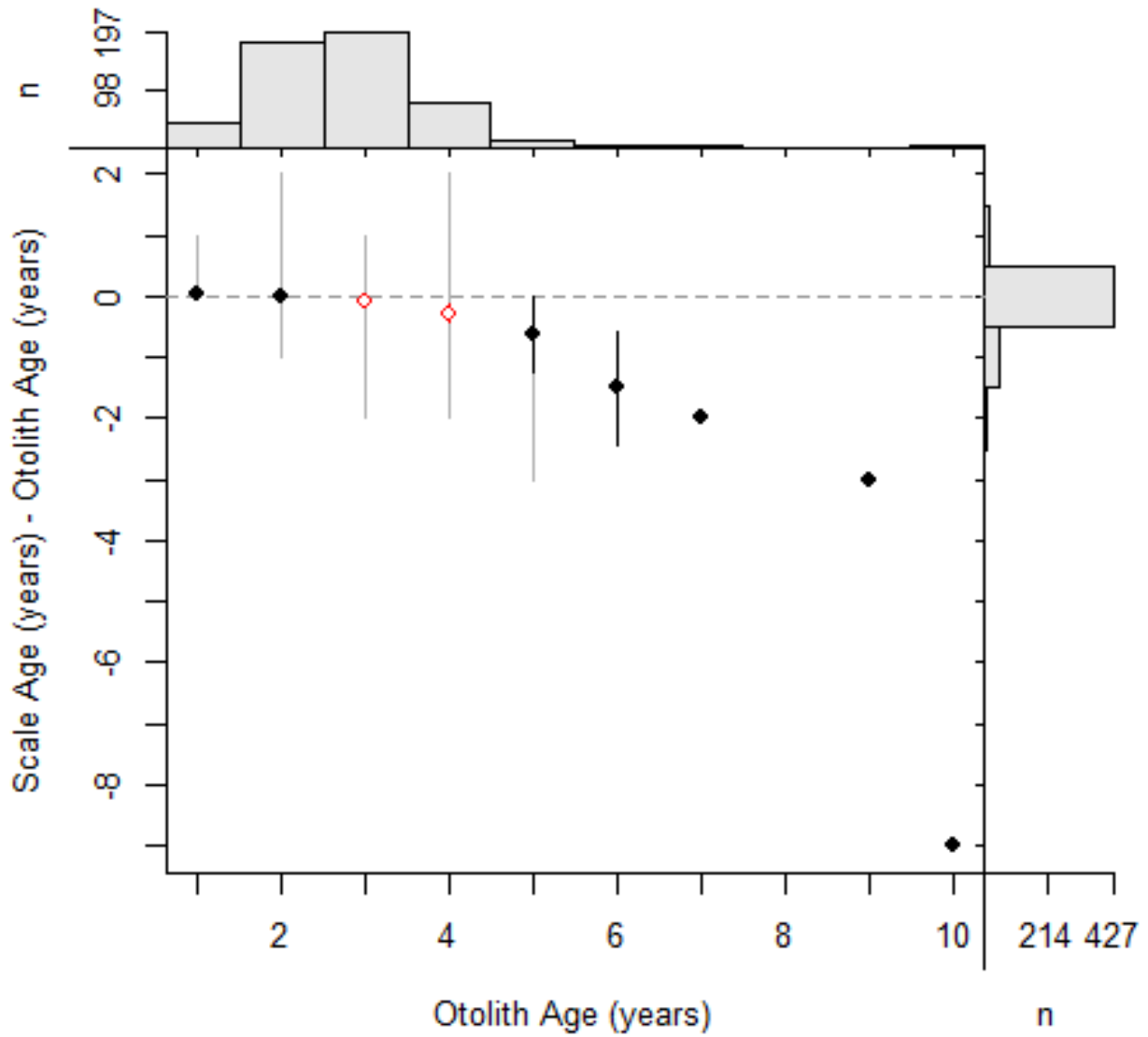
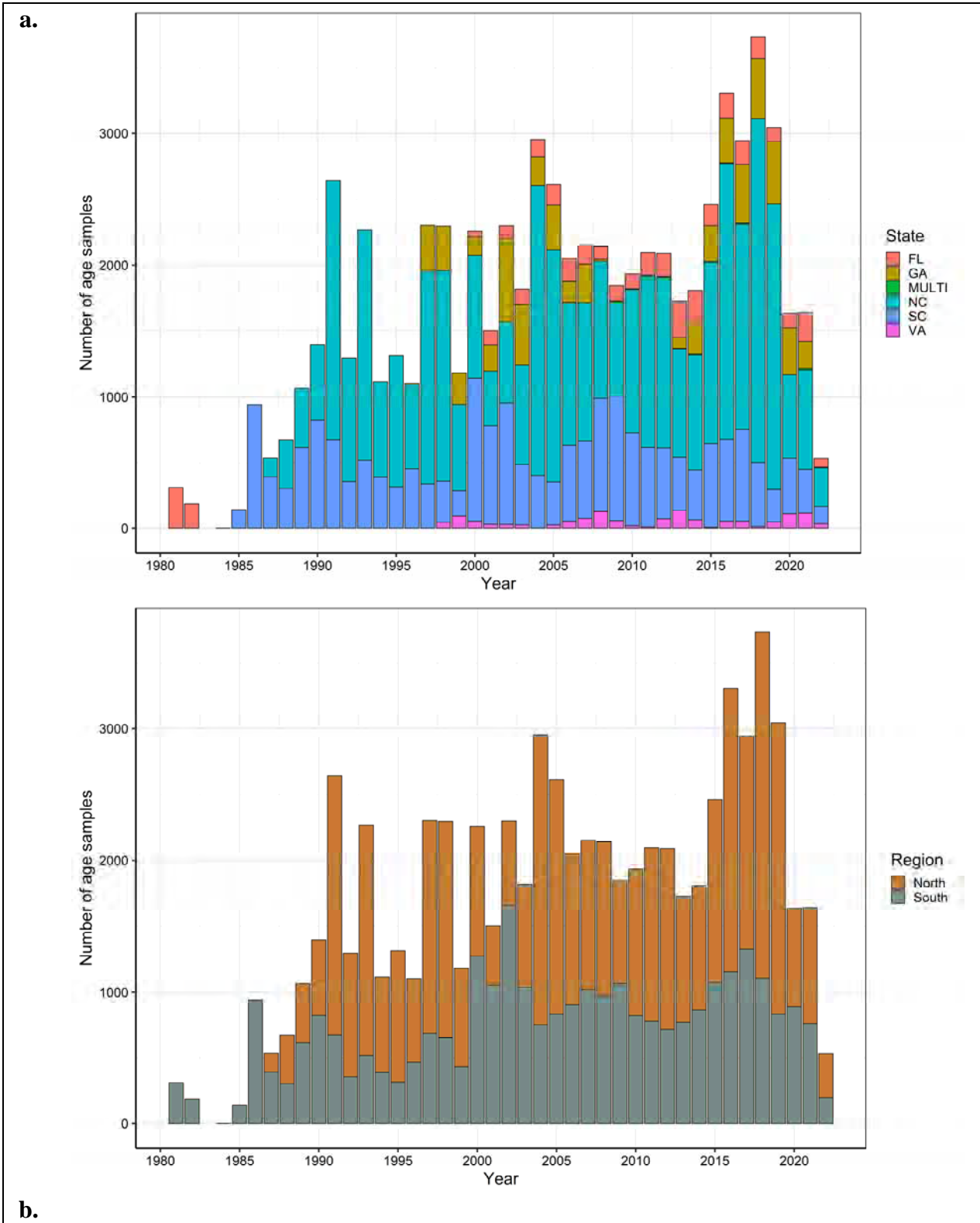
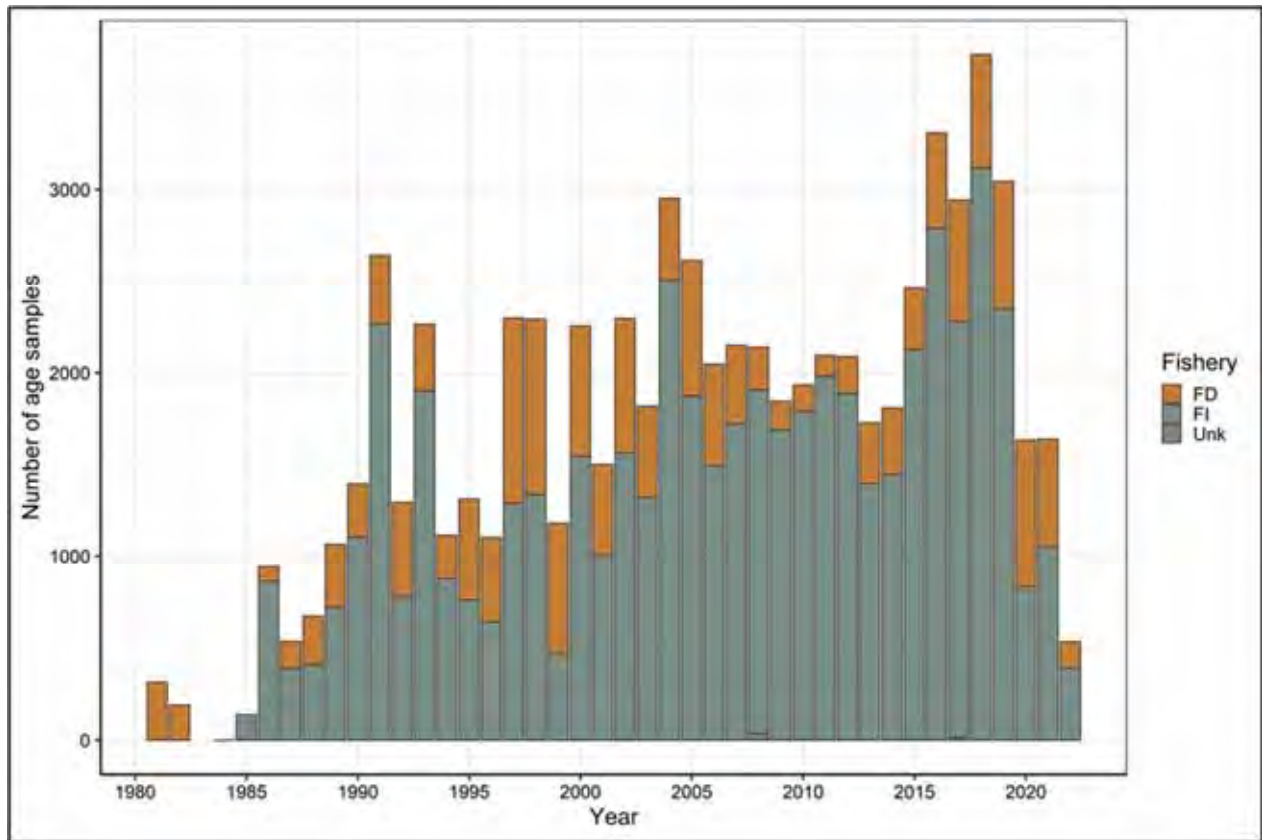


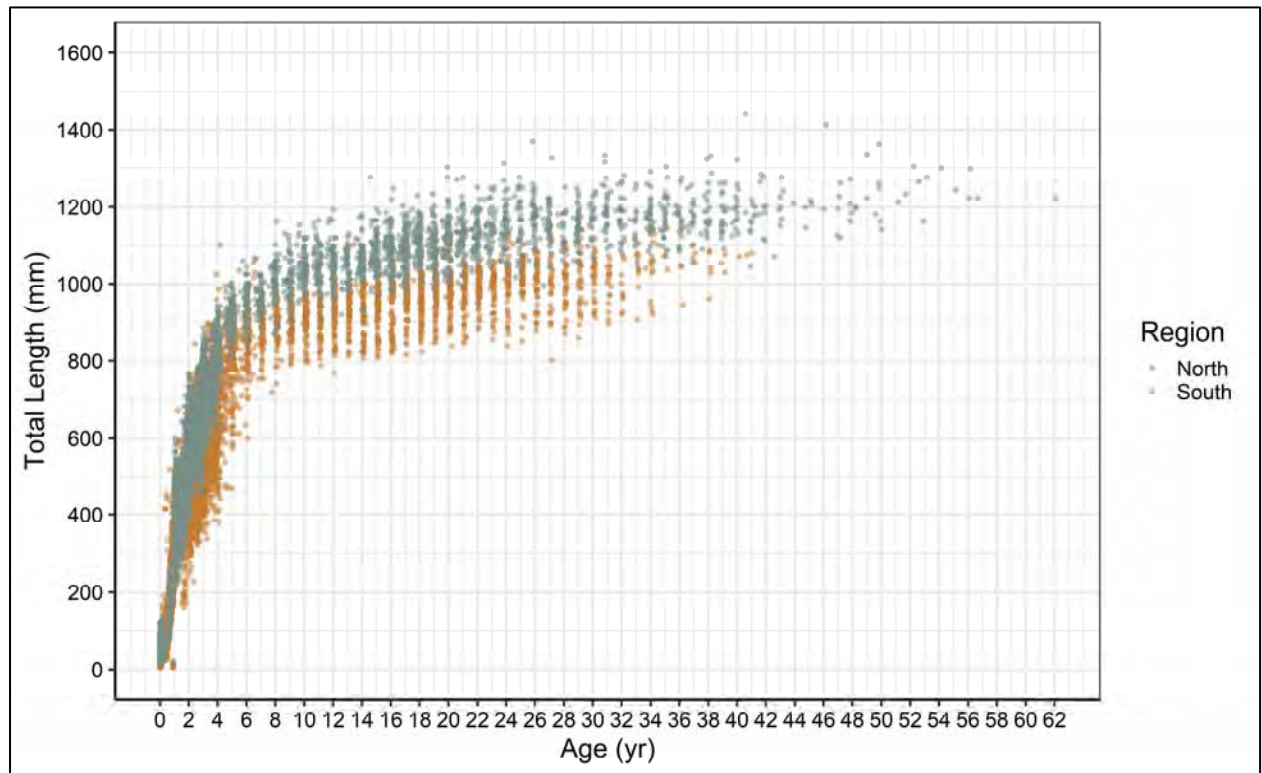
Figure 6. Age bias plot depicting the mean difference in scale - otolith derived ages for a given otolith derived age. Provided are the mean difference (symbol), 95% CI (black bars) and range of difference in age determinations (gray bars). Marginal histograms are provided showing the numbers of individuals given a particular age based on otolith (top histogram) and scale (right histogram) reads.



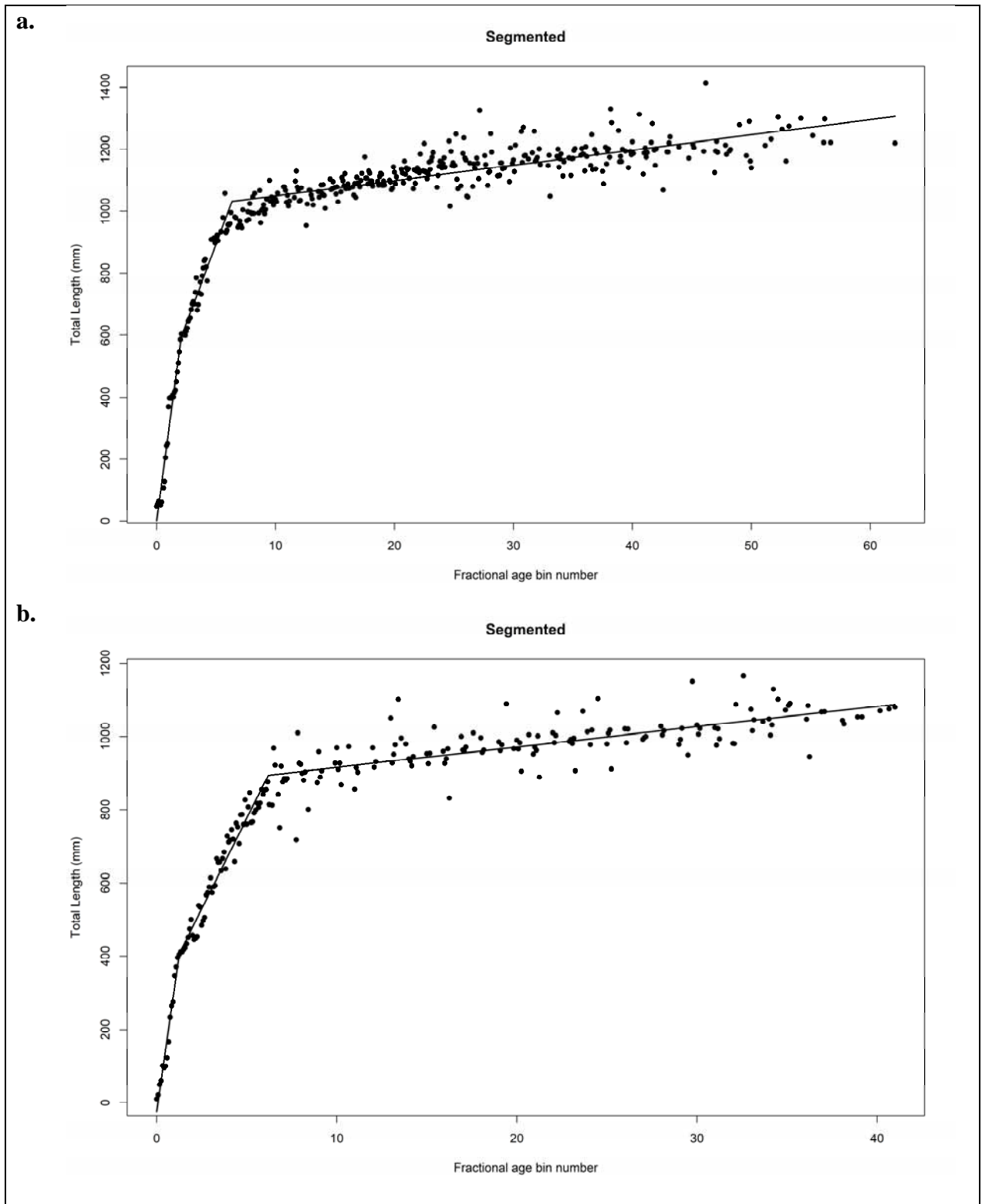
**Figure 7. Number of red drum age samples collected by stock/region (a.) and by state (b.) on the Atlantic coast of the U.S. from 1981 – 2022.**



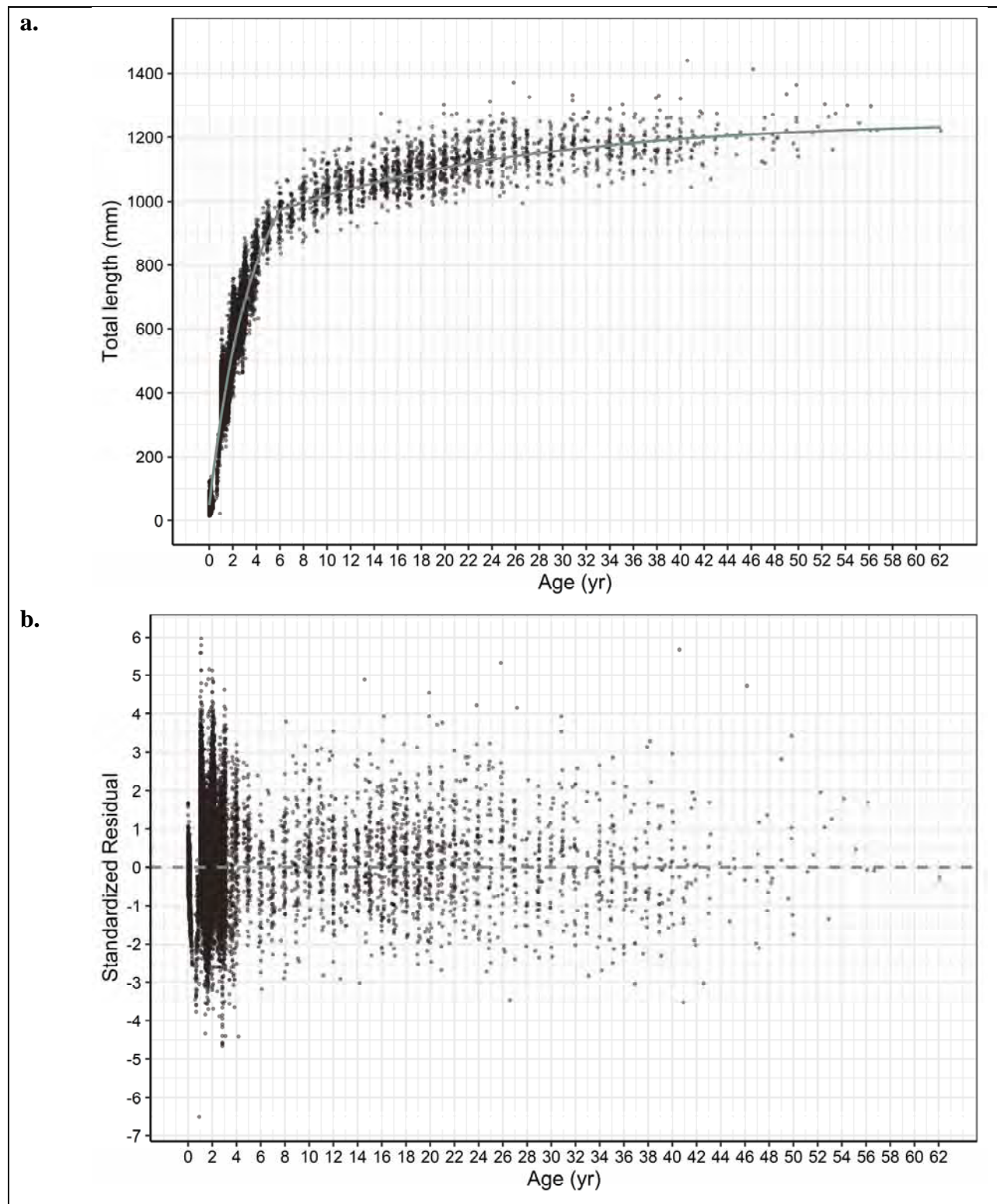
**Figure 8. Number of red drum age samples collected by fishery dependent and fishery independent sources on the Atlantic coast of the U.S. from 1981 – 2022.**



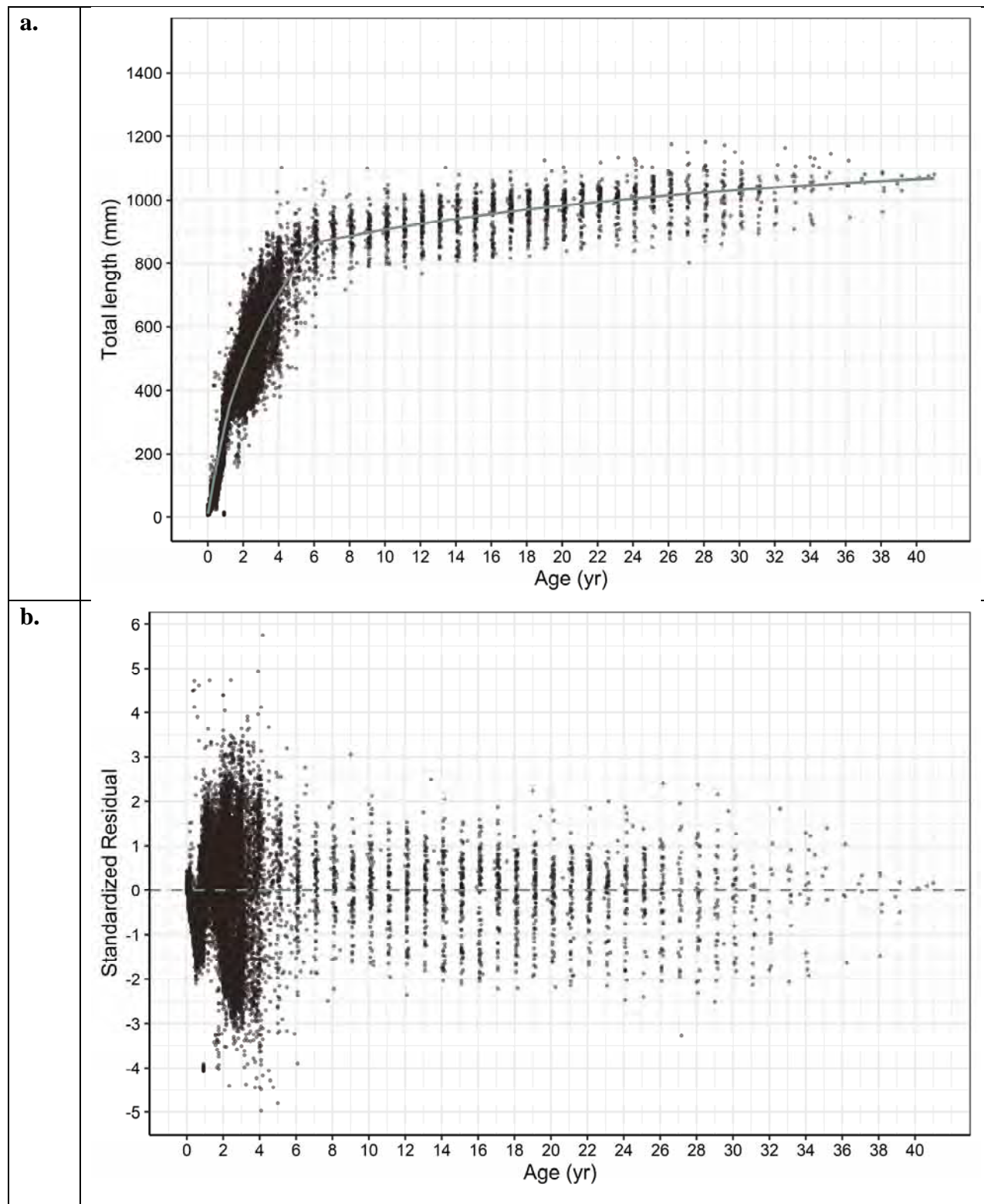
**Figure 9. Scatterplot of the length-at-age by stock/region for red drum collected on the Atlantic coast of the U.S. from 1981 – 2022.**



**Figure 10. Segmented regression on red drum biological mean length-at-age by stock. (a) northern and (b) southern.**



**Figure 11. Red drum length-at-age data collected from the northern stock of the Atlantic coast of the U.S. (a) the age-varying  $K$  growth model (blue line) as applied to the red drum length-at-age data and (b) the residuals from the model fit to the length-at-age data.**



**Figure 12. Red drum length-at-age data collected from the southern stock of the Atlantic coast of the U.S. (a) the age-varying  $K$  growth model (blue line) as applied to the red drum length-at-age data and (b) the residuals from the model fit to the length-at-age data.**



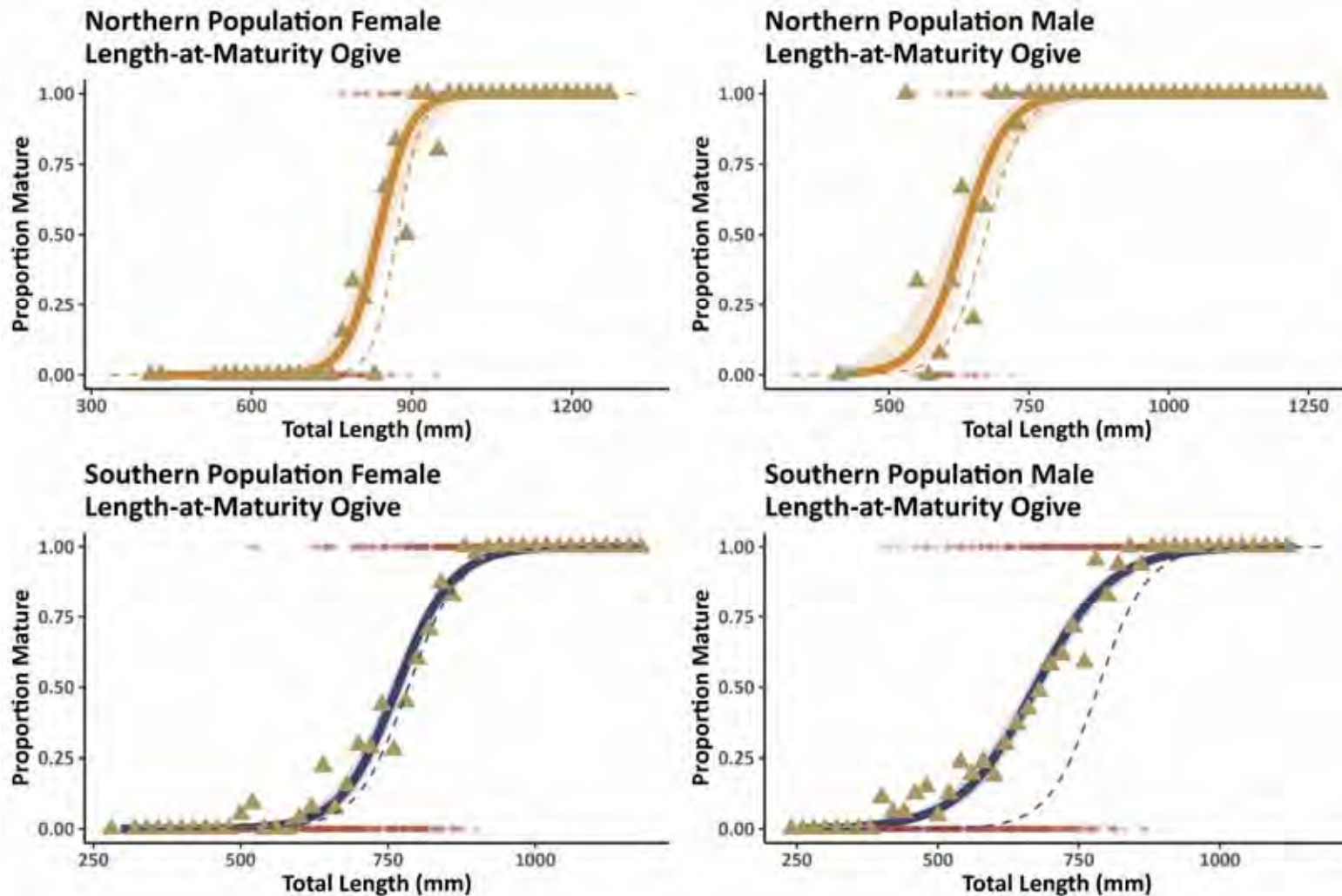


Figure 13. Best fit length-at-maturity ogives for female (left panels) and male (right panels) red drum from the southern (bottom panels; solid blue line) and northern (upper panels; solid orange line) stocks. Shaded regions represent 95% confidence interval about the ogive. Dashed lines are the maturity ogives presented in SEDAR 44. Red dots are maturity (0 = immature; 1 = mature) of individual fish and gold triangles represent observed proportion mature by 20 mm TL bin.

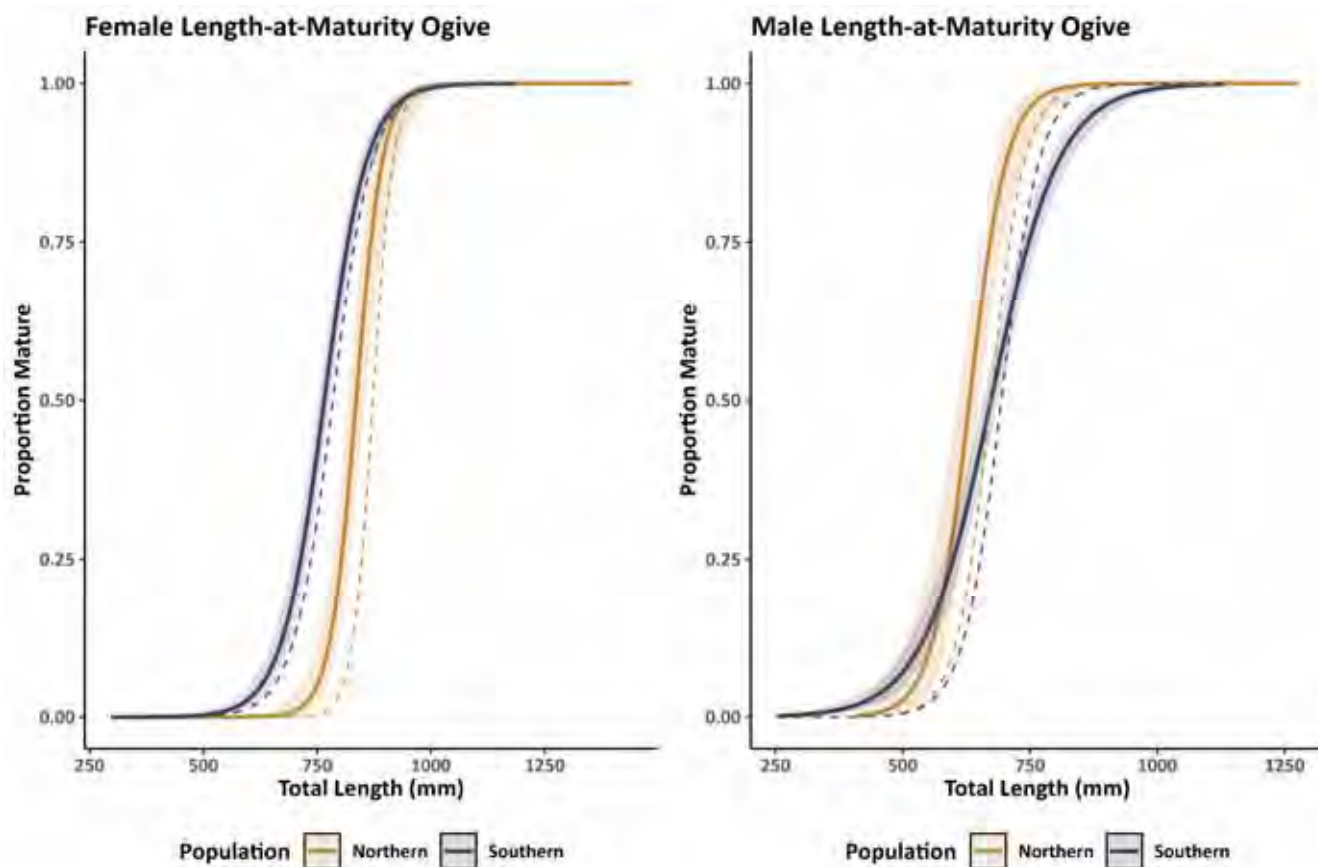


Figure 14. Best fit length-at-maturity ogives for female (left panel) and male (right panel) red drum from the southern (solid blue line) and northern (solid orange line) stocks. Shaded regions represent 95% confidence interval about the ogive. Dashed lines are the maturity ogives presented in SEDAR 44.

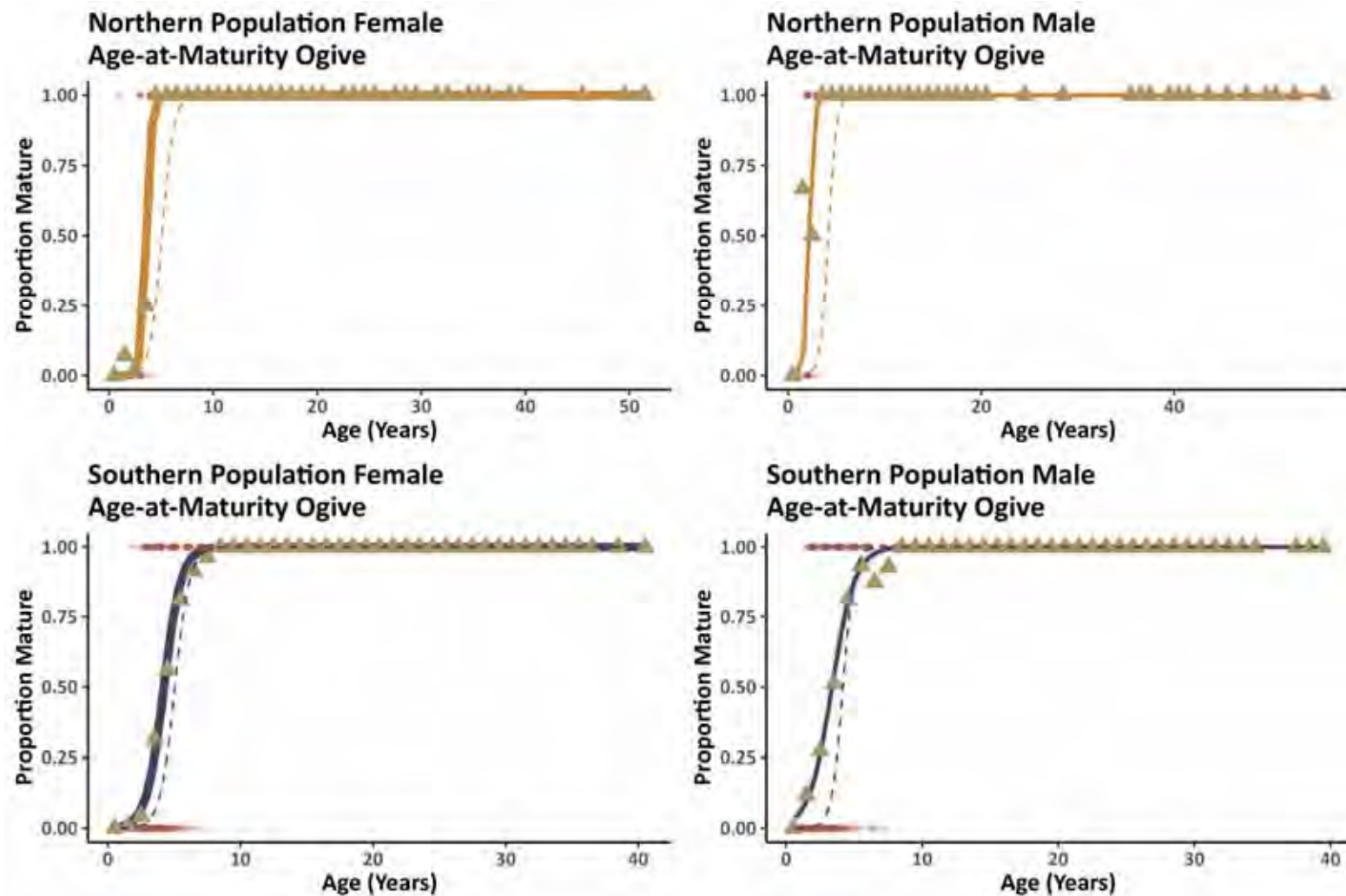


Figure 15. Best fit age-at-maturity ogives for female (left panels) and male (right panels) red drum from the southern (bottom panels; solid blue line) and northern (upper panels; solid orange line) stocks. Shaded regions represent 95% confidence interval about the ogive. Dashed lines are the maturity ogives presented in SEDAR 44. Red dots are maturity (0 = immature; 1 = mature) of individual fish and gold triangles represent observed proportion mature by age bin.

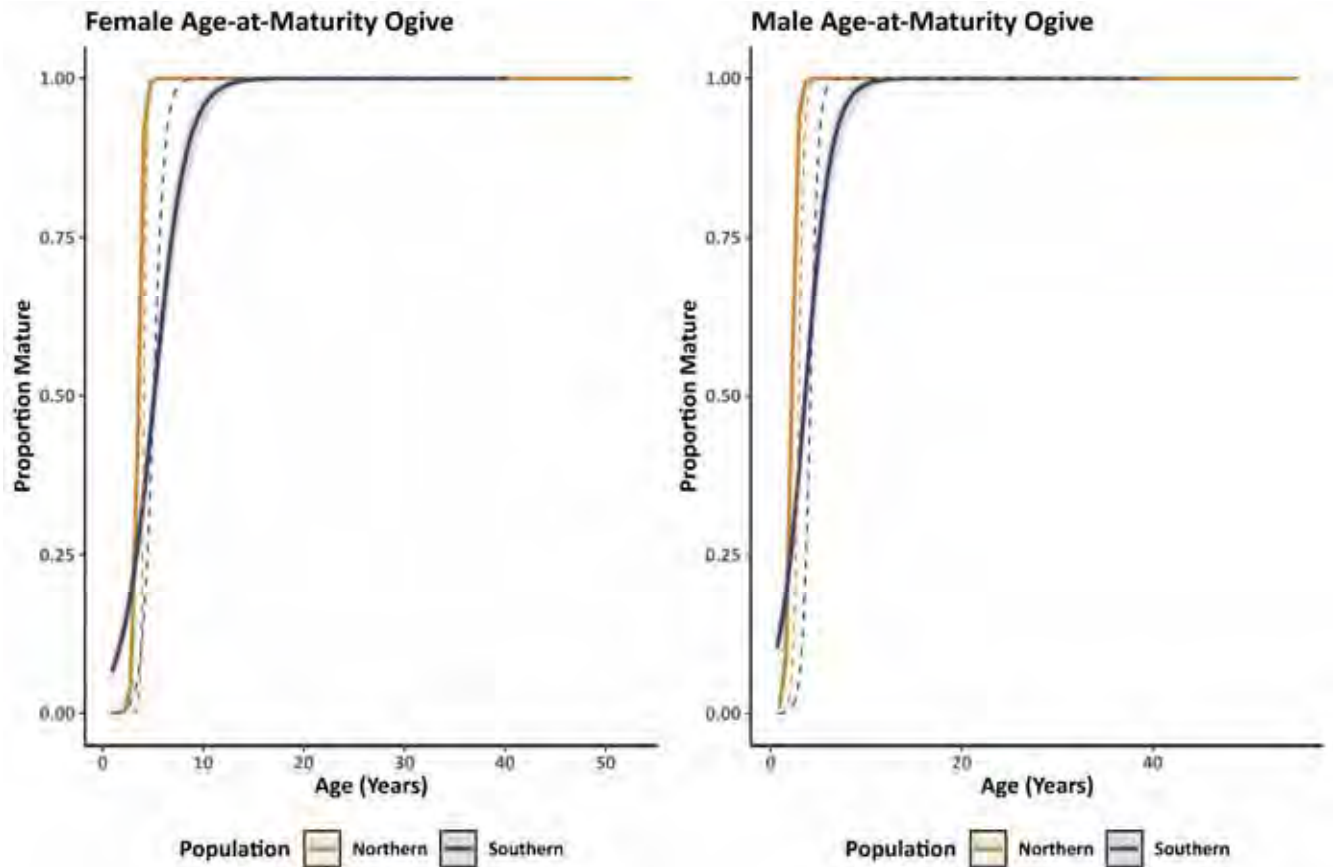


Figure 16. Best fit age-at-maturity ogives for female (left panel) and male (right panel) red drum from the southern (solid blue line) and northern (solid orange line) stocks. Shaded regions represent 95% confidence interval about the ogive. Dashed lines are the maturity ogives presented in SEDAR 44.

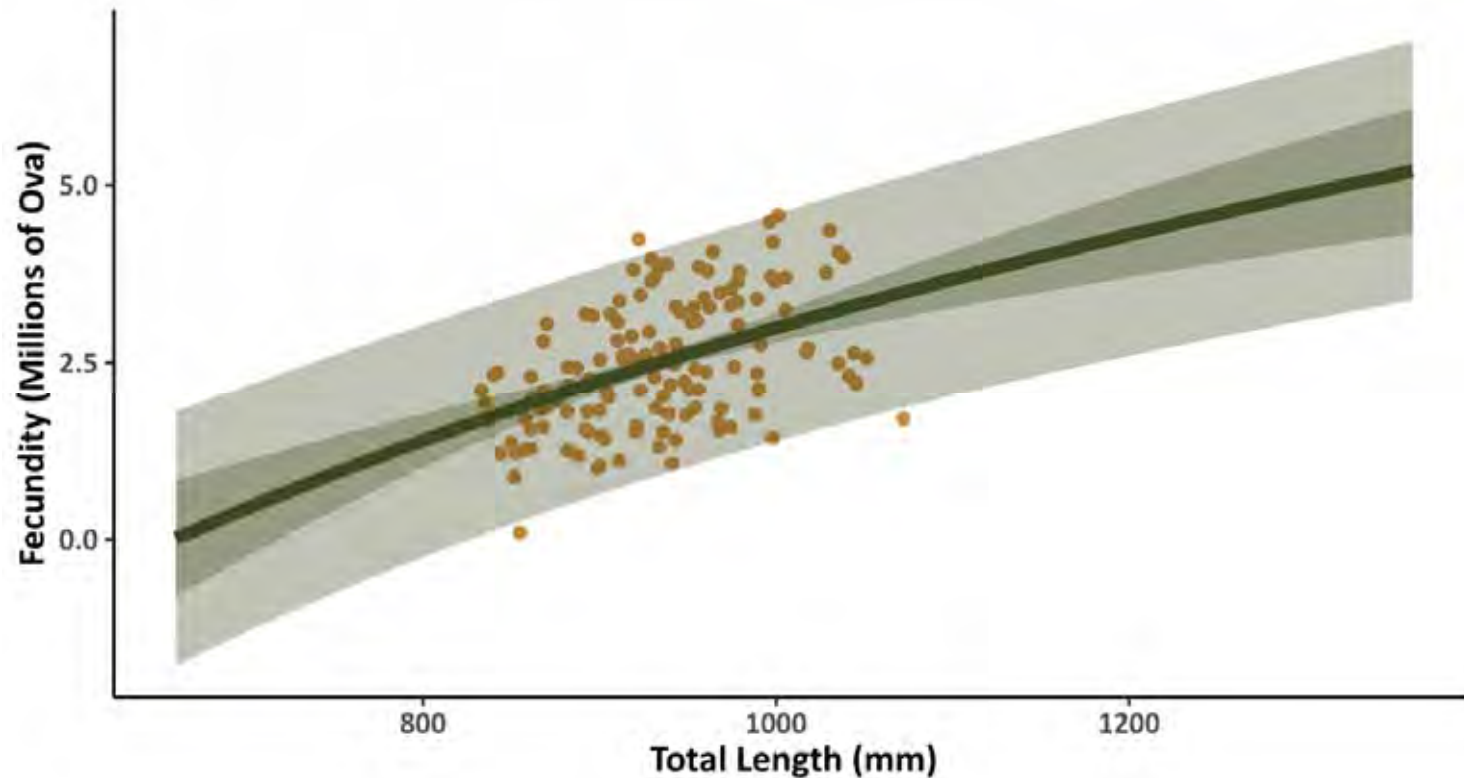
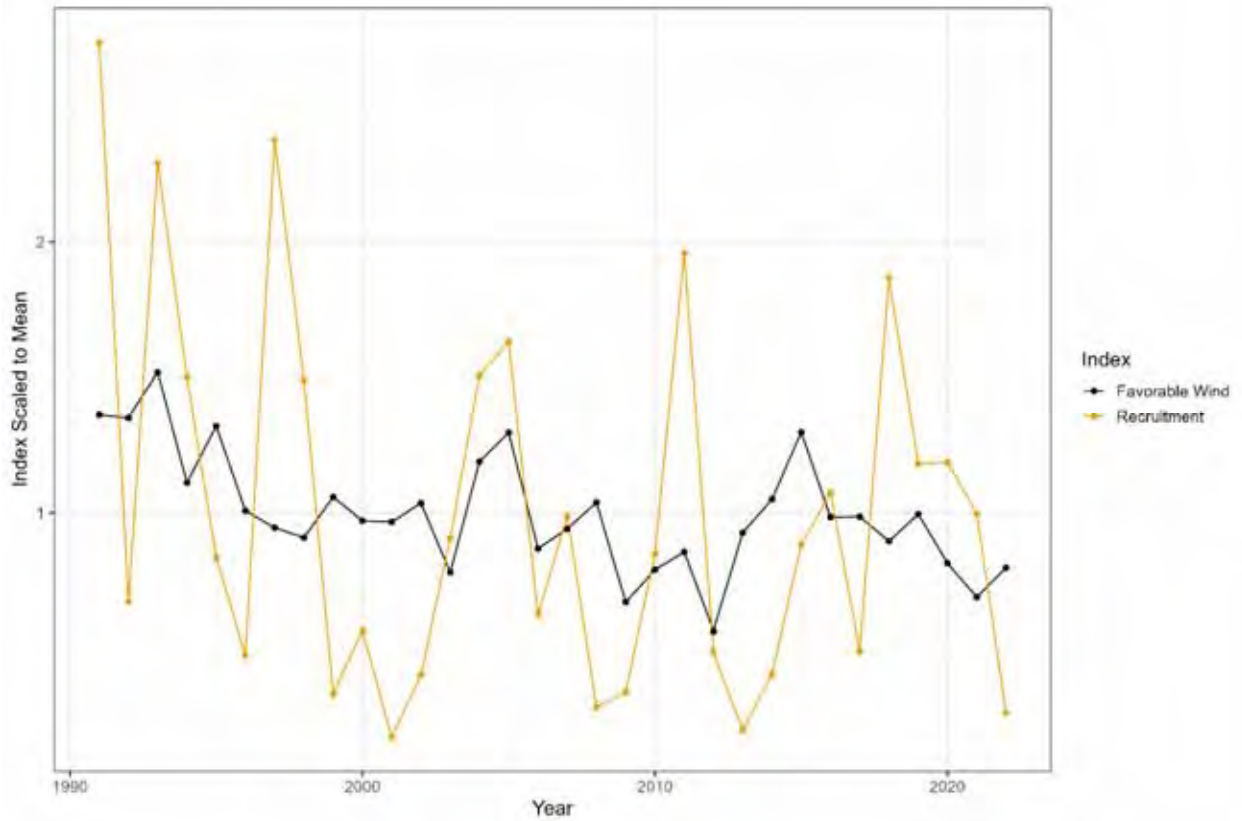
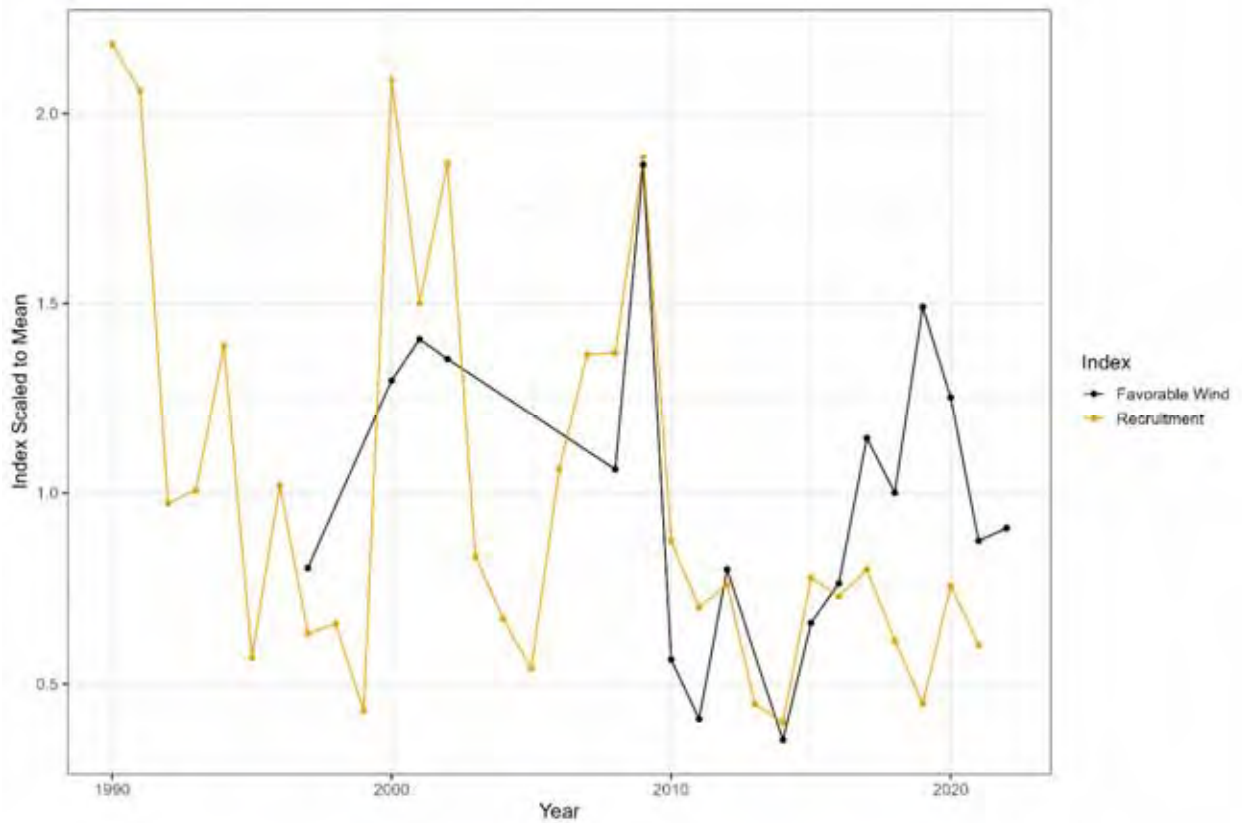


Figure 17. Batch fecundity estimates of female red drum based on the FWRI data set available from Tampa Bay, FL (orange dots) along with a fitted linear regression model (green line) and 95% confidence intervals (dark shaded region) and 95% prediction intervals (light shaded region) for the range of sizes with positive fecundity estimates (based on the model) and non-zero probability of a female being mature based on the Atlantic southern stock length-at-maturity ogive developed for this assessment.

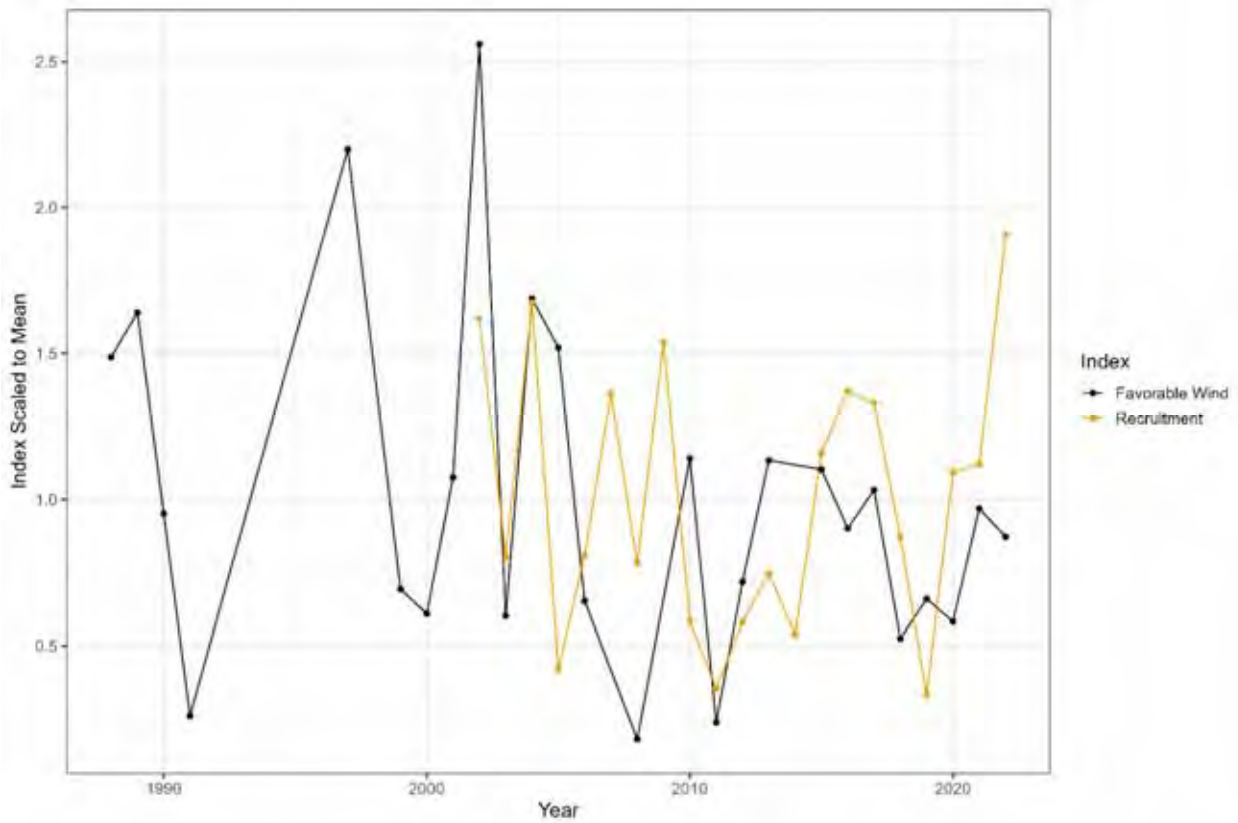




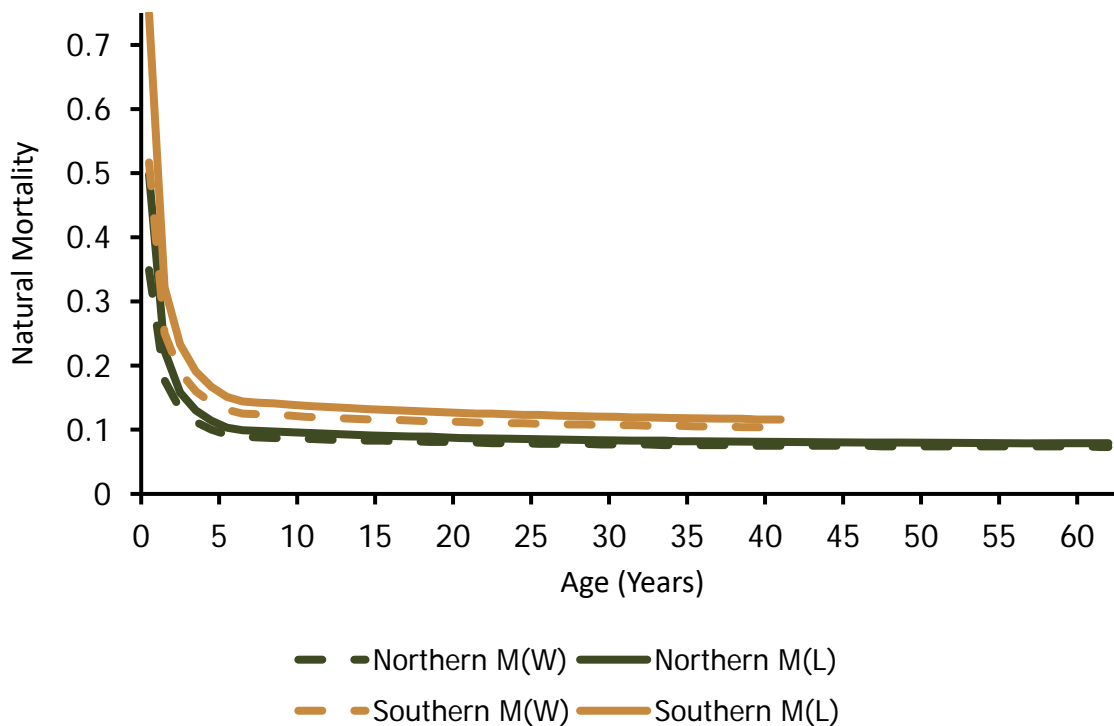
**Figure 18. North Carolina Bag Seine Survey recruitment index and seasonal favorable wind index from North Carolina State Climate Office station KHSE.**



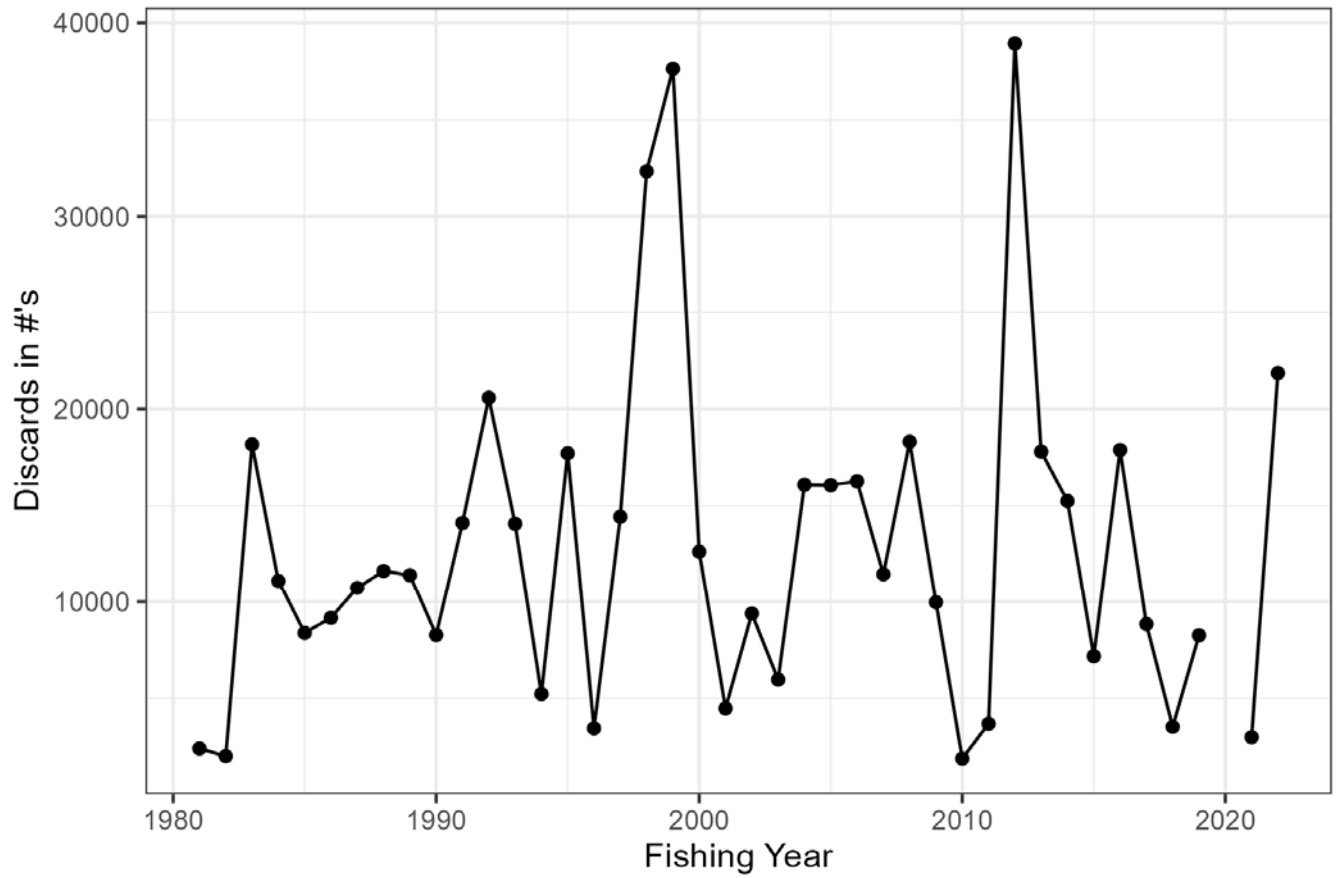
**Figure 19. South Carolina Trammel Net Survey age-1 index lagged back one year and early September favorable wind index from NOAA National Data Buoy Center Station 41004 southeast of Charleston.**



**Figure 20. Georgia Gill Net Survey age-0 fishing year index and early August favorable wind index from NOAA National Data Buoy Center Station 41008 southeast of Savannah.**



**Figure 21. Northern (green lines) and southern (gold lines) externally derived natural mortality estimates based on stock-specific maximum age and either weight-based M-at-age (dashed lines; Lorenzen 1996) or length-based M-at-age (solid lines; Lorenzen 2022).**



**Figure 22. Estimated red drum discards in numbers based on North Carolina estuarine gill net observer program.**



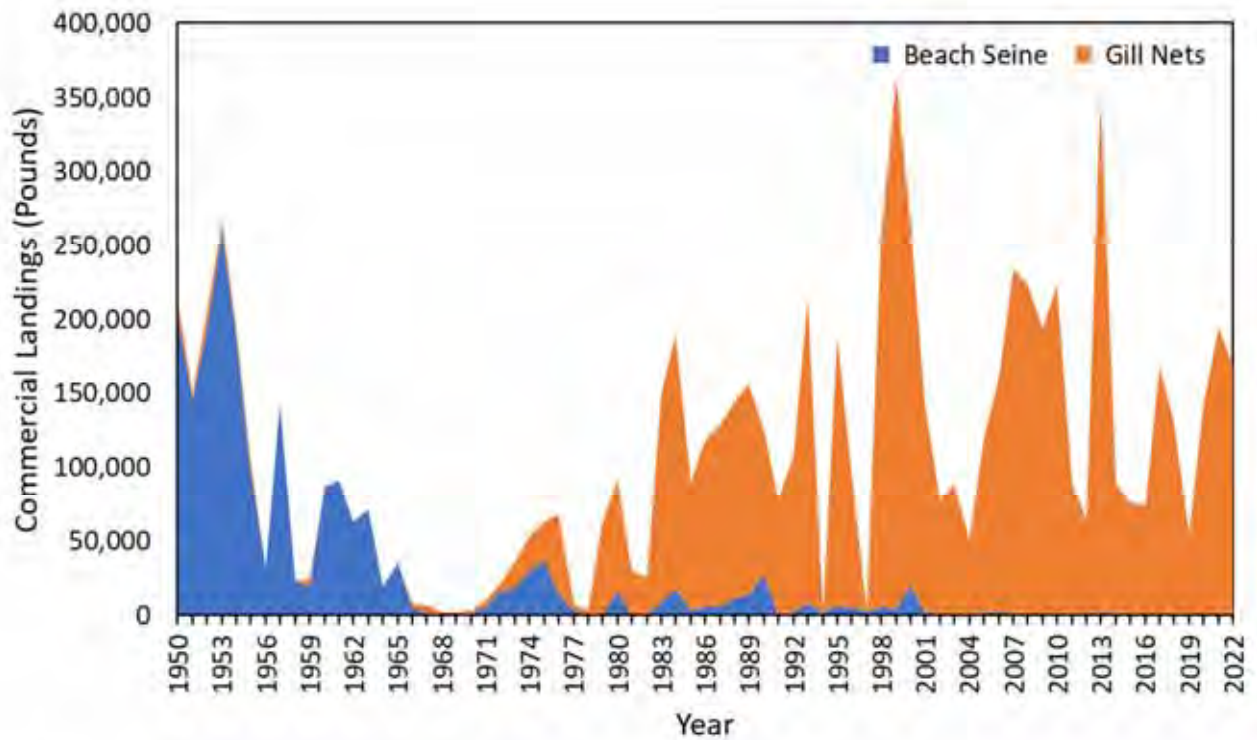


Figure 23. Total commercial landings of northern stock red drum by the commercial gill net and beach seine (GNBS) fleet. Confidential data have been removed from the data set.

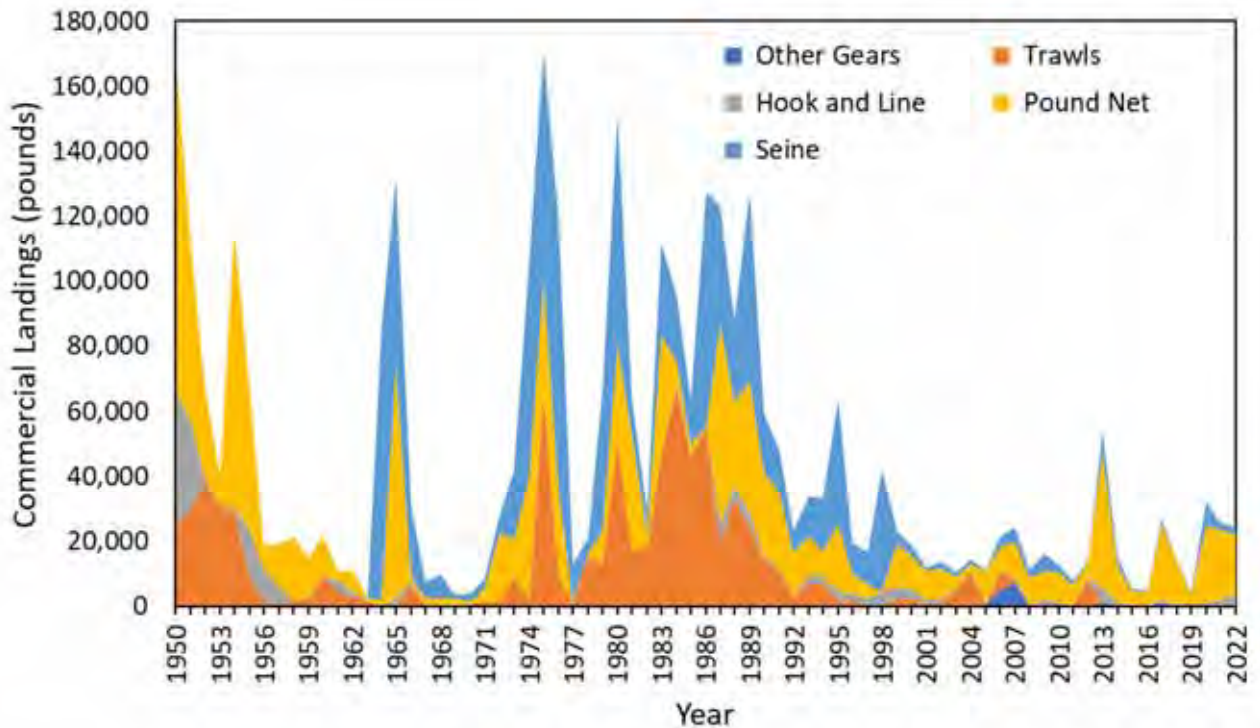


Figure 24. Total commercial landings of northern stock red drum by the commercial other gear fleet. Confidential data have been removed from the data set.

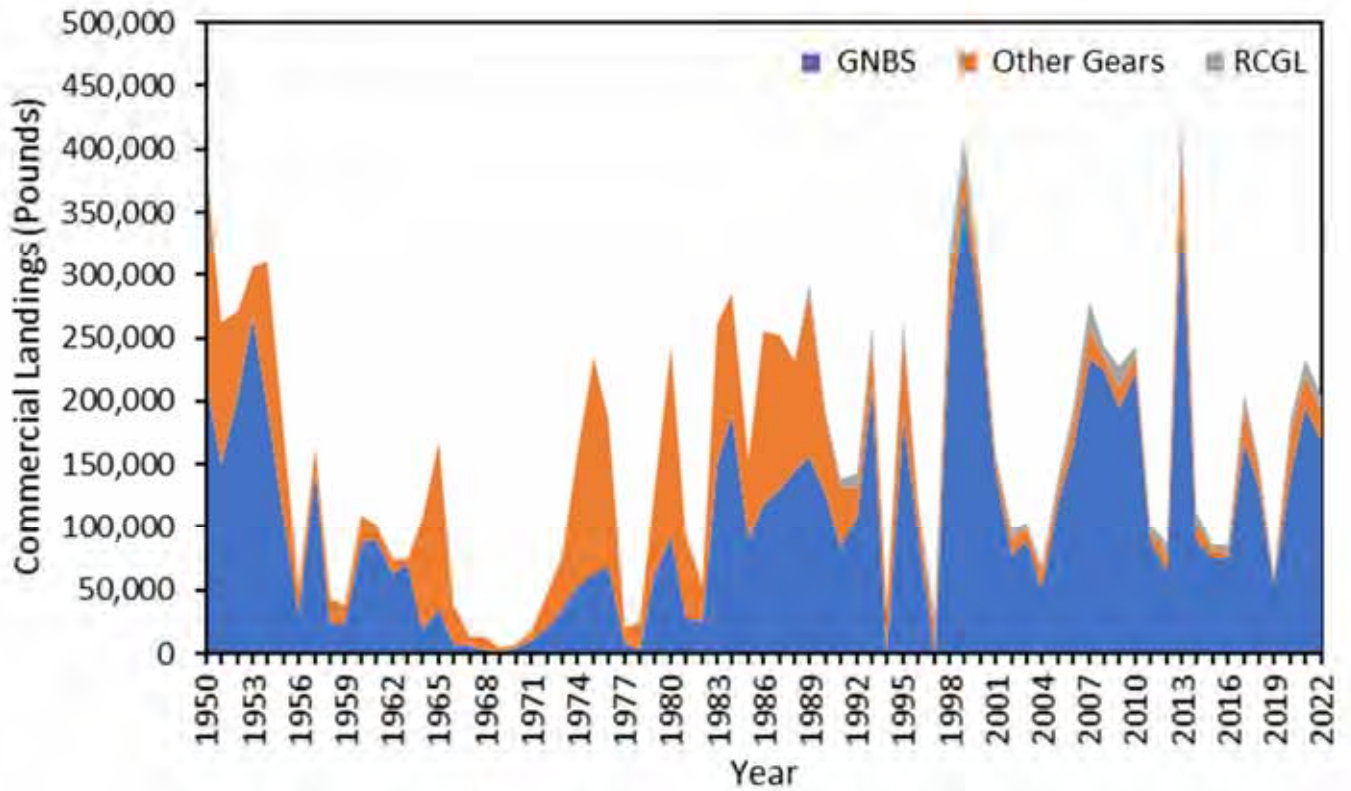


Figure 25. Total commercial landings of northern stock red drum. Confidential data have been removed from the data set.

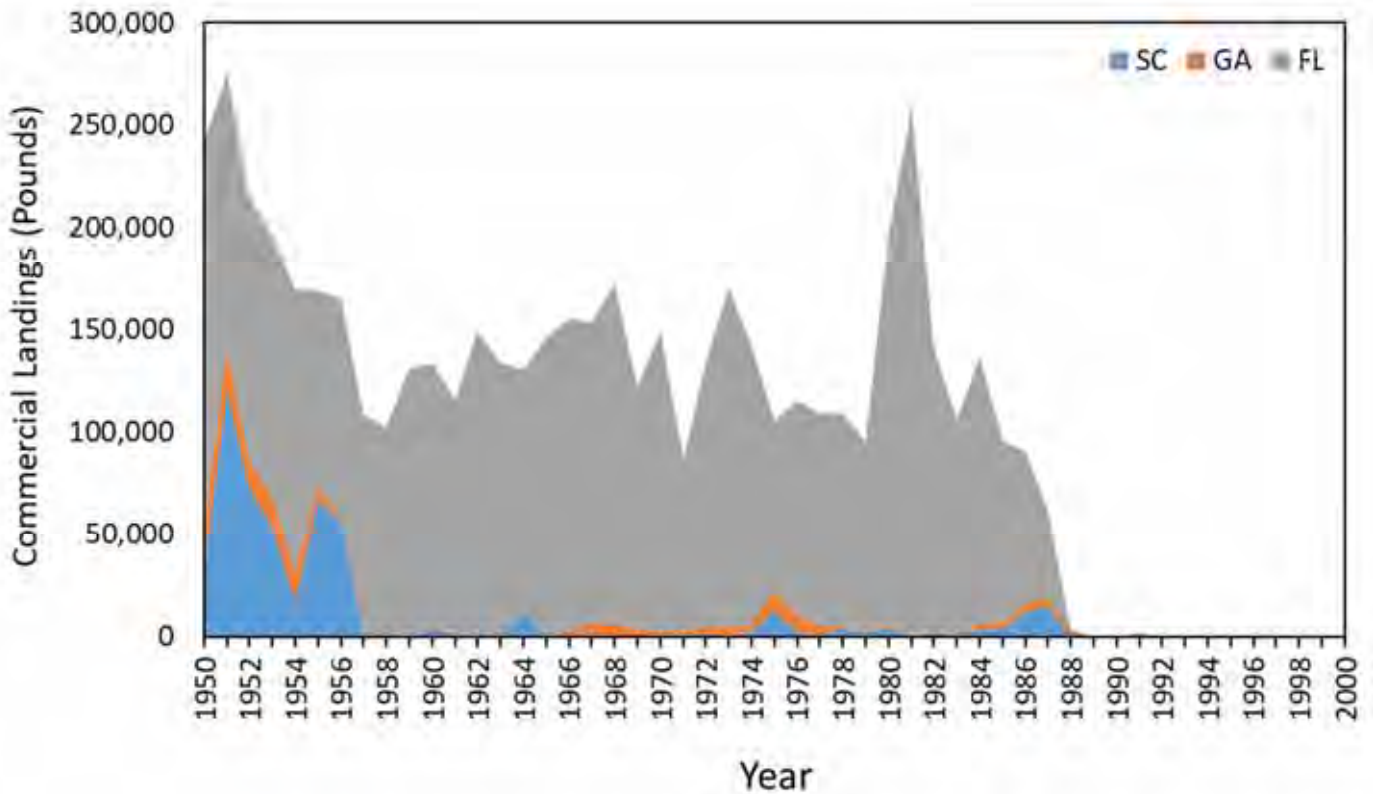
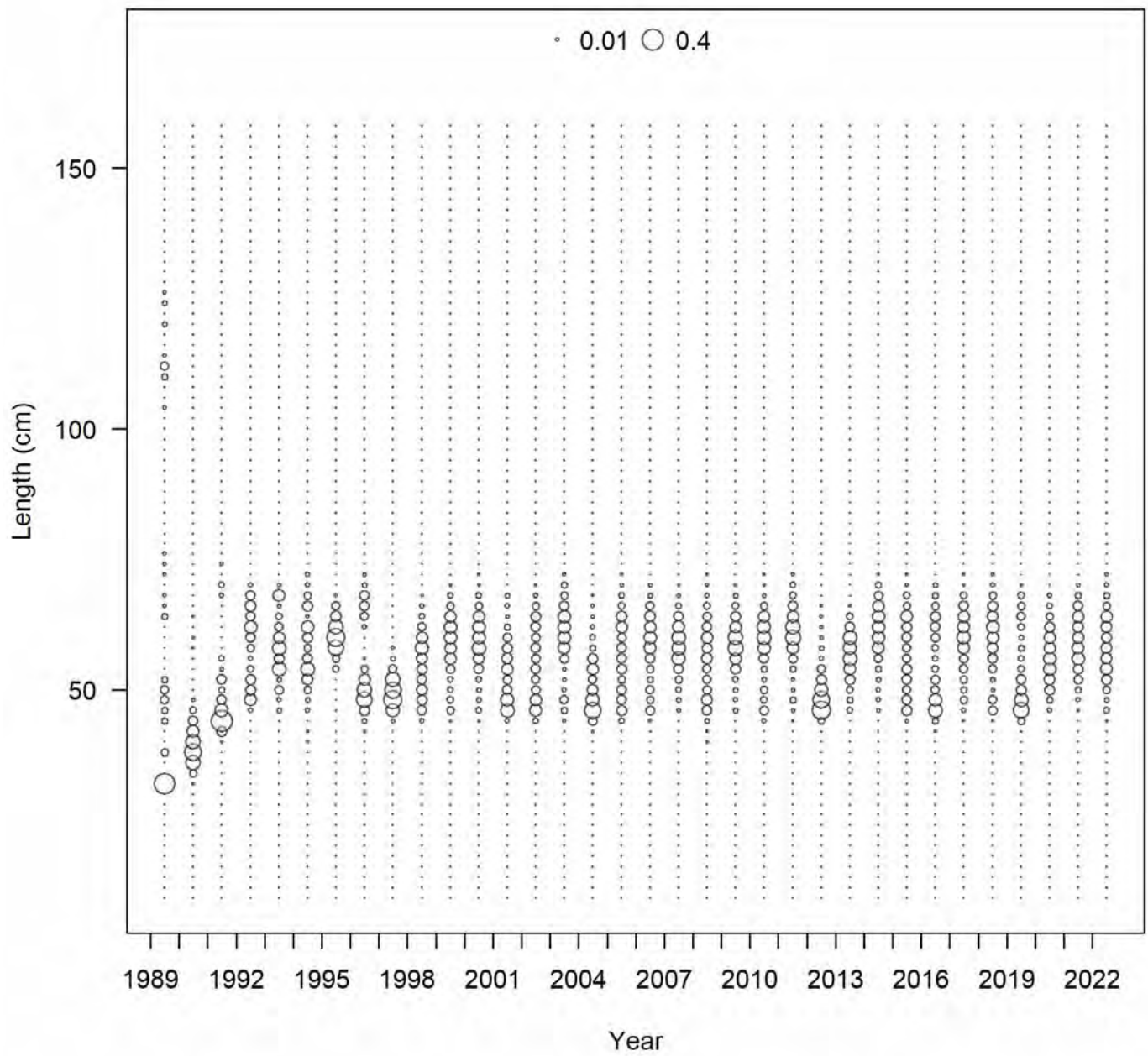
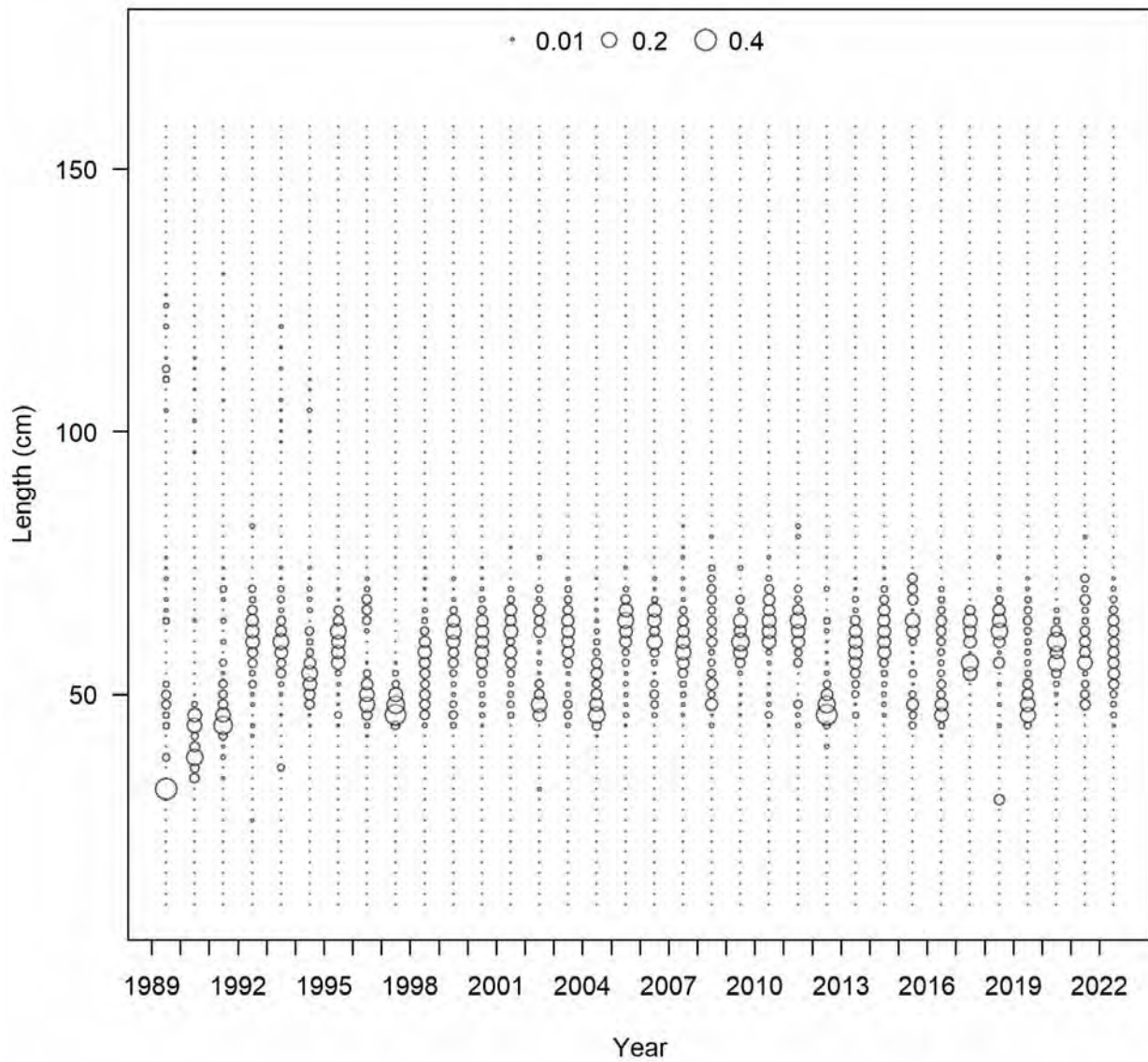


Figure 26. Total commercial landings of southern stock red drum. Confidential data have been removed from the data set.



**Figure 27. Annual length distributions of red drum landed by the North\_Commercial\_GNBS fleet.**





**Figure 28. Annual length distributions of red drum landed by the North\_Commercial\_Other fleet.**

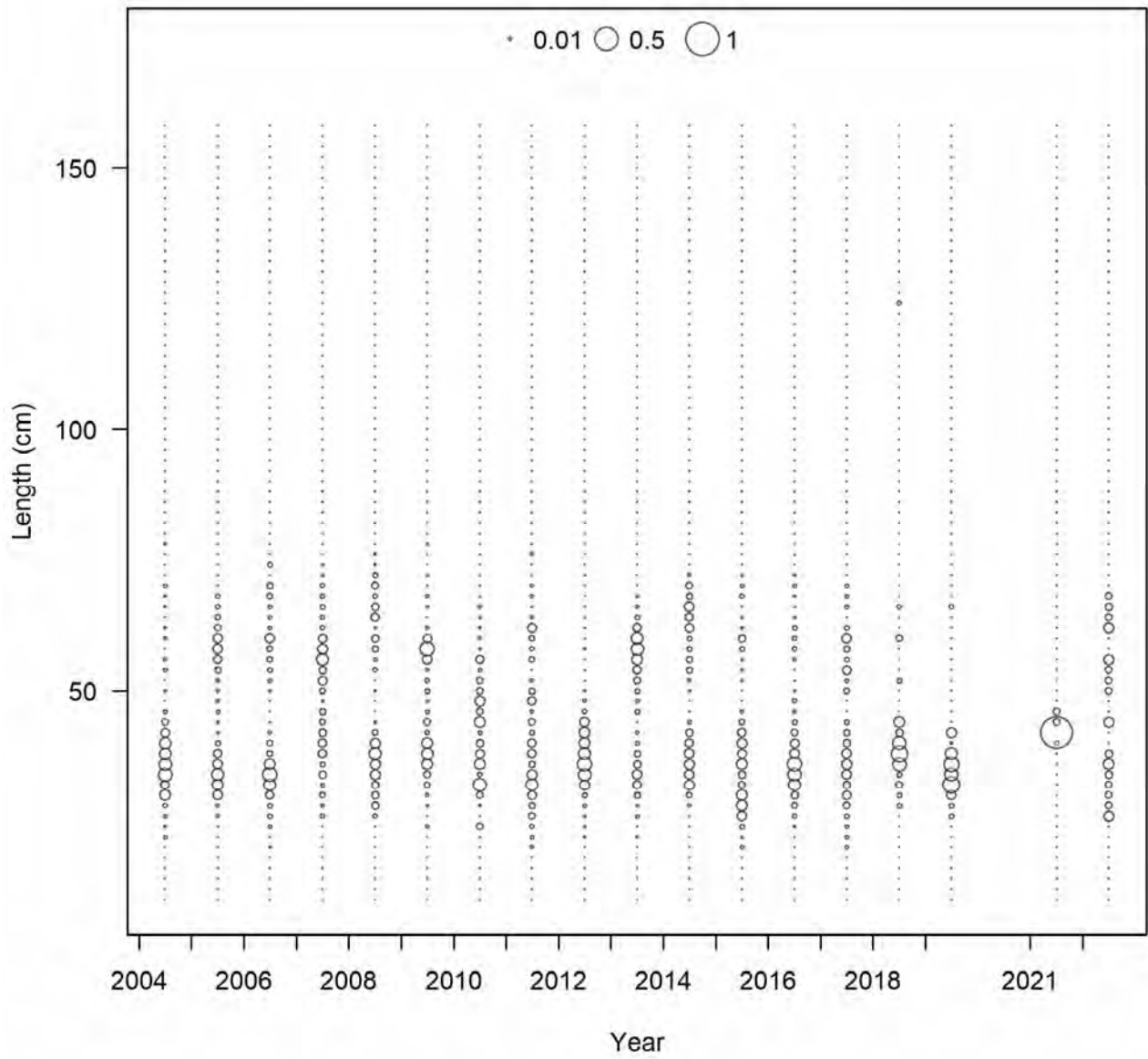
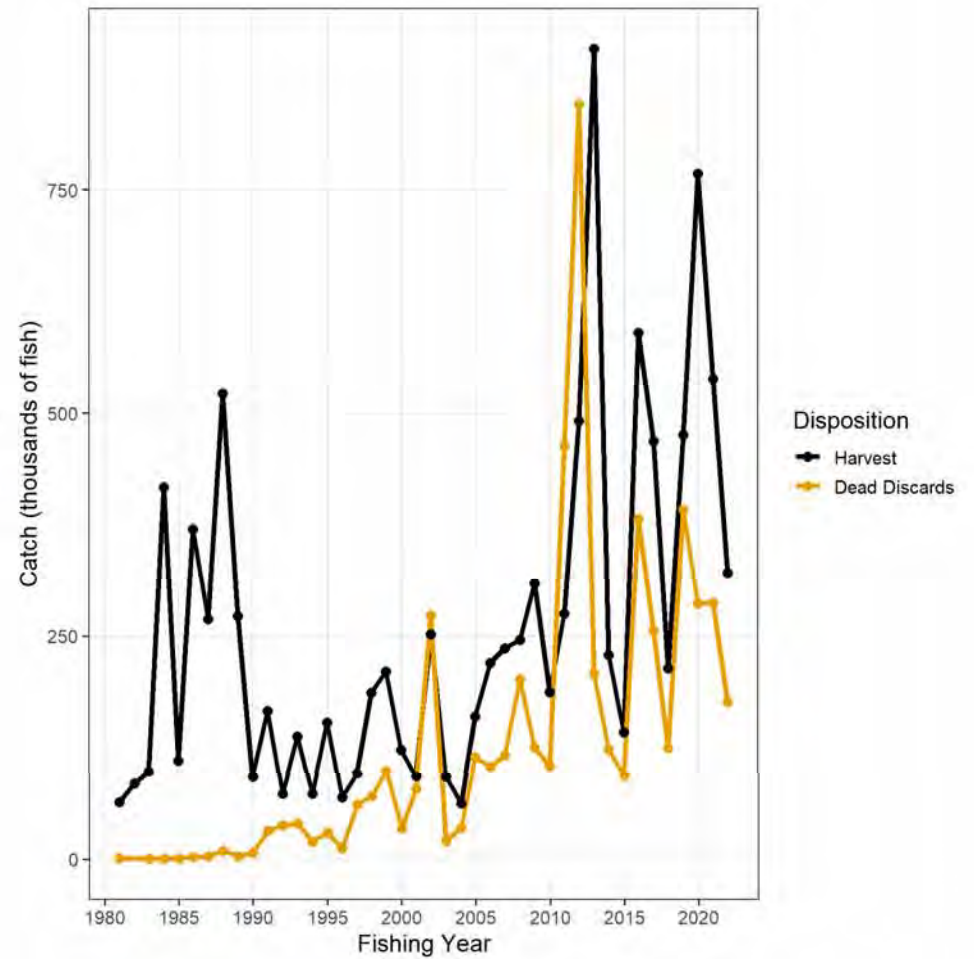
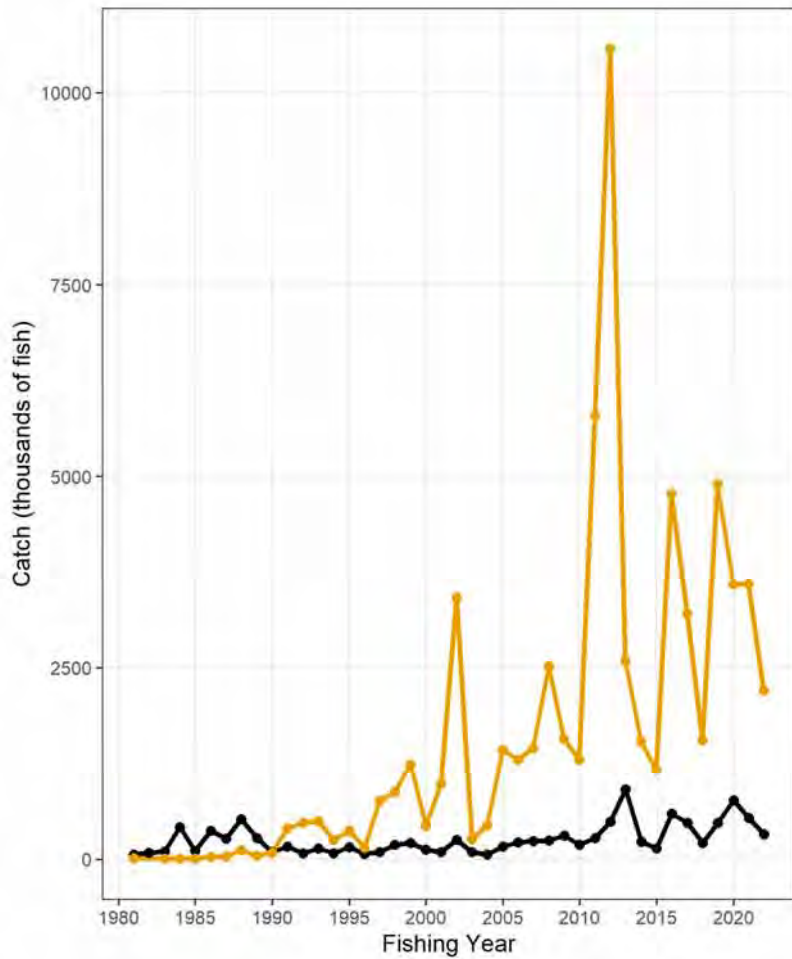


Figure 29. Annual length distributions of red drum discarded by the North Commercial GNBS fleet.



**Figure 30. MRIP recreational catch estimates of red drum from the northern stock. Dead discards are calculated with an assumed 8% discard mortality of releases. \*\*2022 data are preliminary.**

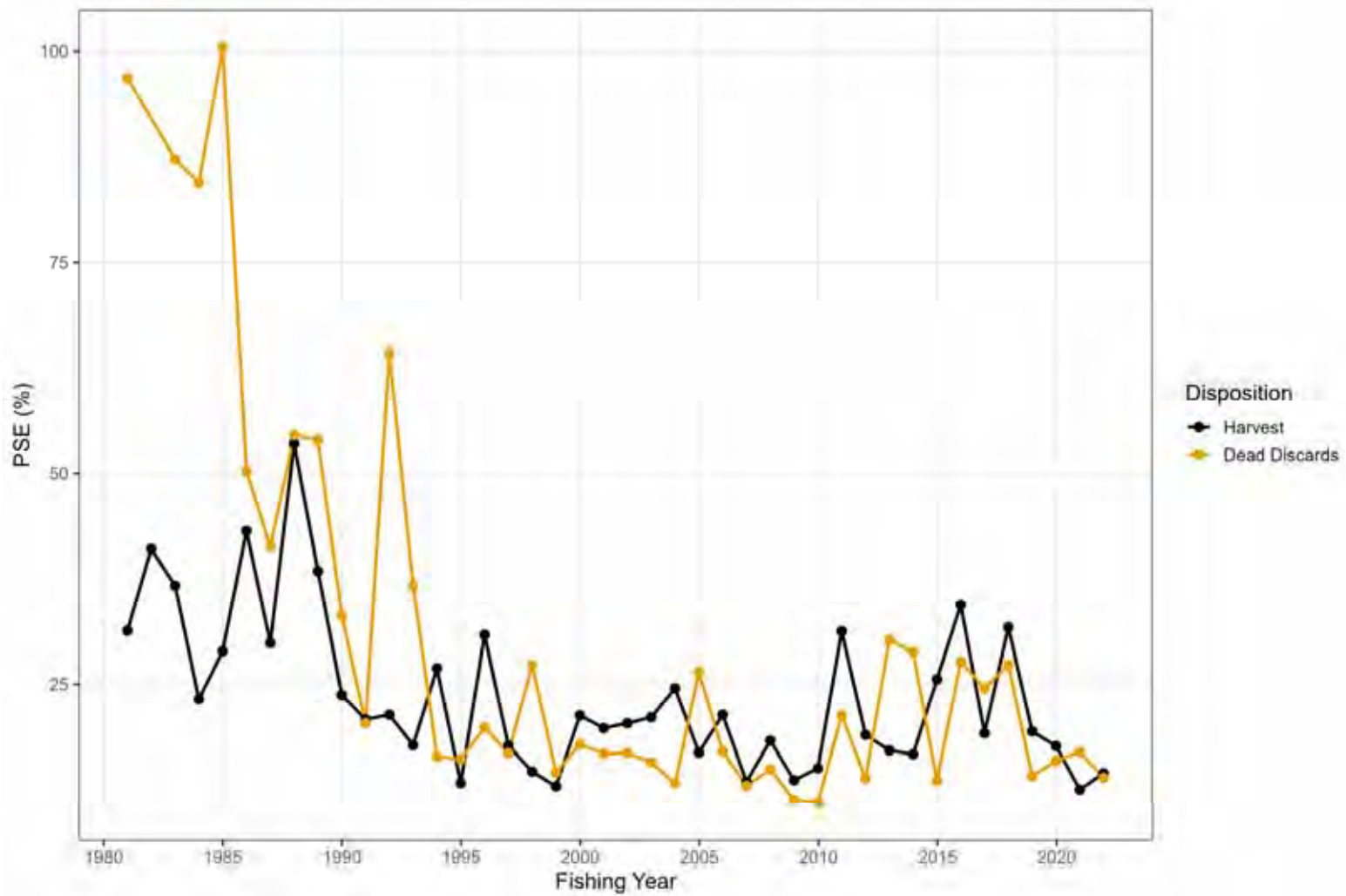
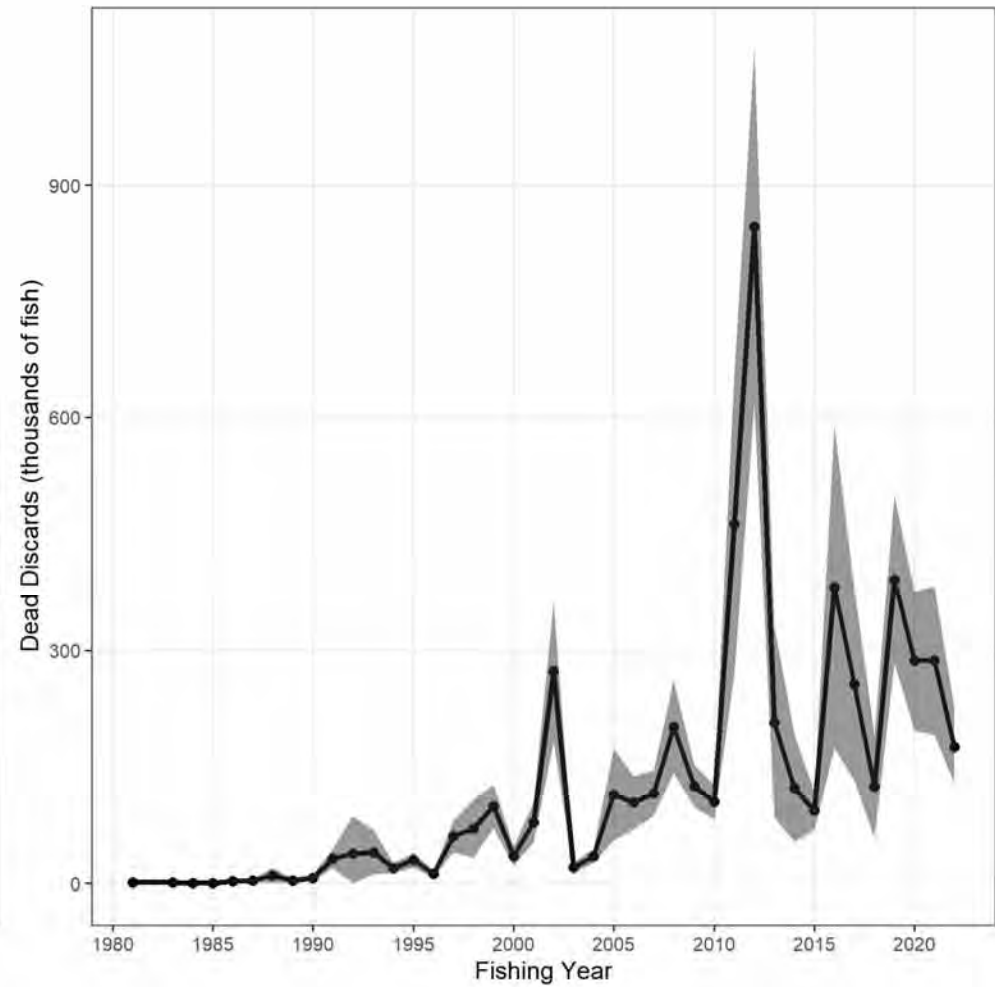
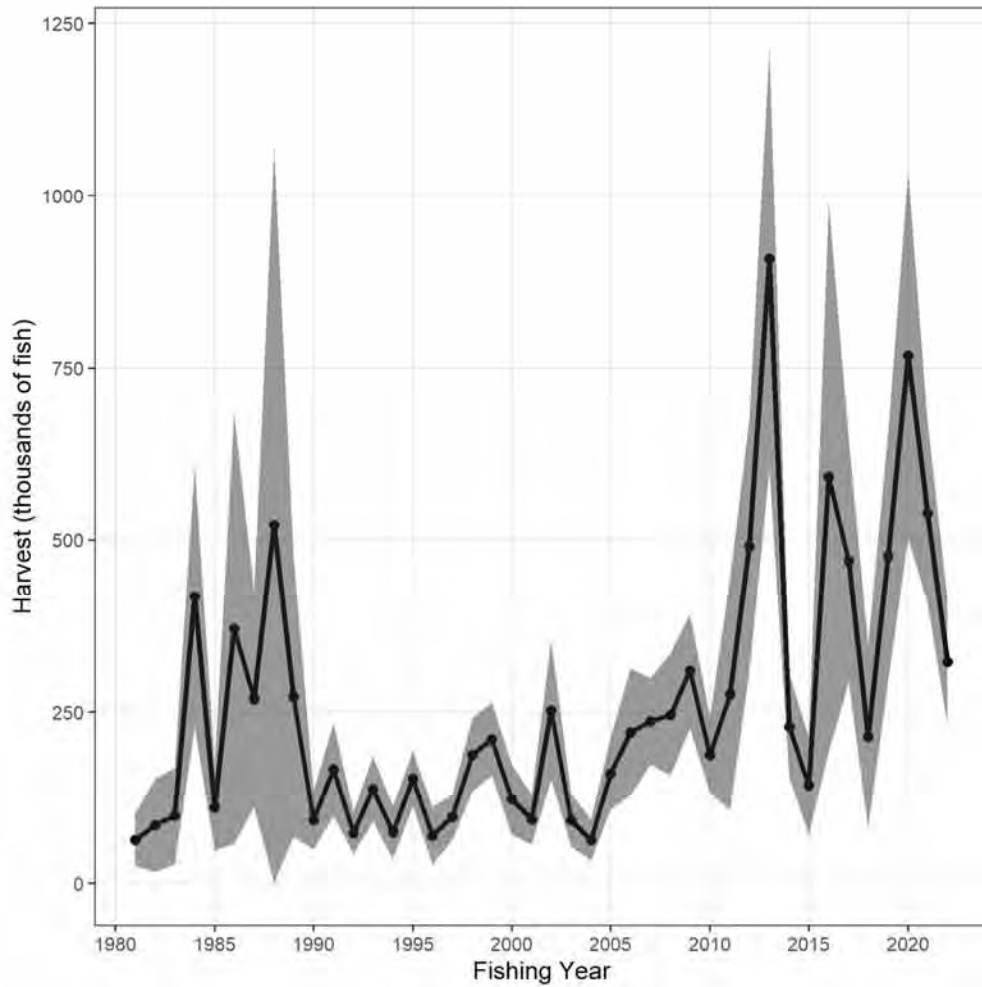


Figure 31. Proportional standard error of MRIP recreational catch estimates of red drum from the northern stock. \*\*2022 data are preliminary.



**Figure 32. MRIP recreational catch estimates of red drum from the northern stock with 95% confidence intervals (shaded regions). Dead discards are calculated with an assumed 8% discard mortality of releases and confidence intervals are calculated assuming the same PSEs as for released alive estimates. \*\*2022 data are preliminary.**



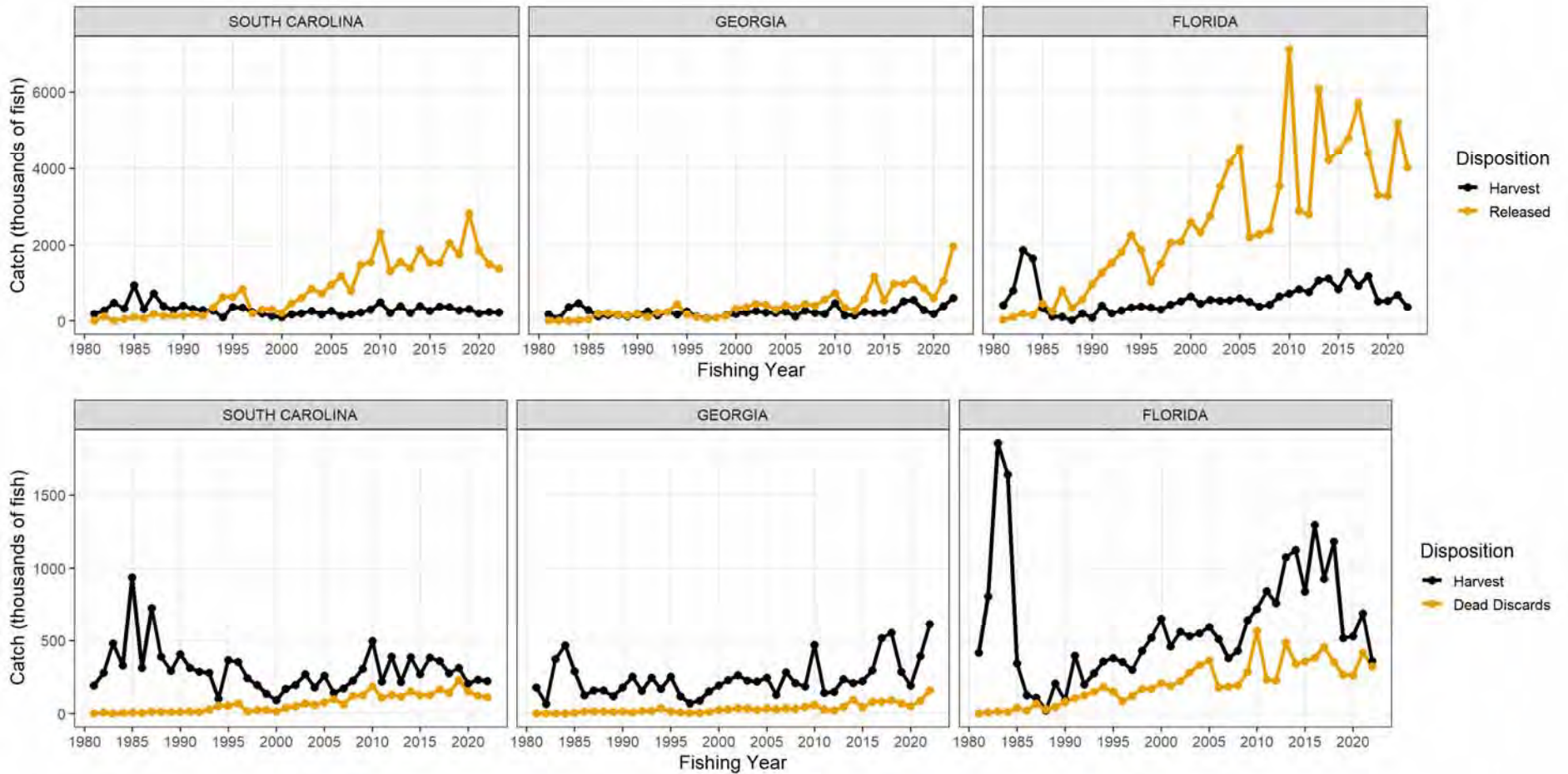
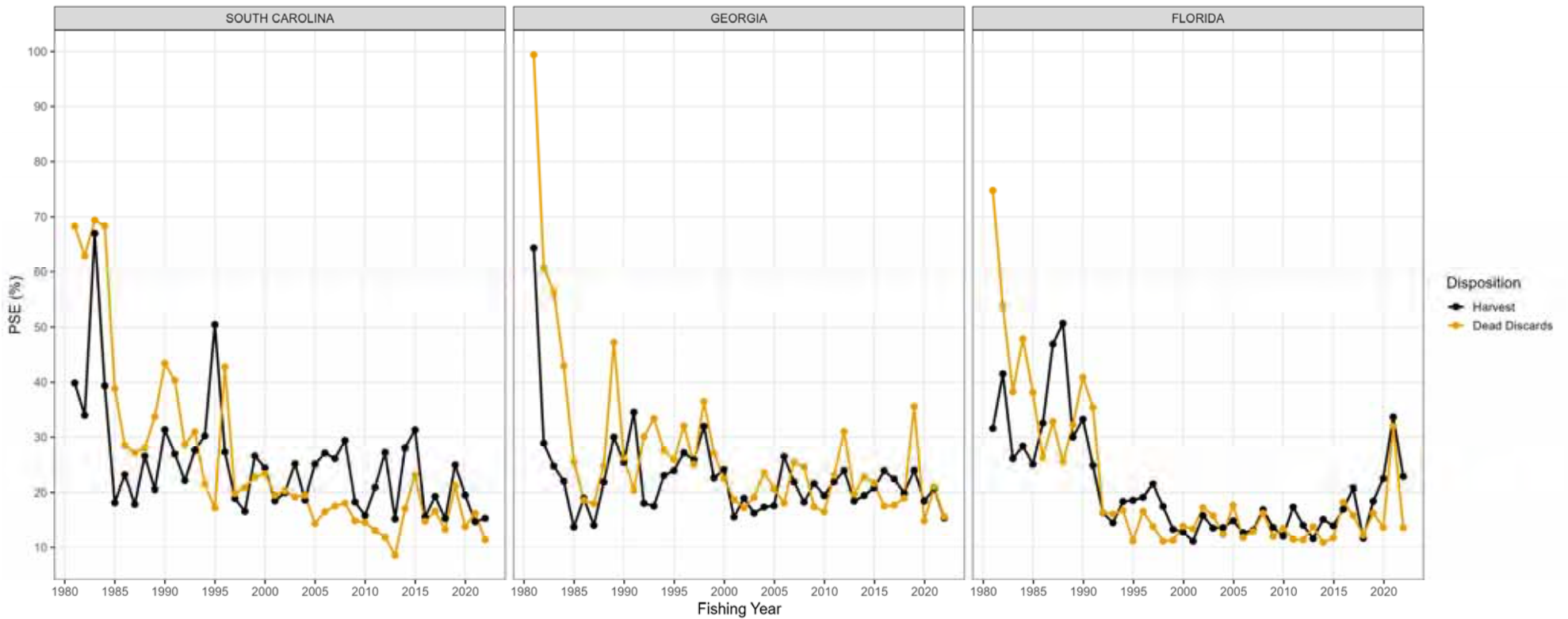
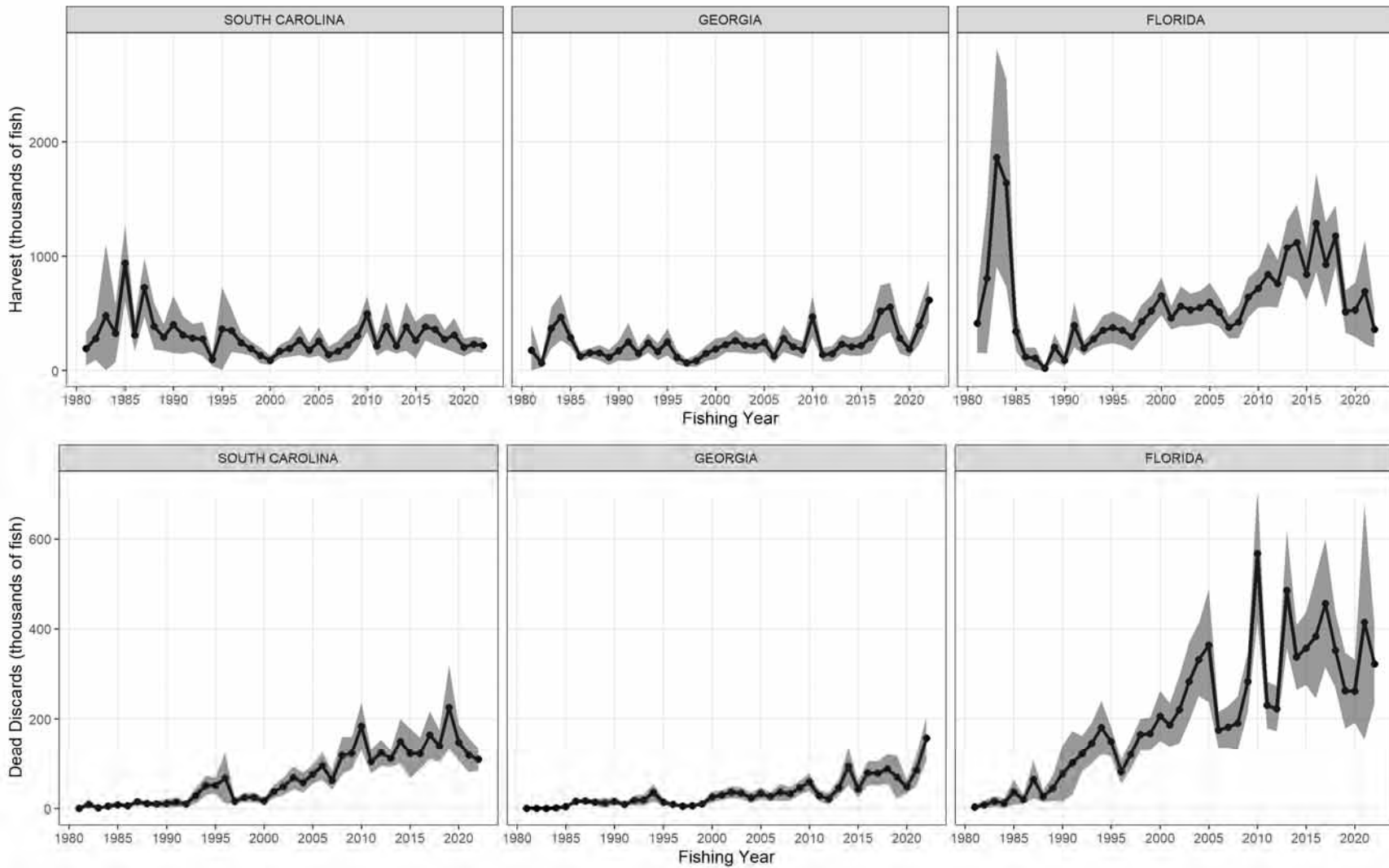


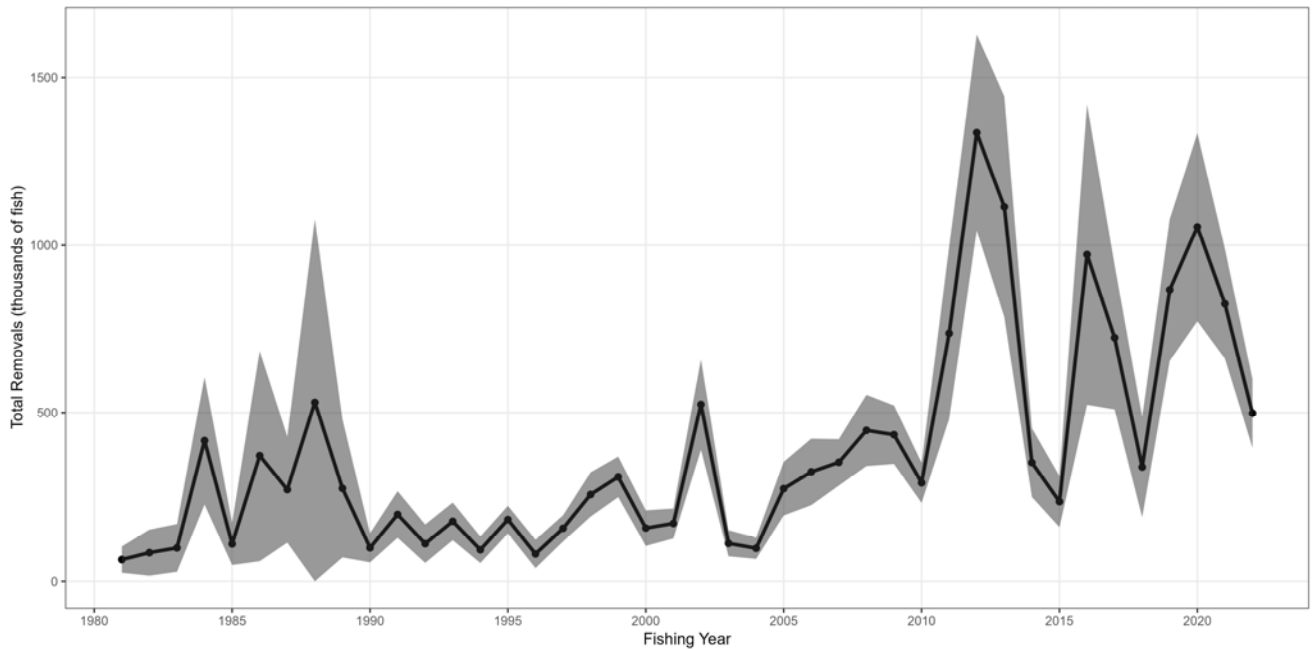
Figure 33. MRIP recreational catch estimates of red drum from the southern stock. Dead discards are calculated with an assumed 8% discard mortality of releases. \*\*2022 data are preliminary.



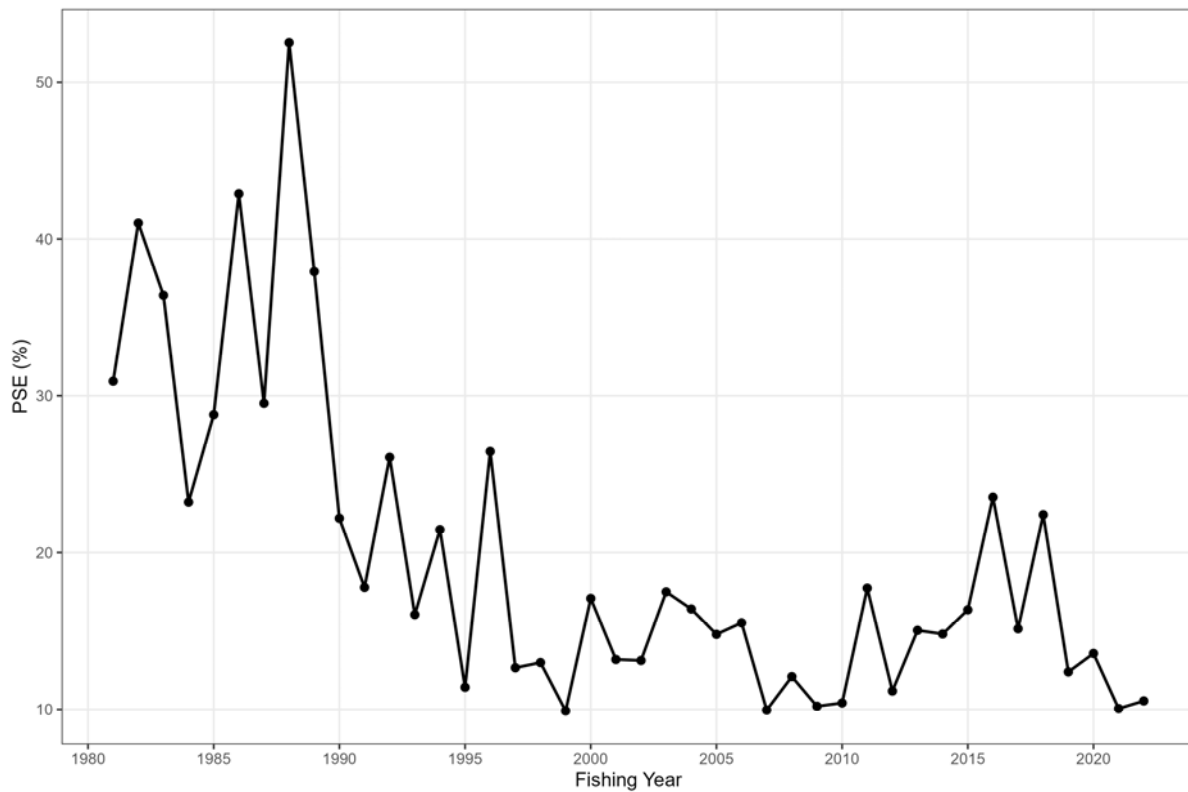
**Figure 34. Proportional standard error of MRIP recreational catch estimates of red drum from the southern stock. \*\*2022 data are preliminary.**



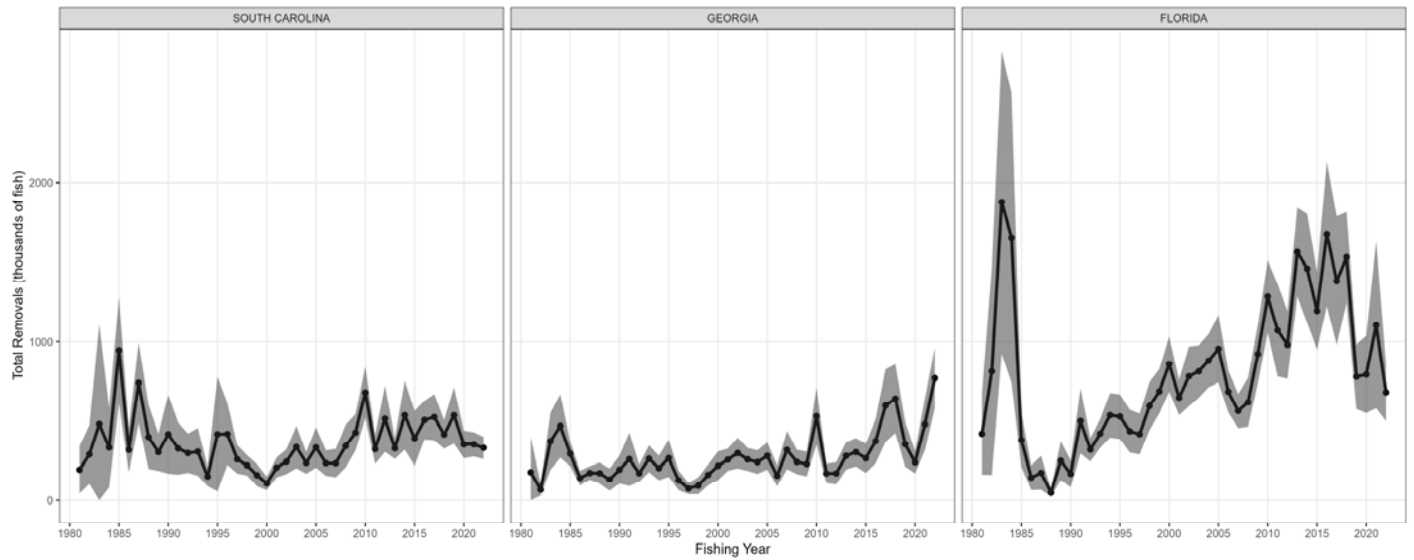
**Figure 35. MRIP recreational catch estimates of red drum from southern stock states with 95% confidence intervals (shaded regions). Dead discards are calculated with an assumed 8% discard mortality of releases and confidence intervals are calculated assuming the same PSEs as for released alive estimates. \*\*2022 data are preliminary.**



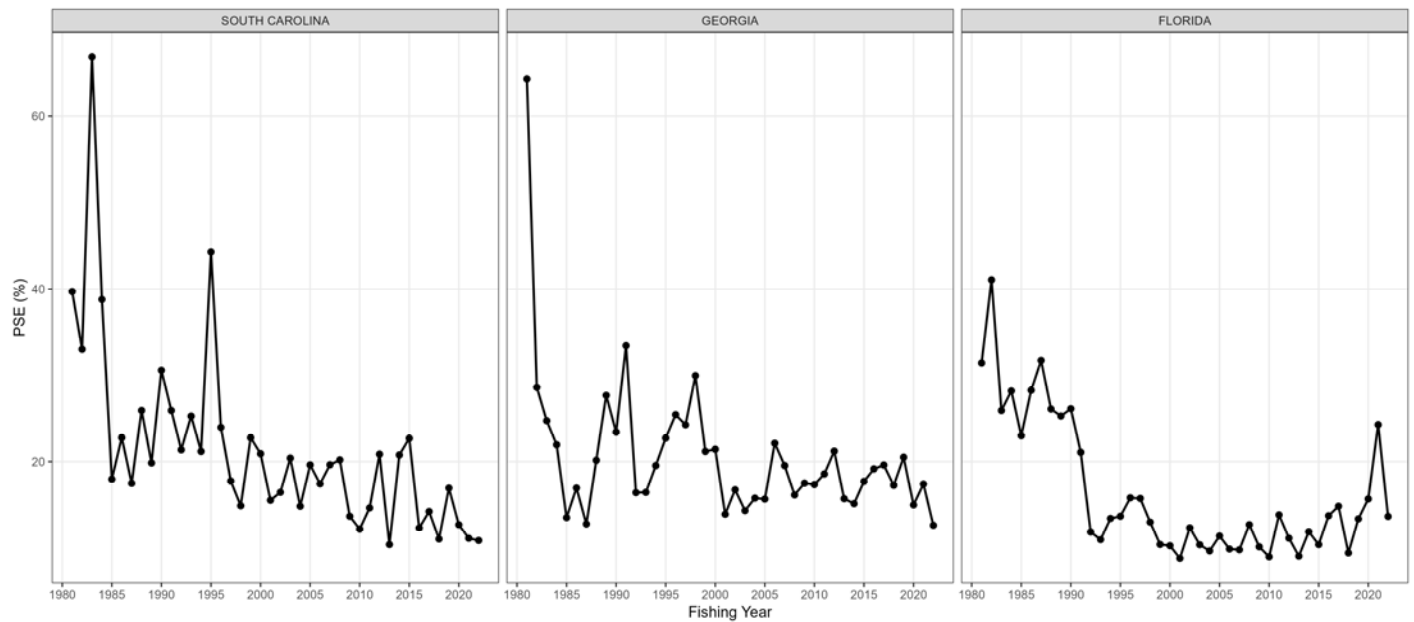
**Figure 36. MRIP recreational total removal estimates of red drum from the northern stock with 95% confidence intervals (shaded regions). Dead discards are calculated with an assumed 8% discard mortality of releases and confidence intervals are calculated assuming the same PSEs as for released alive estimates. \*\*2022 data are preliminary.**



**Figure 37. Proportional standard error of MRIP recreational total removal estimates of red drum from the northern stock (assuming released alive and dead discard PSEs are equal). \*\*2022 data are preliminary.**



**Figure 38. MRIP recreational total removal estimates of red drum from the southern stock with 95% confidence intervals (shaded regions). Dead discards are calculated with an assumed 8% discard mortality of releases and confidence intervals are calculated assuming the same PSEs as for released alive estimates. \*\*2022 data are preliminary.**



**Figure 39. Proportional standard error of MRIP recreational total removal estimates of red drum from the southern stock (assuming released alive and dead discard PSEs are equal). \*\*2022 data are preliminary.**

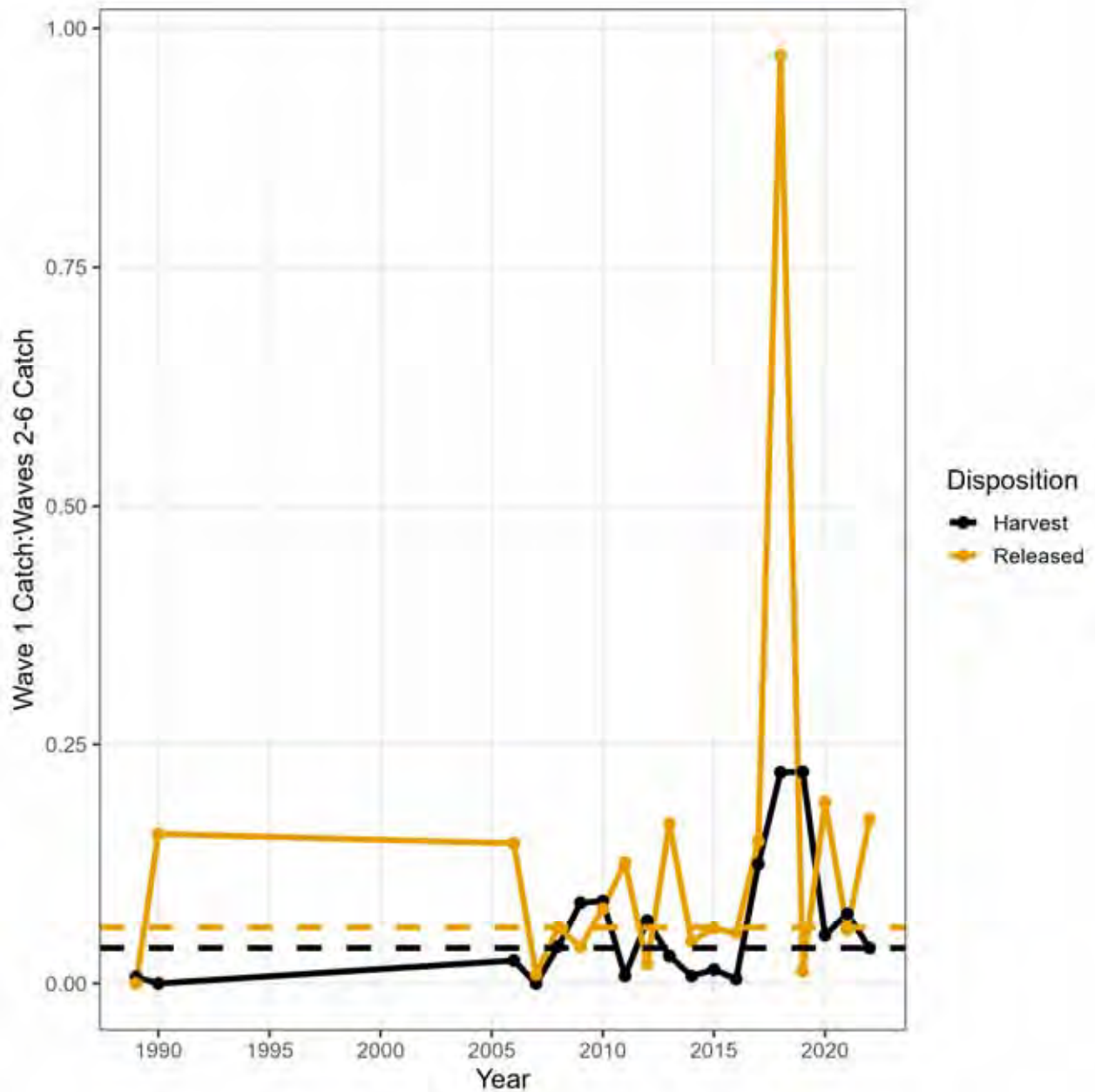


Figure 40. Ratios of wave 1 to waves 2-6 MRIP catch estimates from North Carolina for years when wave 1 catch estimates are available. Dashed horizontal lines show medians of annual ratios.

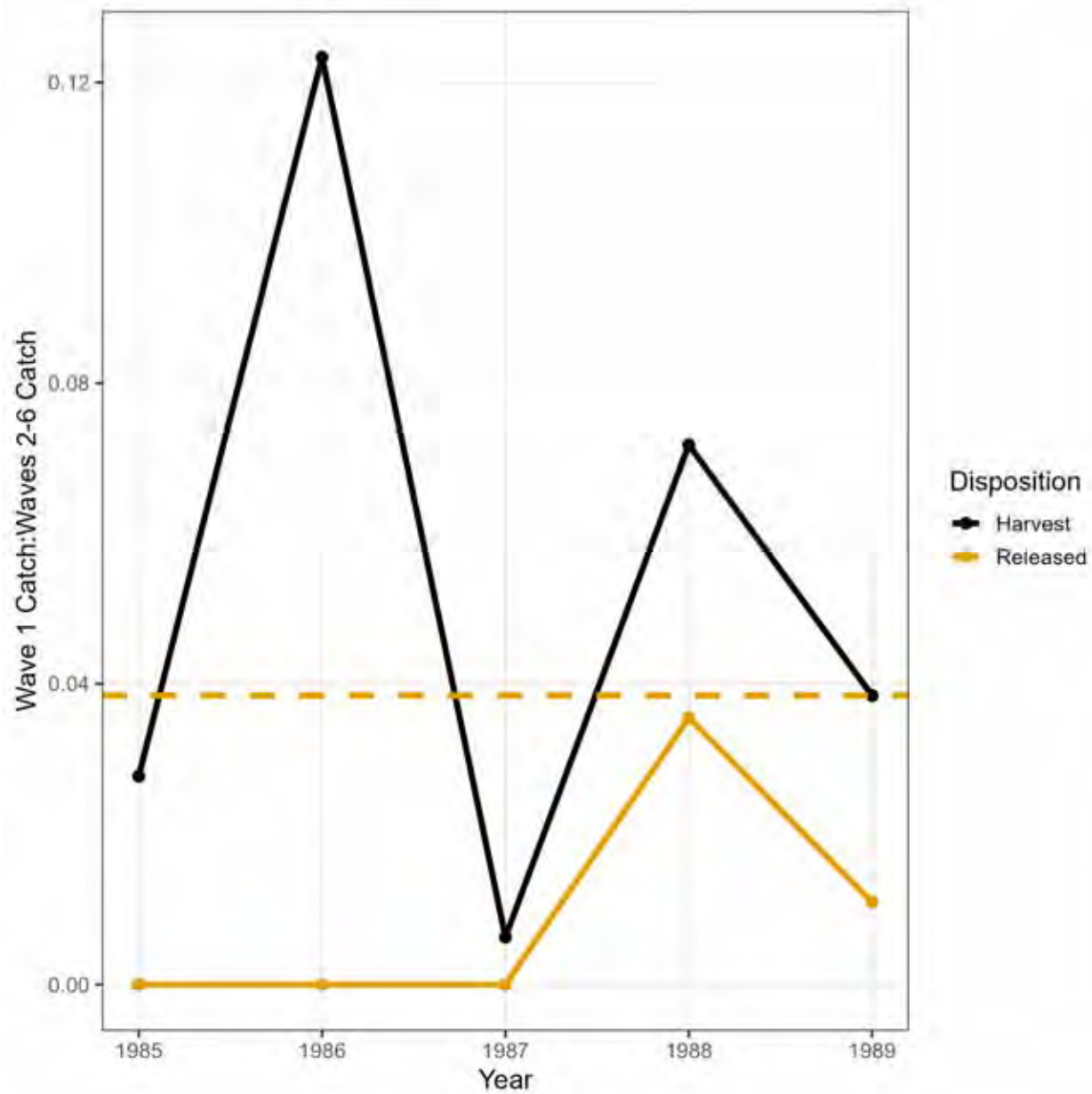


Figure 41. Ratios of wave 1 to waves 2-6 MRIP catch estimates from Georgia for years when wave 1 catch estimates are available. Dashed horizontal lines show medians of annual ratios. Due to a median of zero for released alive estimates, the harvest ratio ( $\approx 0.04$ ) was used for the released alive estimates and overlaps in this figure.

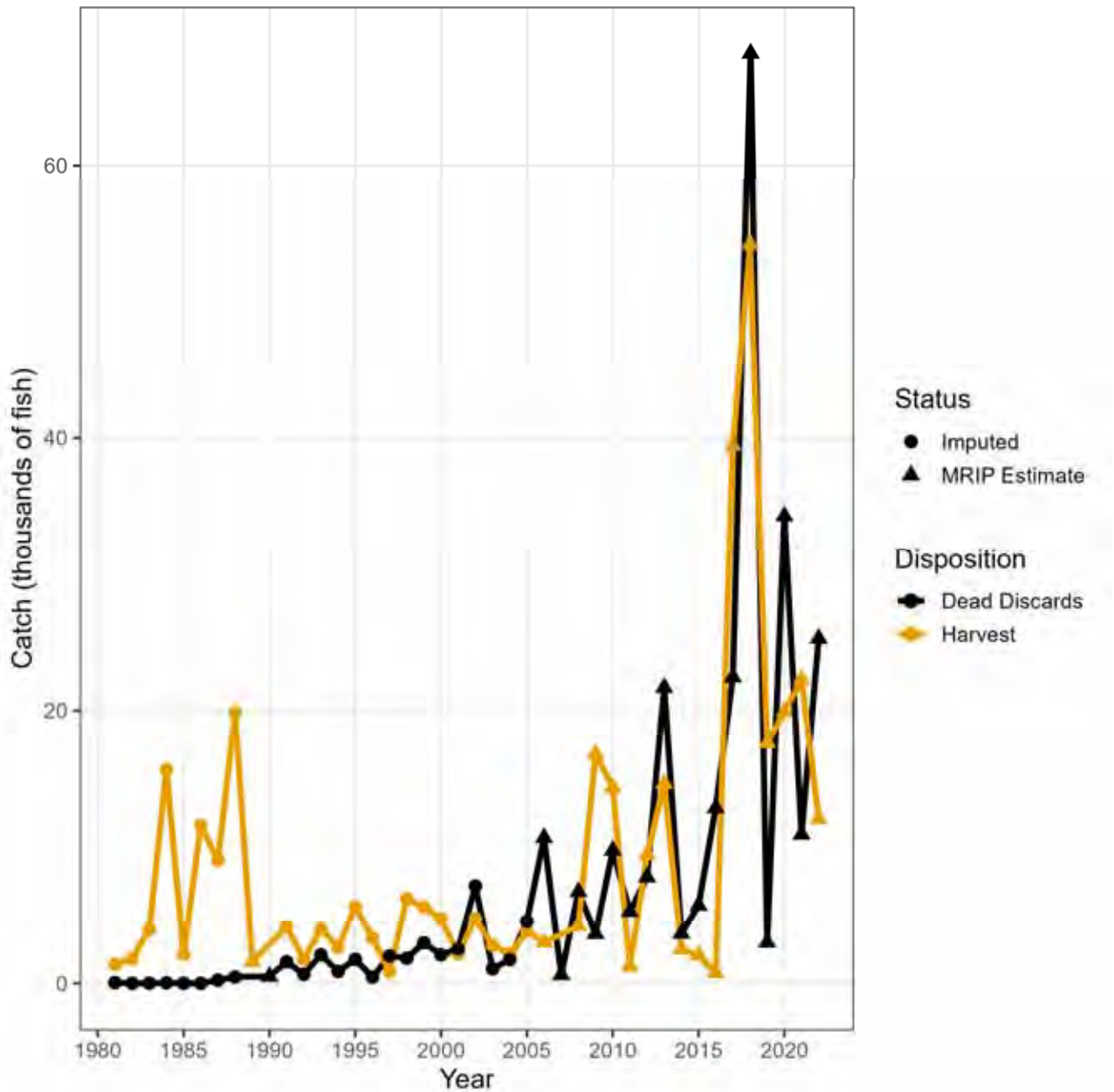


Figure 42. Wave 1 recreational catch estimates of red drum from North Carolina provided by MRIP and imputed with ratios of wave 1 to waves 2-6 MRIP catch estimates.



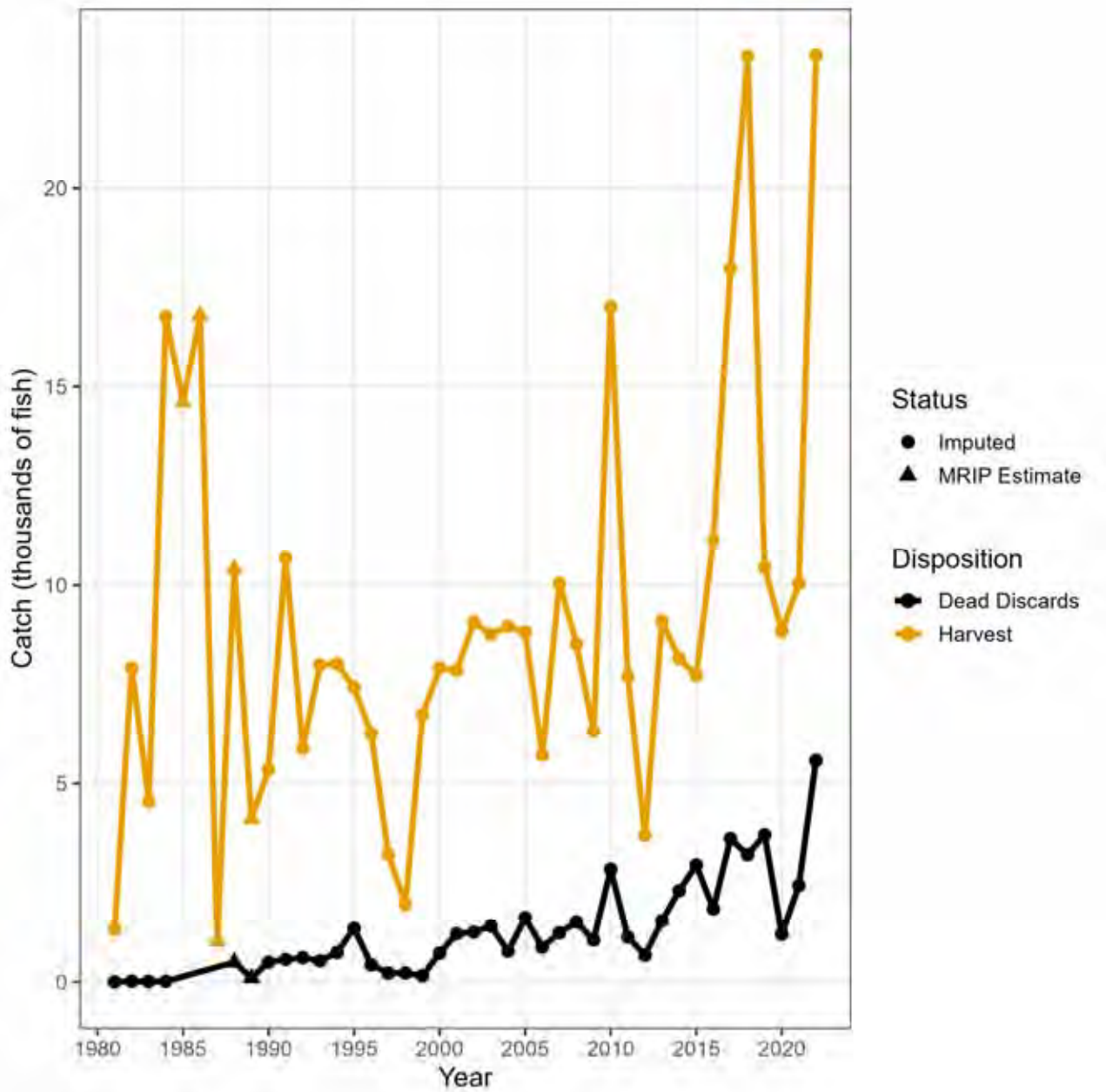


Figure 43. Wave 1 recreational catch estimates of red drum from Georgia provided by MRIP and imputed with ratios of wave 1 to waves 2-6 MRIP catch estimates.

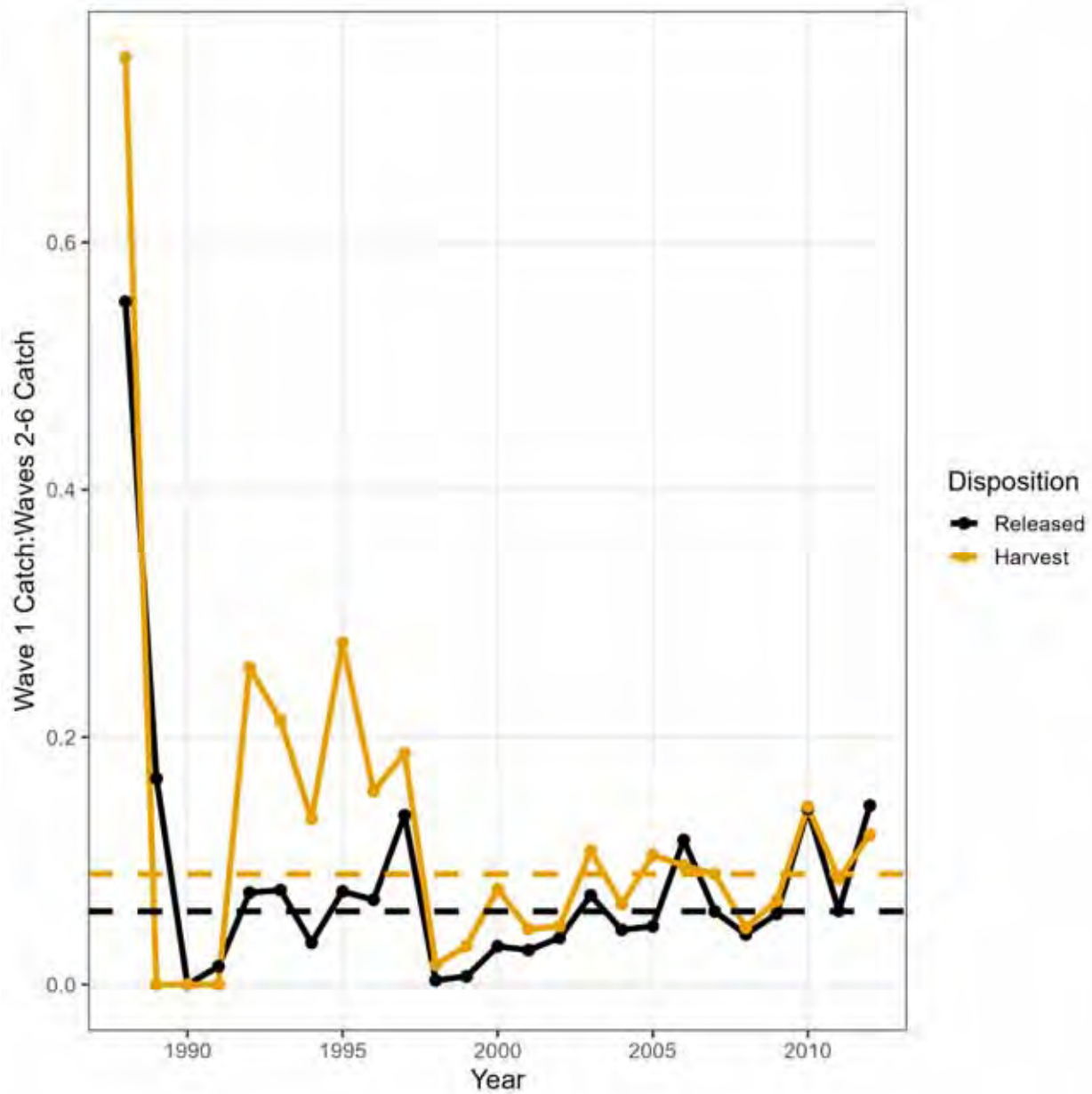


Figure 44. Ratios of wave 1 to waves 2-6 State Finfish Survey catch frequencies from South Carolina. Dashed horizontal lines show medians of annual ratios.

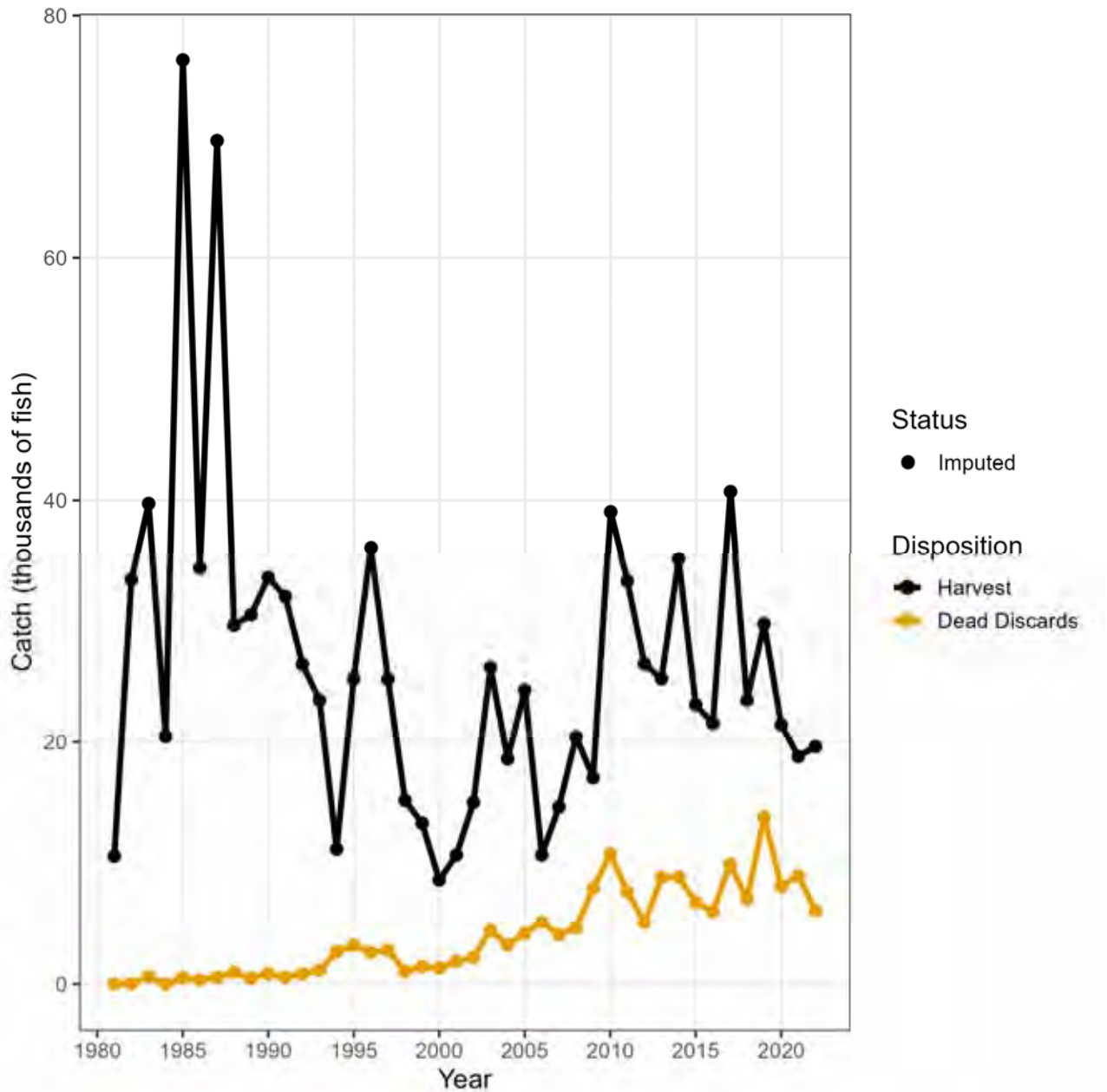


Figure 45. Wave 1 recreational catch estimates of red drum from South Carolina provided by MRIP and imputed with ratios of wave 1 to waves 2-6 State Finfish Survey catch frequencies.

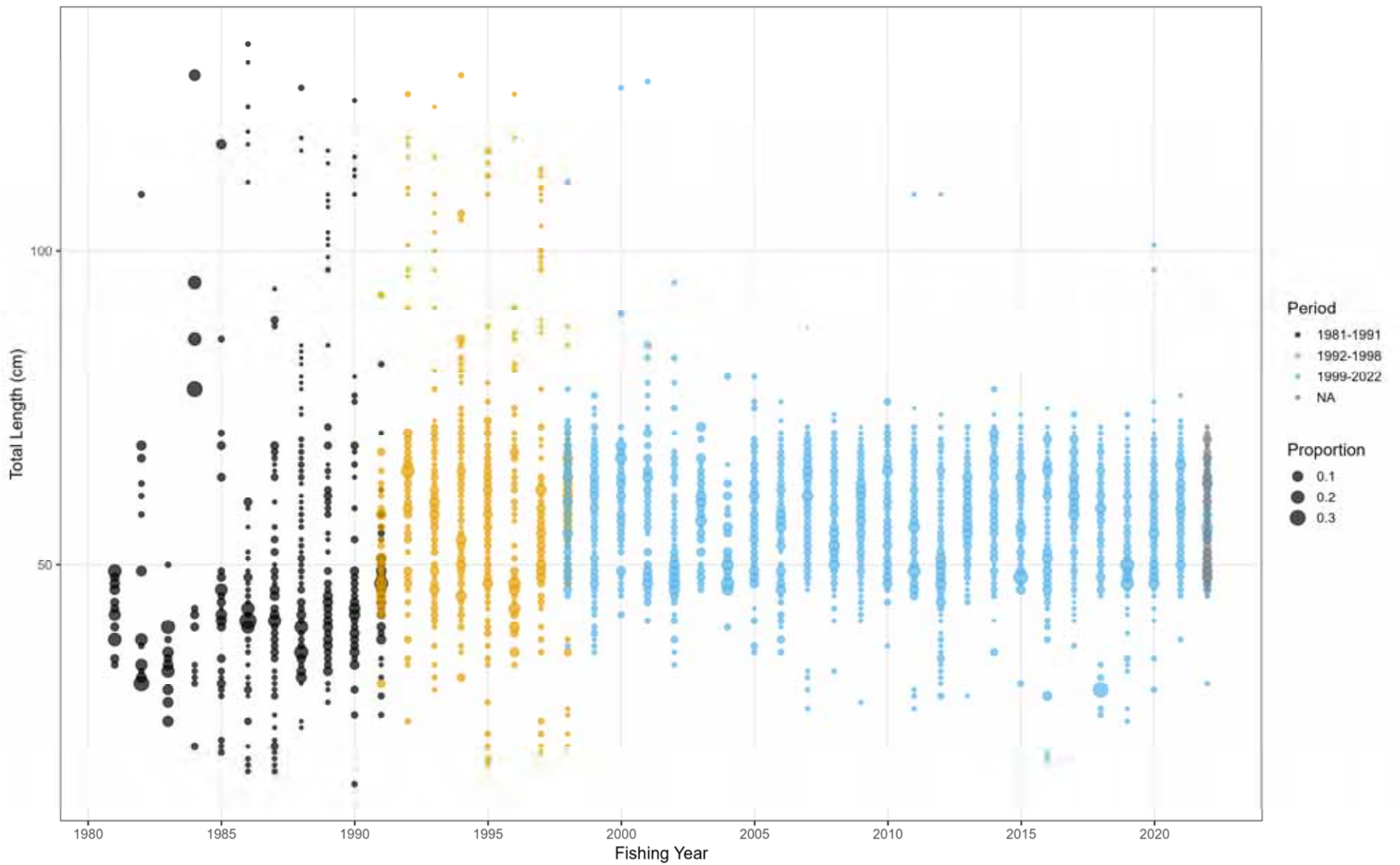
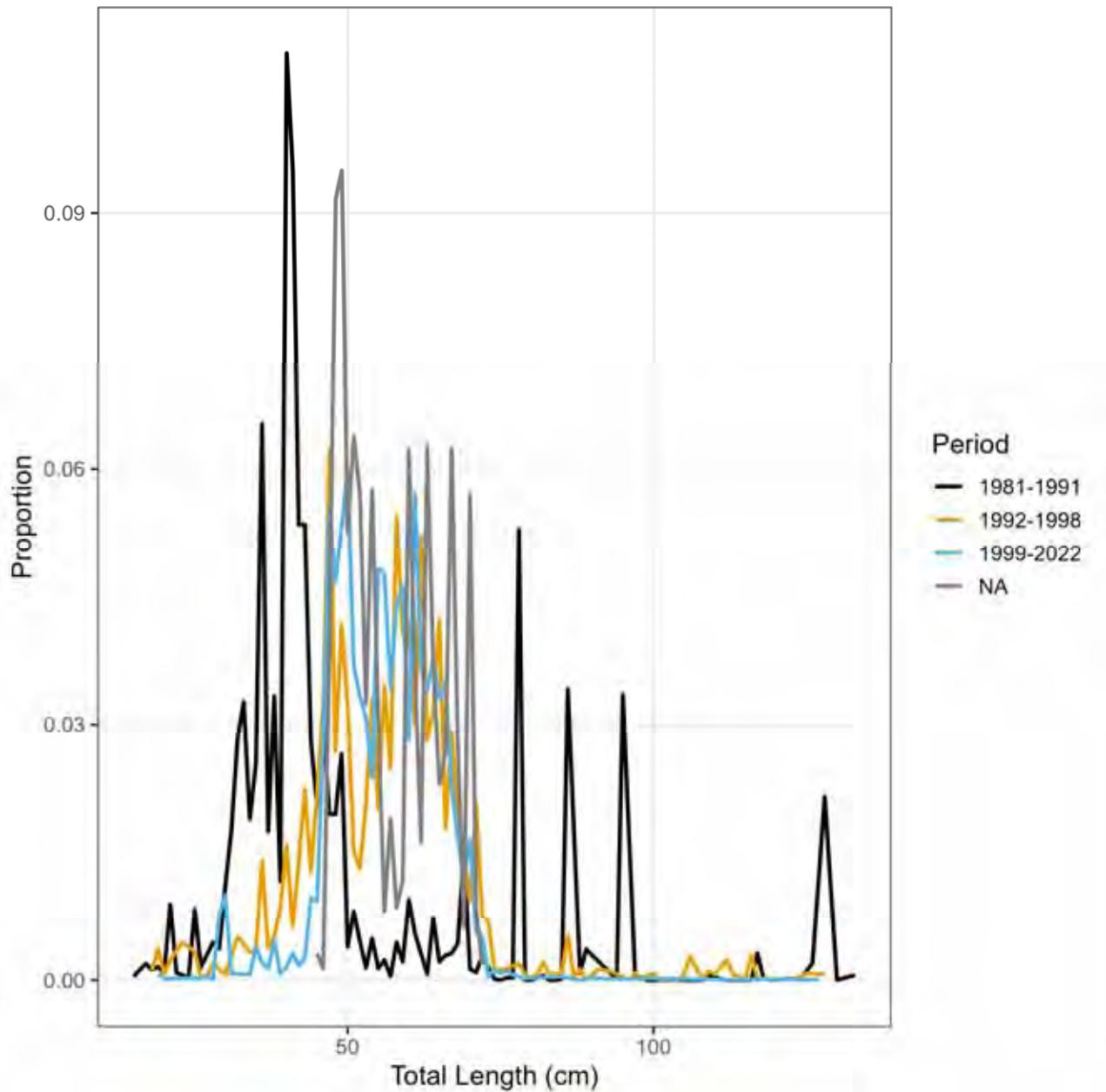
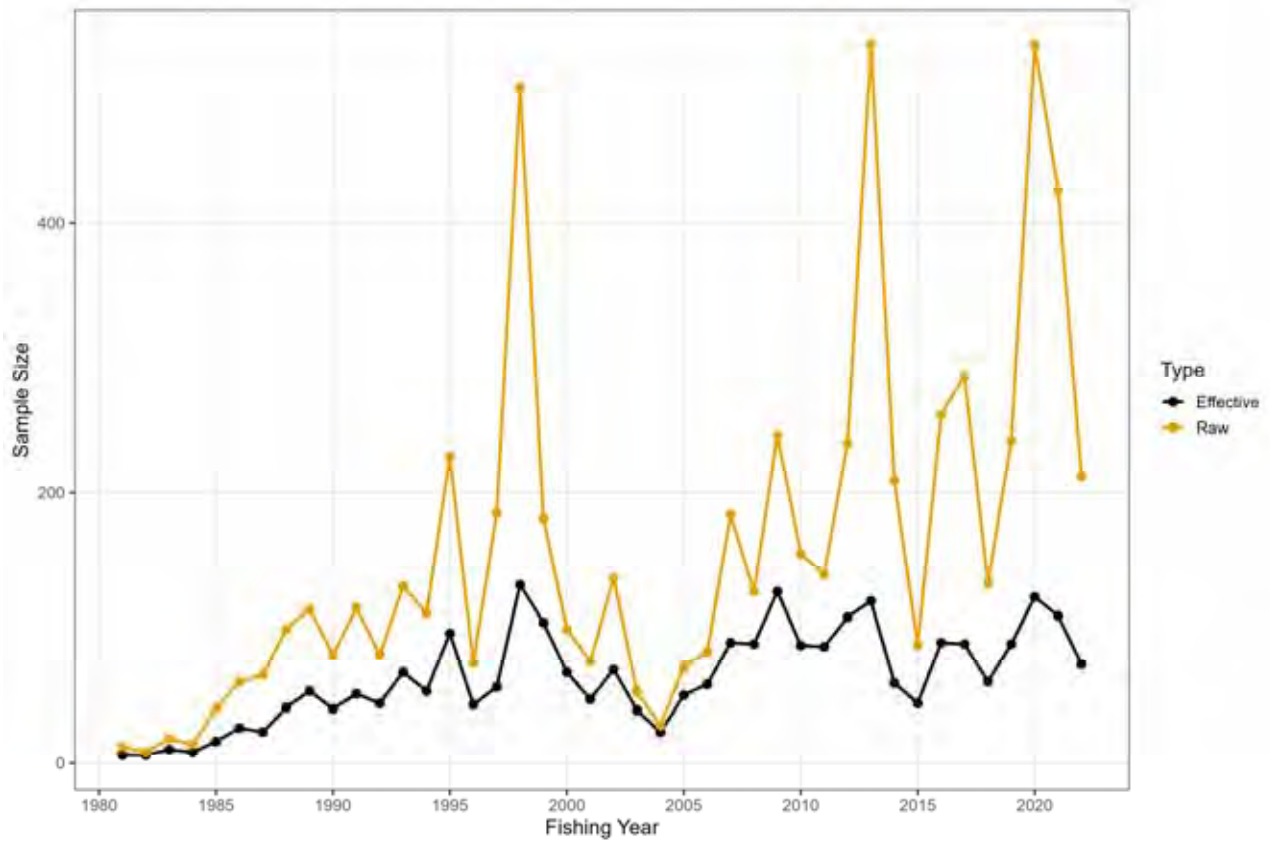


Figure 46. MRIP size composition estimates of recreational red drum harvest from the northern stock. \*\*2022 data are preliminary.



**Figure 47. MRIP size composition estimates of recreational red drum harvest from the northern stock aggregated by regulation periods. \*\*2022 data are preliminary.**



**Figure 48. Number of MRIP primary sampling units that encountered red drum in the northern stock for length measurements (effective) and number of individual red drum measured for length (raw). \*\*2022 data are preliminary.**



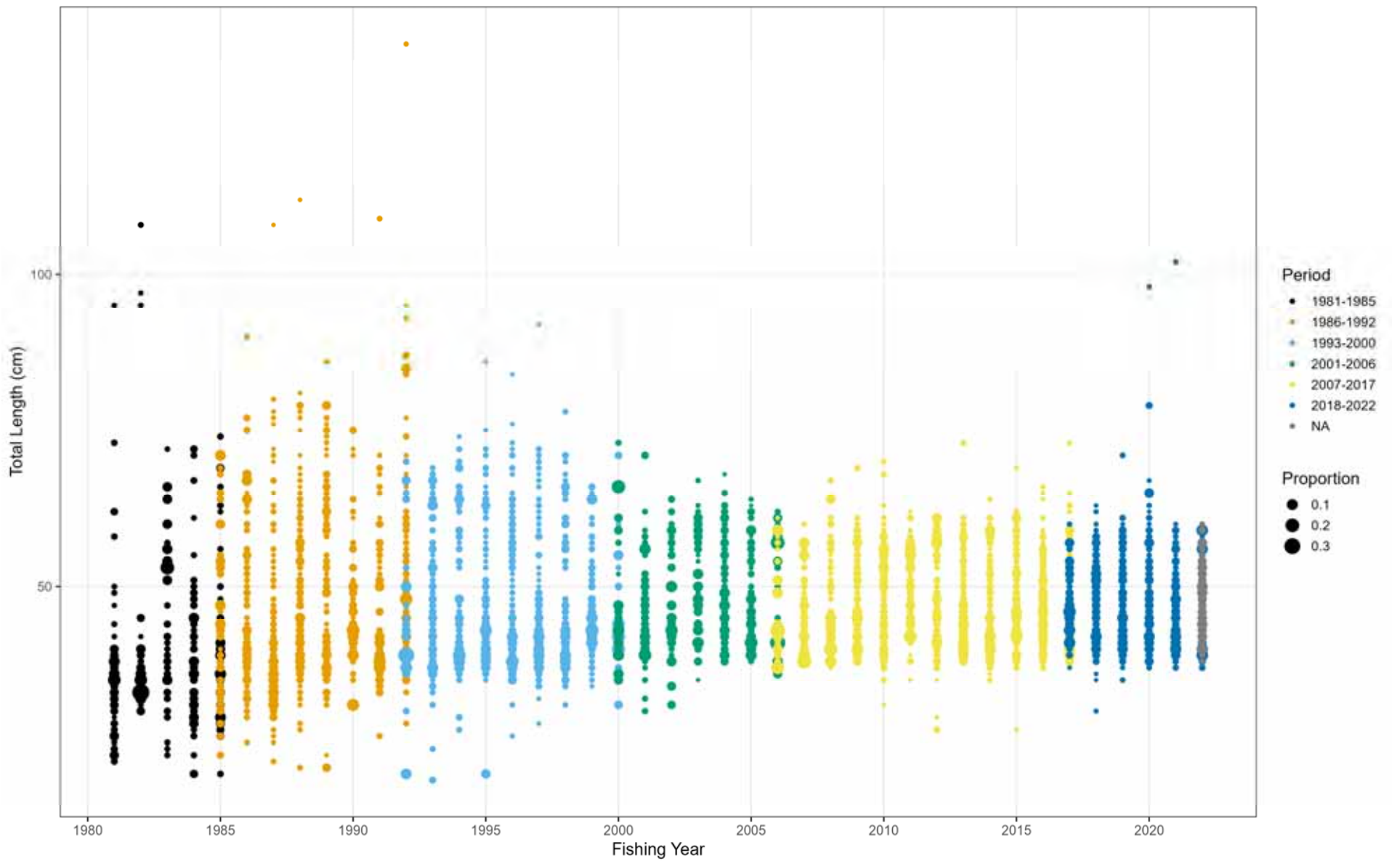


Figure 49. MRIP size composition estimates of recreational red drum harvest from South Carolina in the southern stock. \*\*2022 data are preliminary.

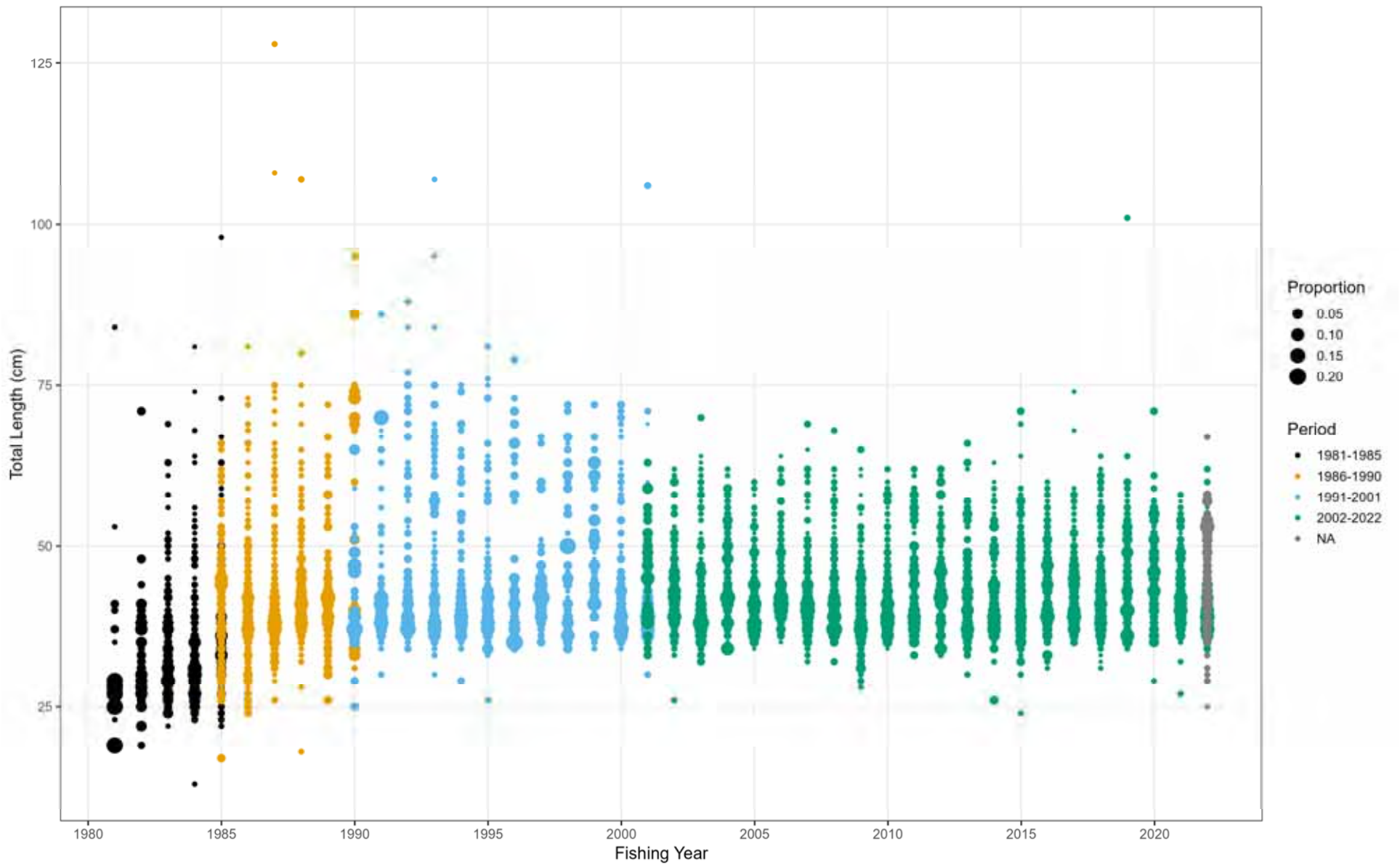


Figure 50. MRIP size composition estimates of recreational red drum harvest from Georgia in the southern stock. \*\*2022 data are preliminary.



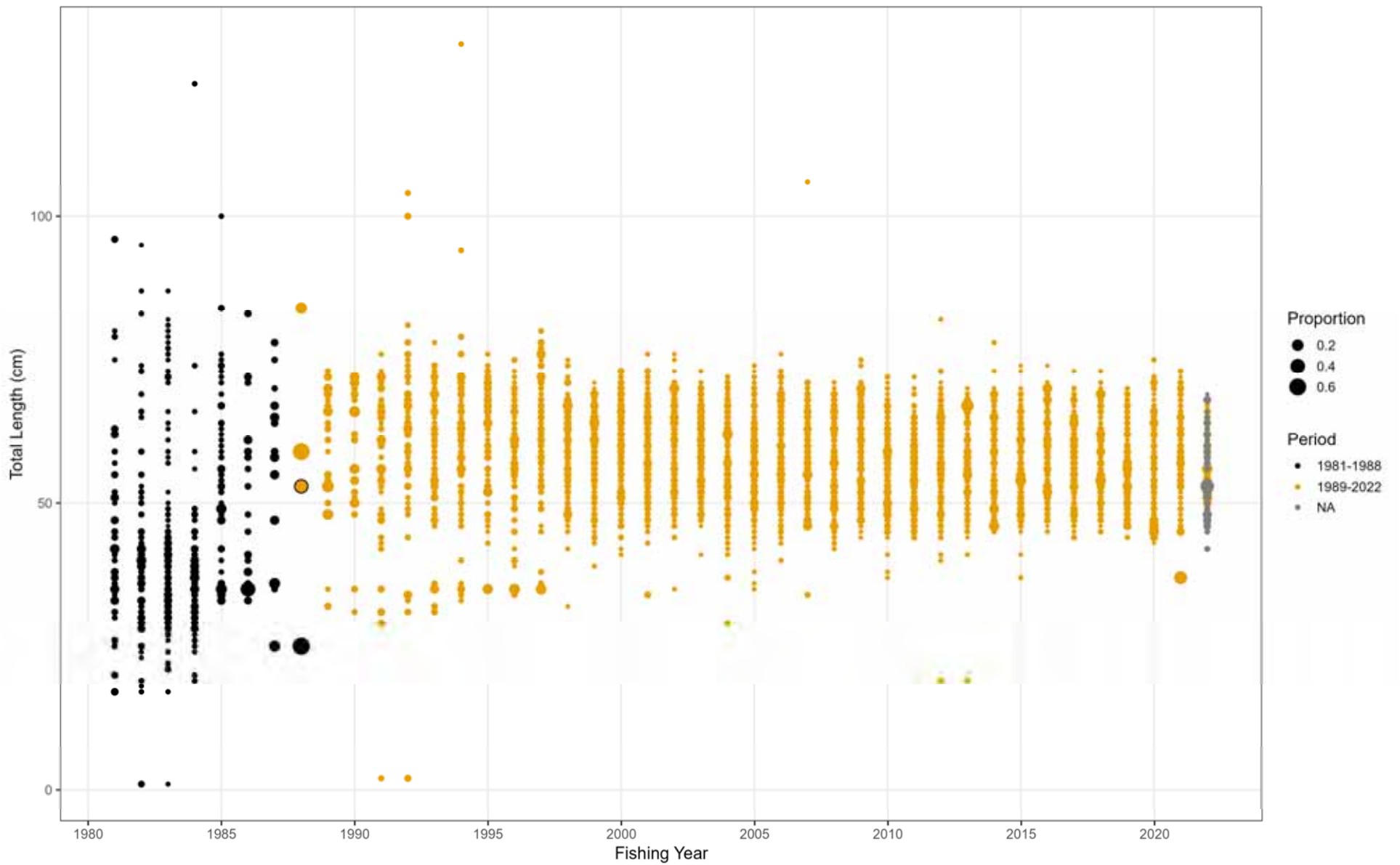
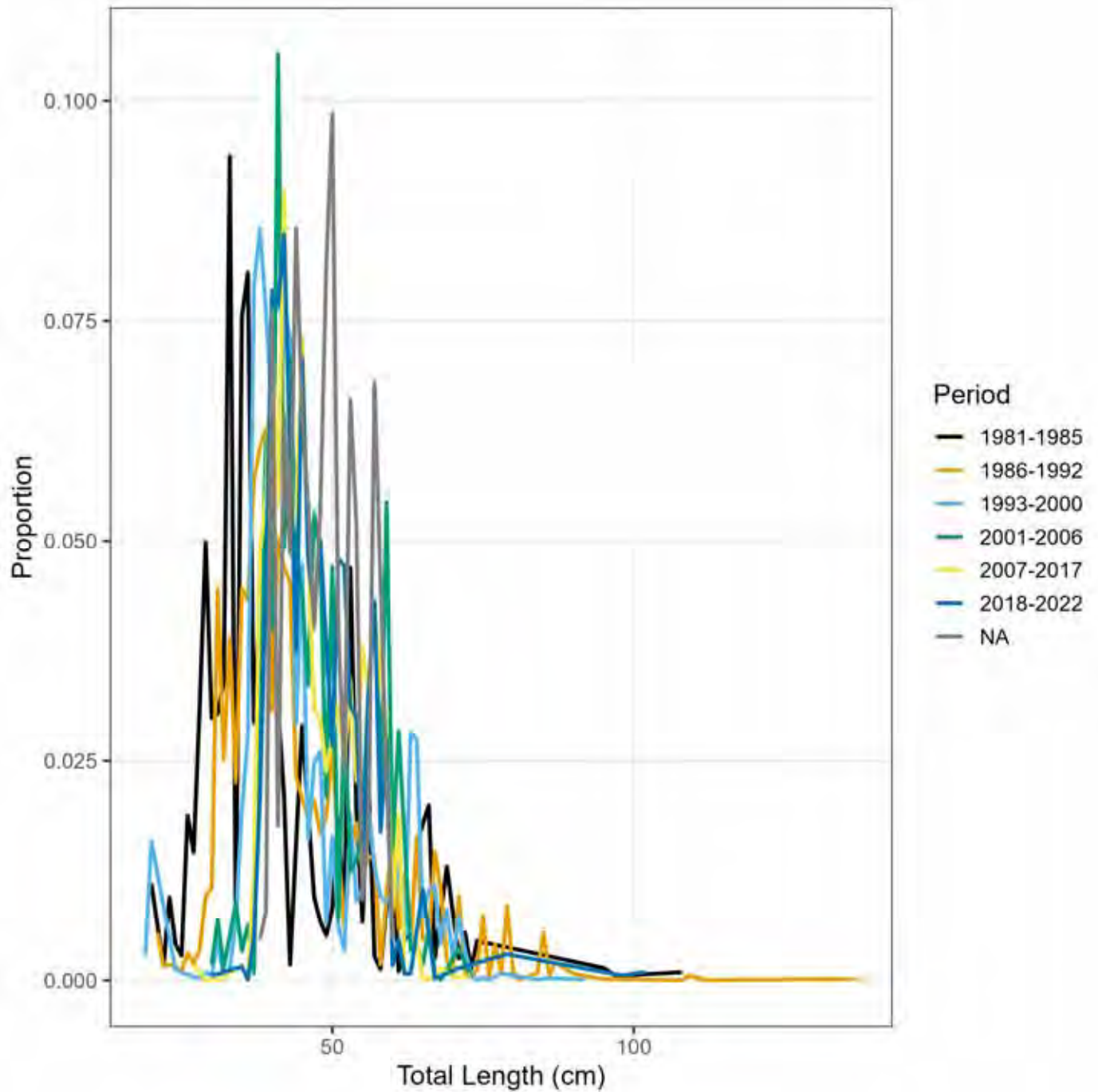
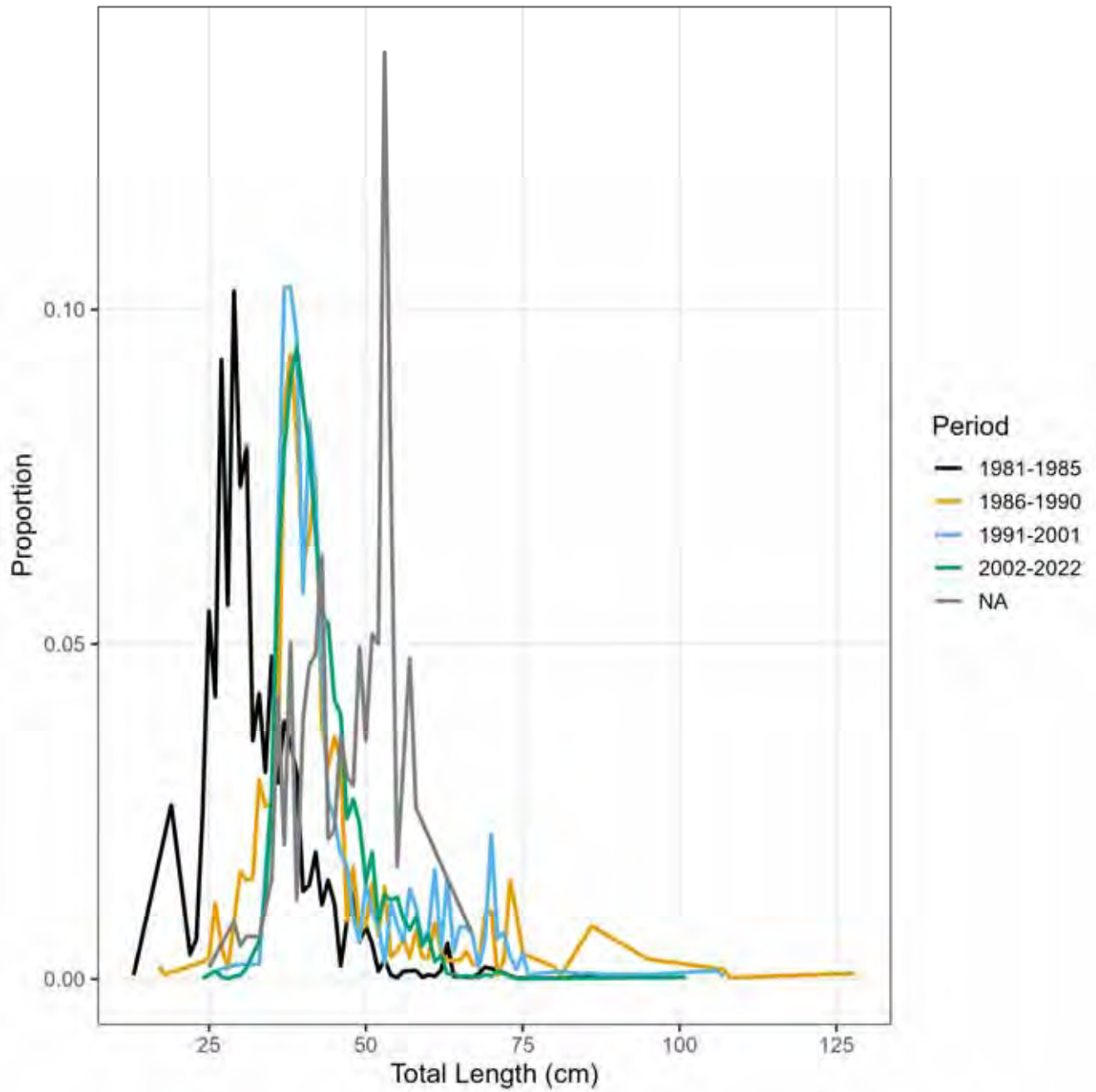


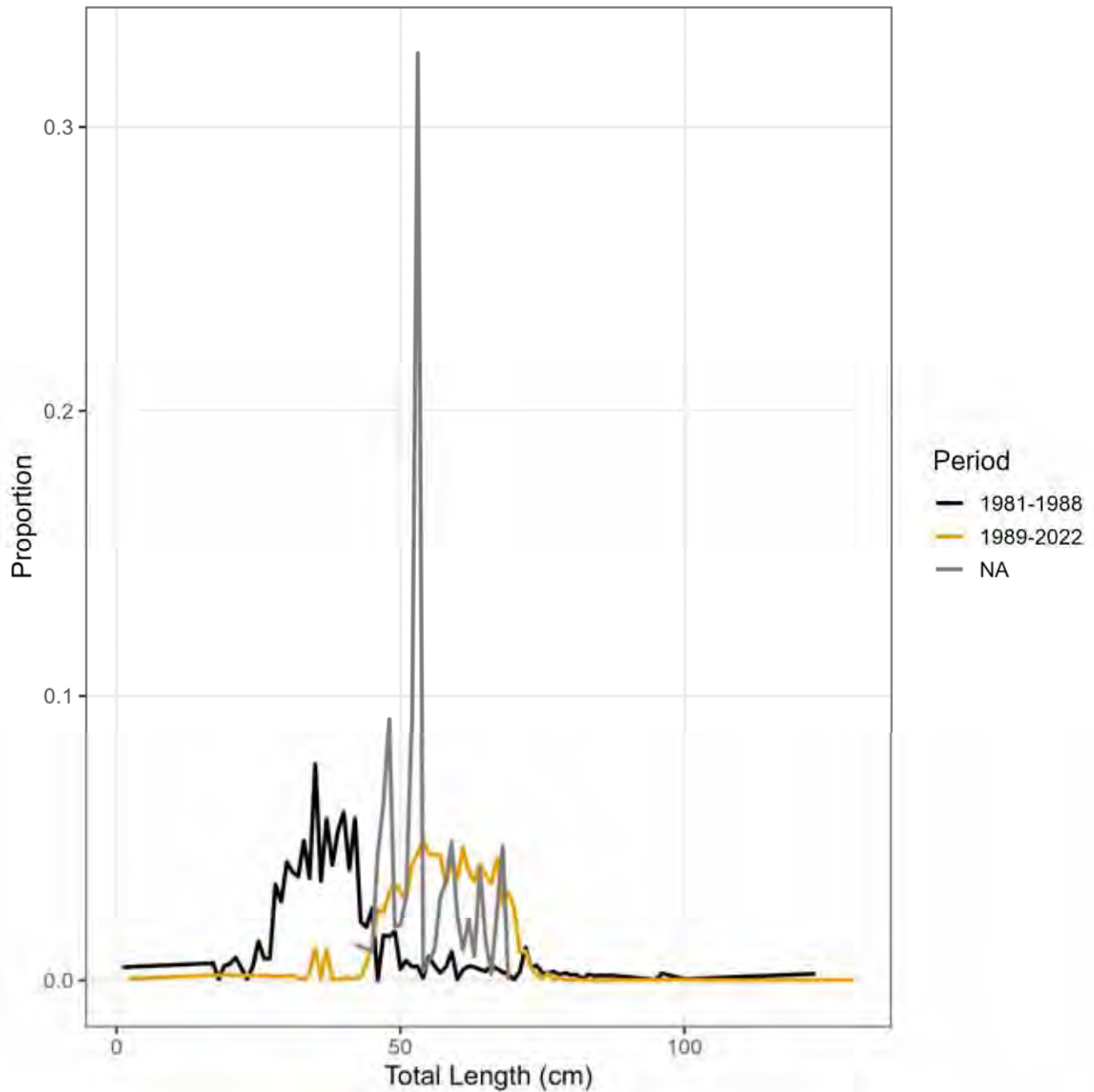
Figure 51. MRIP size composition estimates of recreational red drum harvest from Florida in the southern stock. \*\*2022 data are preliminary.



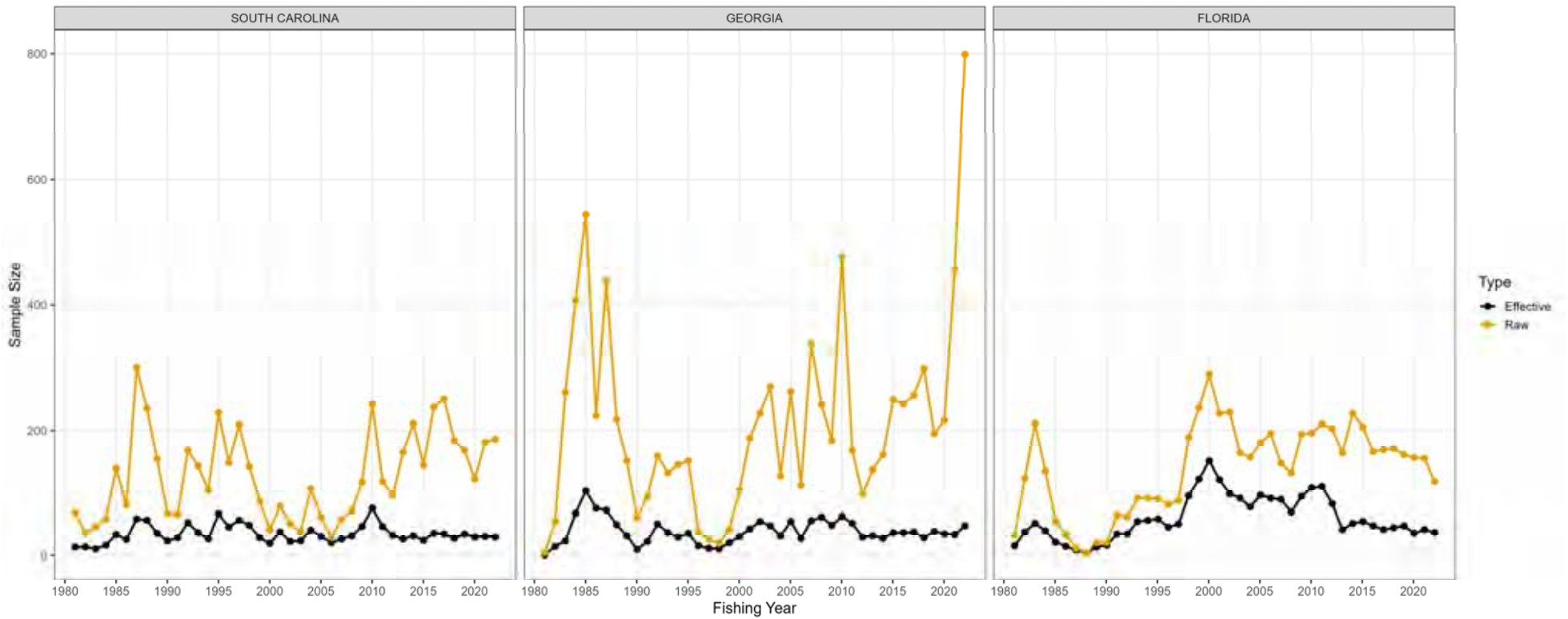
**Figure 52. MRIP size composition estimates of recreational red drum harvest from South Carolina aggregated by regulation periods. \*\*2022 data are preliminary.**



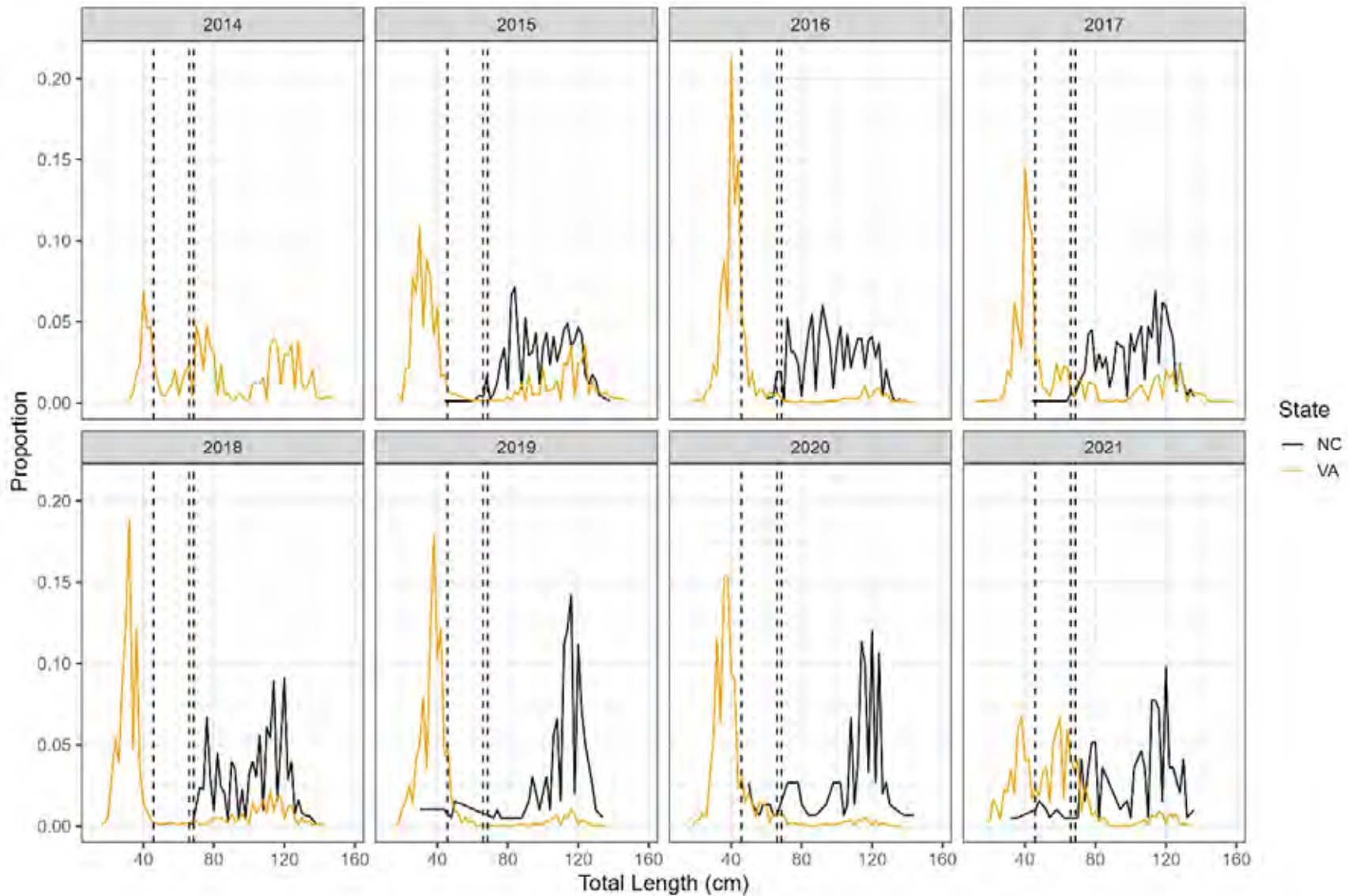
**Figure 53. MRIP size composition estimates of recreational red drum harvest from Georgia aggregated by regulation periods. \*\*2022 data are preliminary.**



**Figure 54. MRIP size composition estimates of recreational red drum harvest from Florida aggregated by regulation periods. \*\*2022 data are preliminary.**

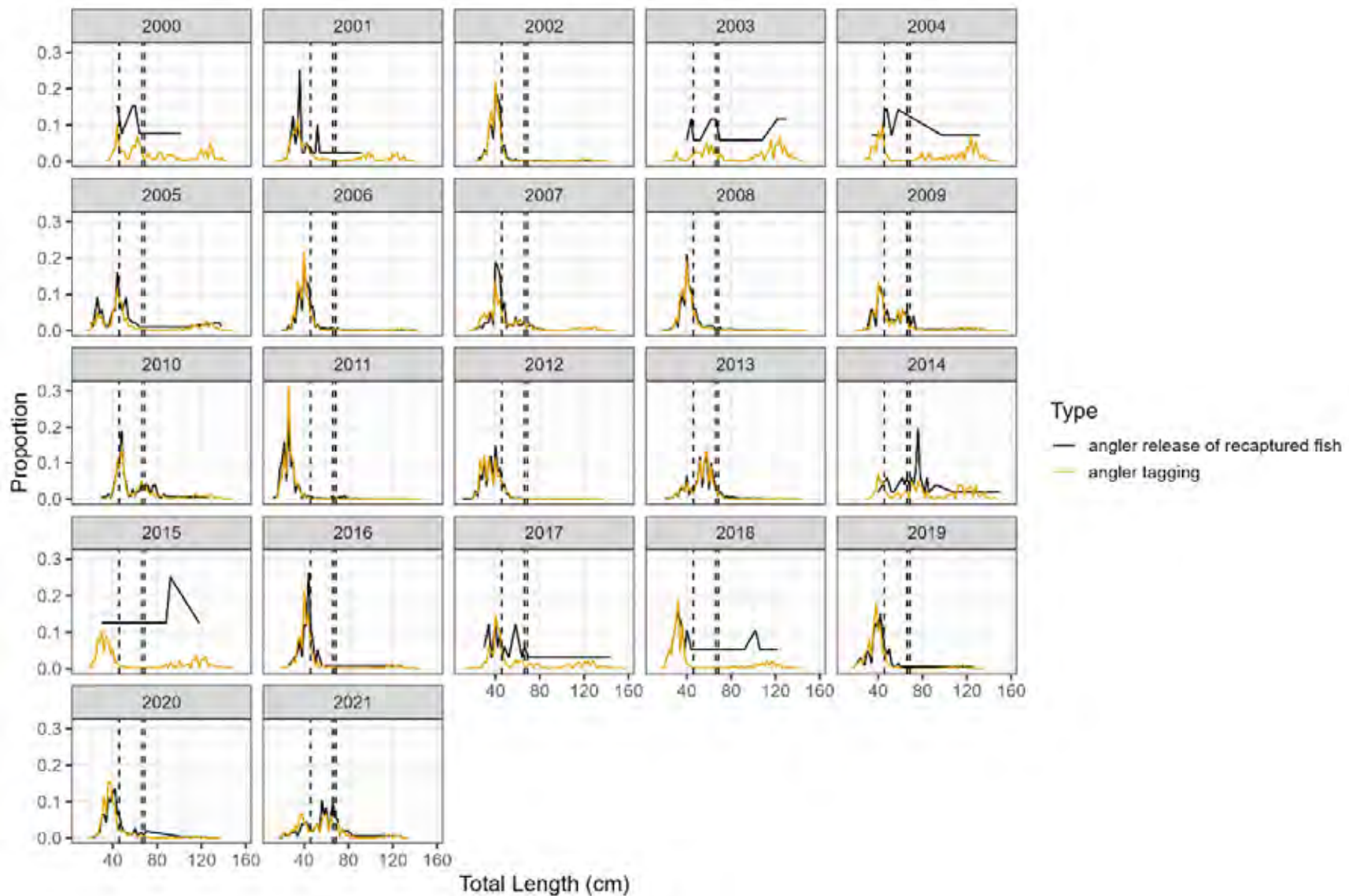


**Figure 55. Number of MRIP primary sampling units that encountered red drum in the southern stock for length measurements (effective) and number of individual red drum measured for length (raw). \*\*2022 data are preliminary.**

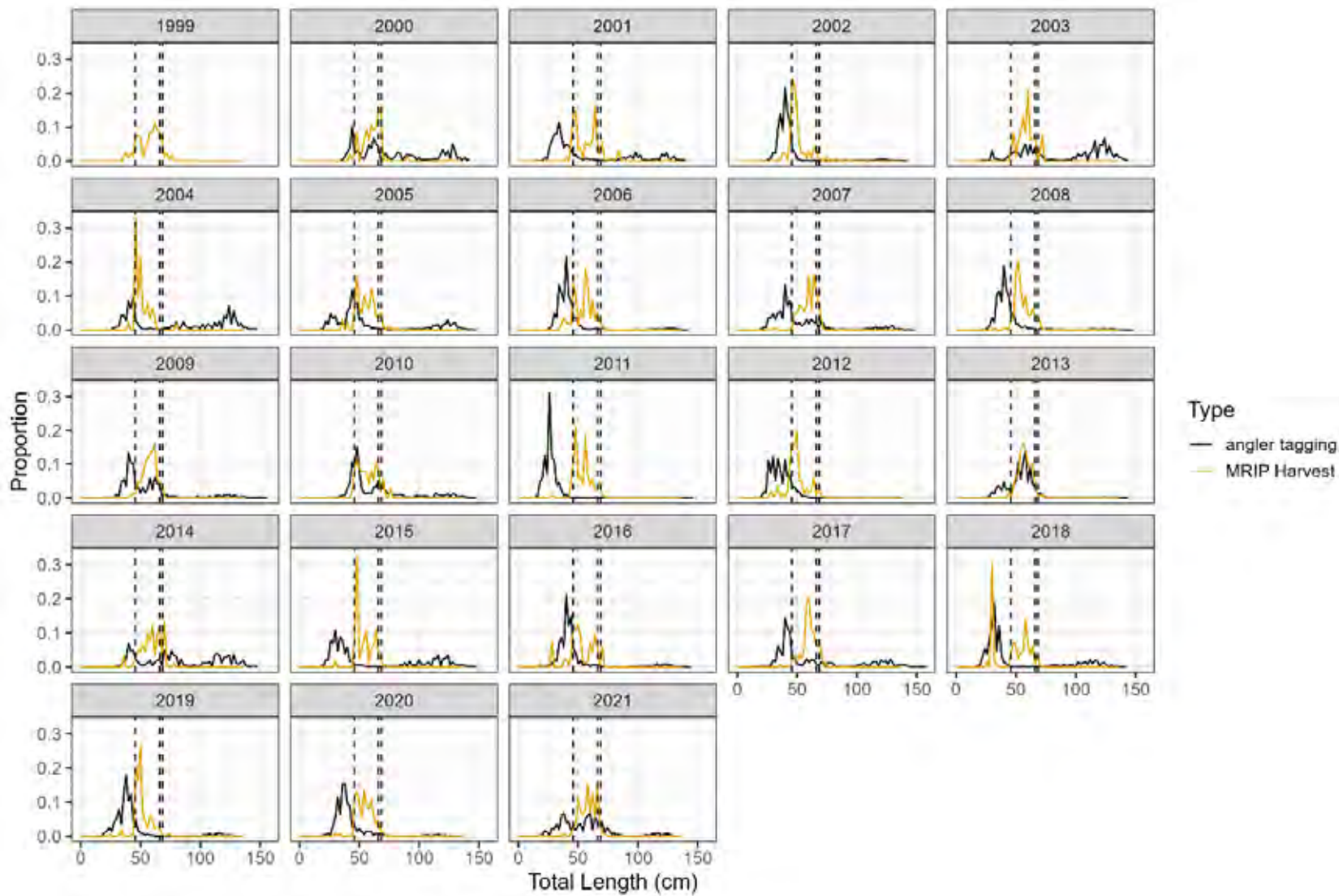


**Figure 56. Size distributions of red drum tagged by volunteer anglers participating in the North Carolina Fish Tagging Program and Virginia Game Fish Tagging Program. Horizontal dashed lines indicate slot sizes in place in North Carolina and Virginia in recent years.**



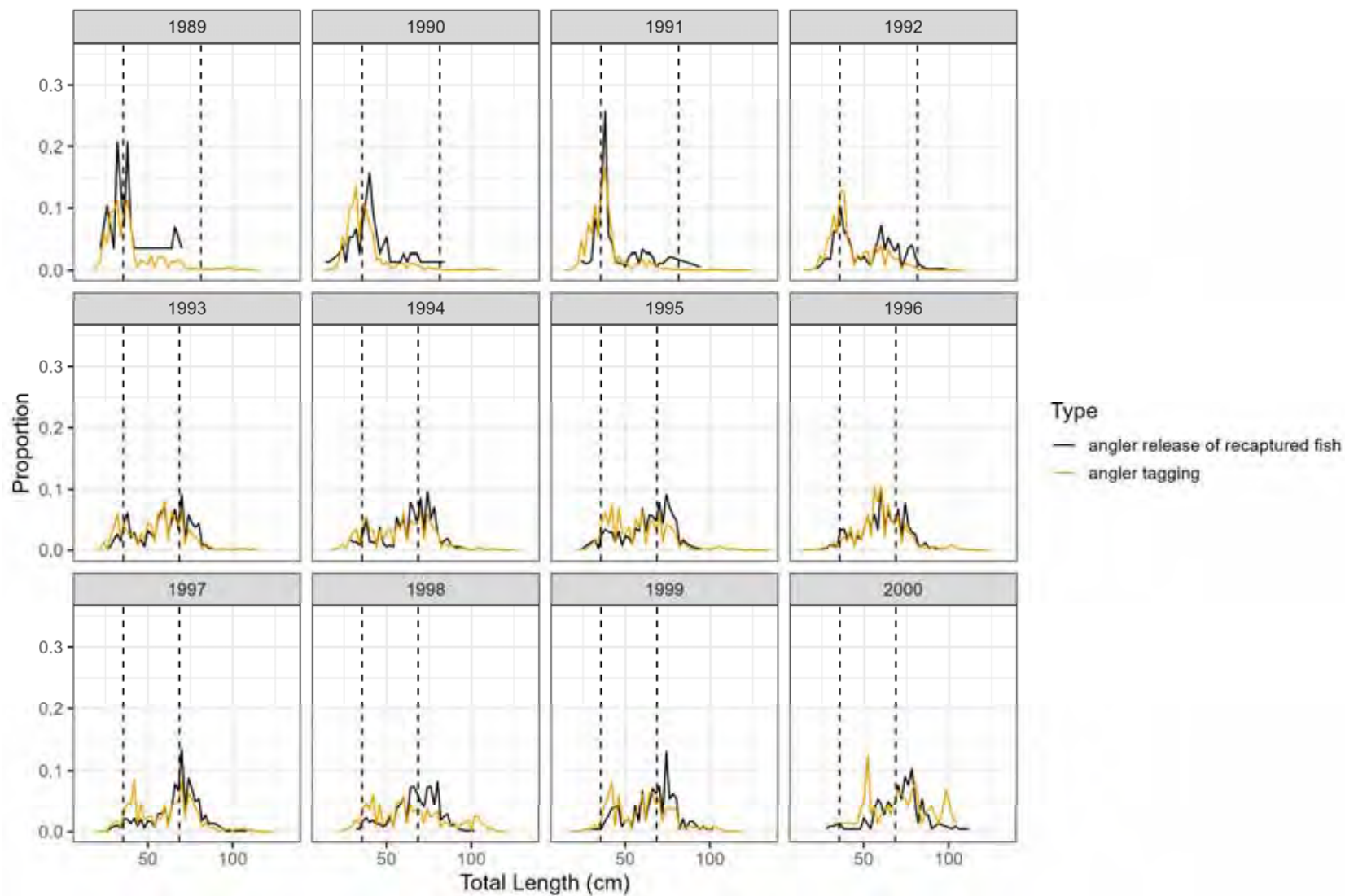


**Figure 57. Size distributions of red drum tagged by volunteer anglers and recaptured and subsequently released by anglers participating in the Virginia Game Fish Tagging Program. Horizontal dashed lines indicate slot sizes in place in North Carolina and Virginia in recent years.**

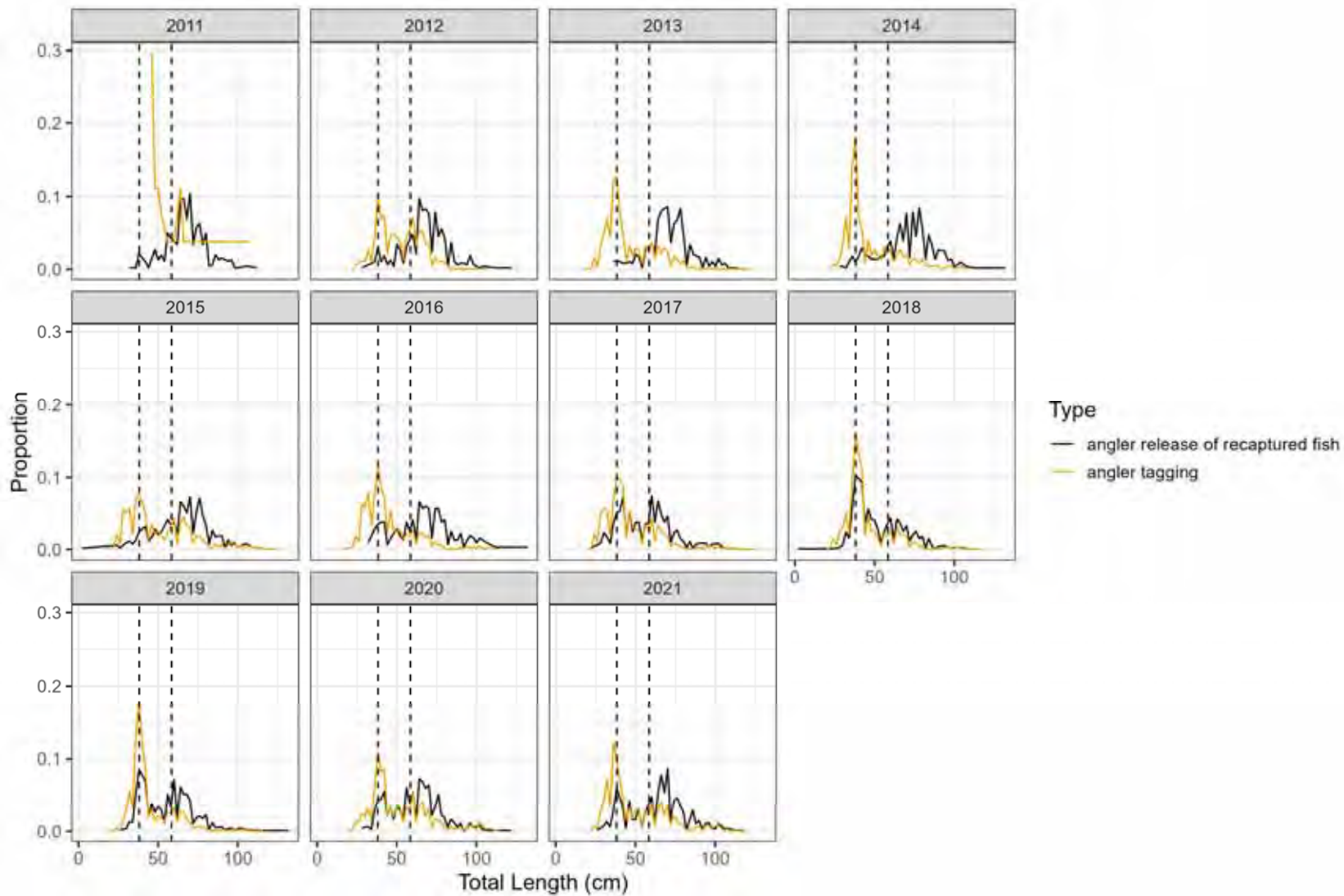


**Figure 58. Size distributions of red drum tagged by volunteer anglers participating in the Virginia Game Fish Tagging Program and of harvested red drum from MRIP estimates for the northern stock. Horizontal dashed lines indicate slot sizes in place in North Carolina and Virginia in recent years.**

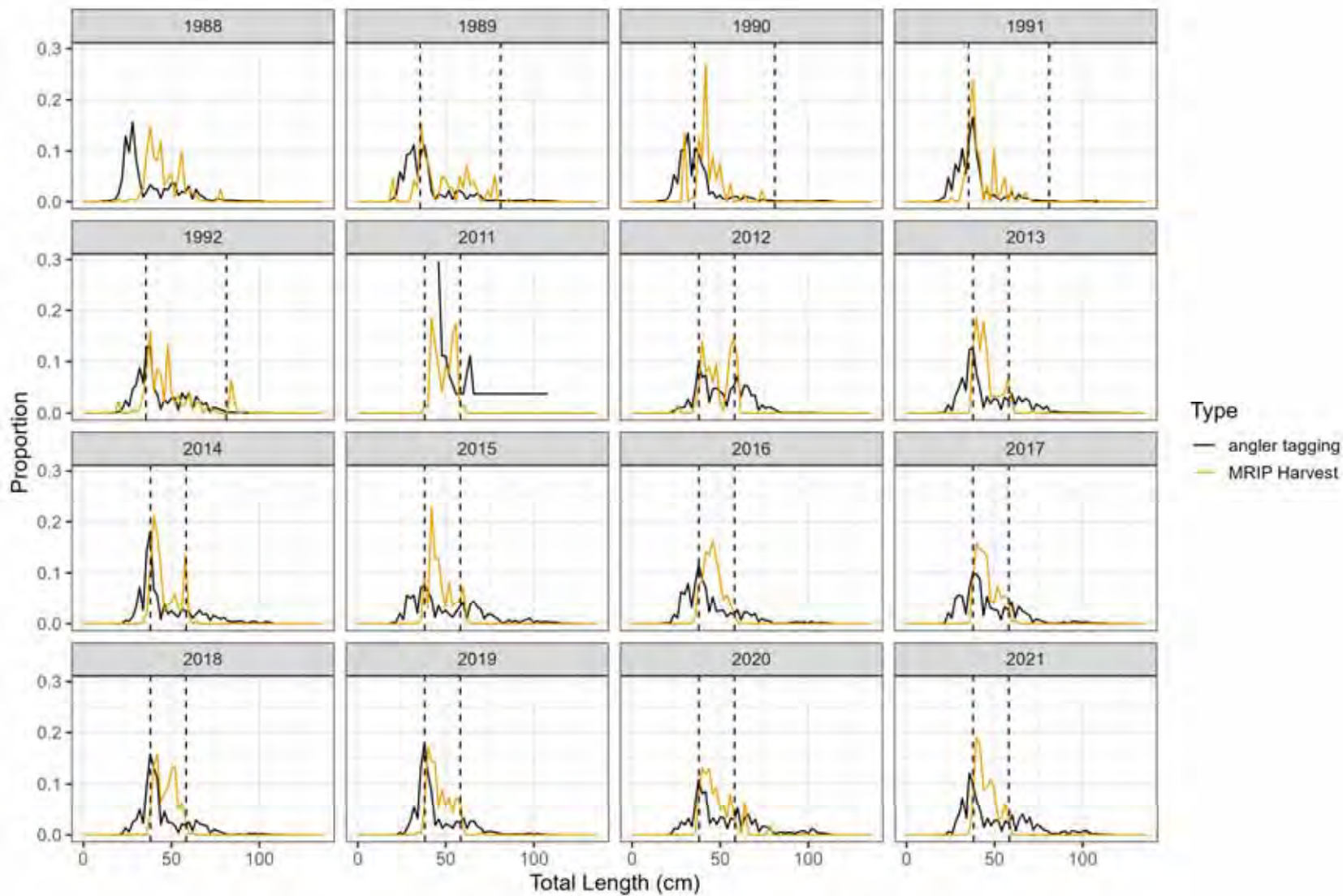




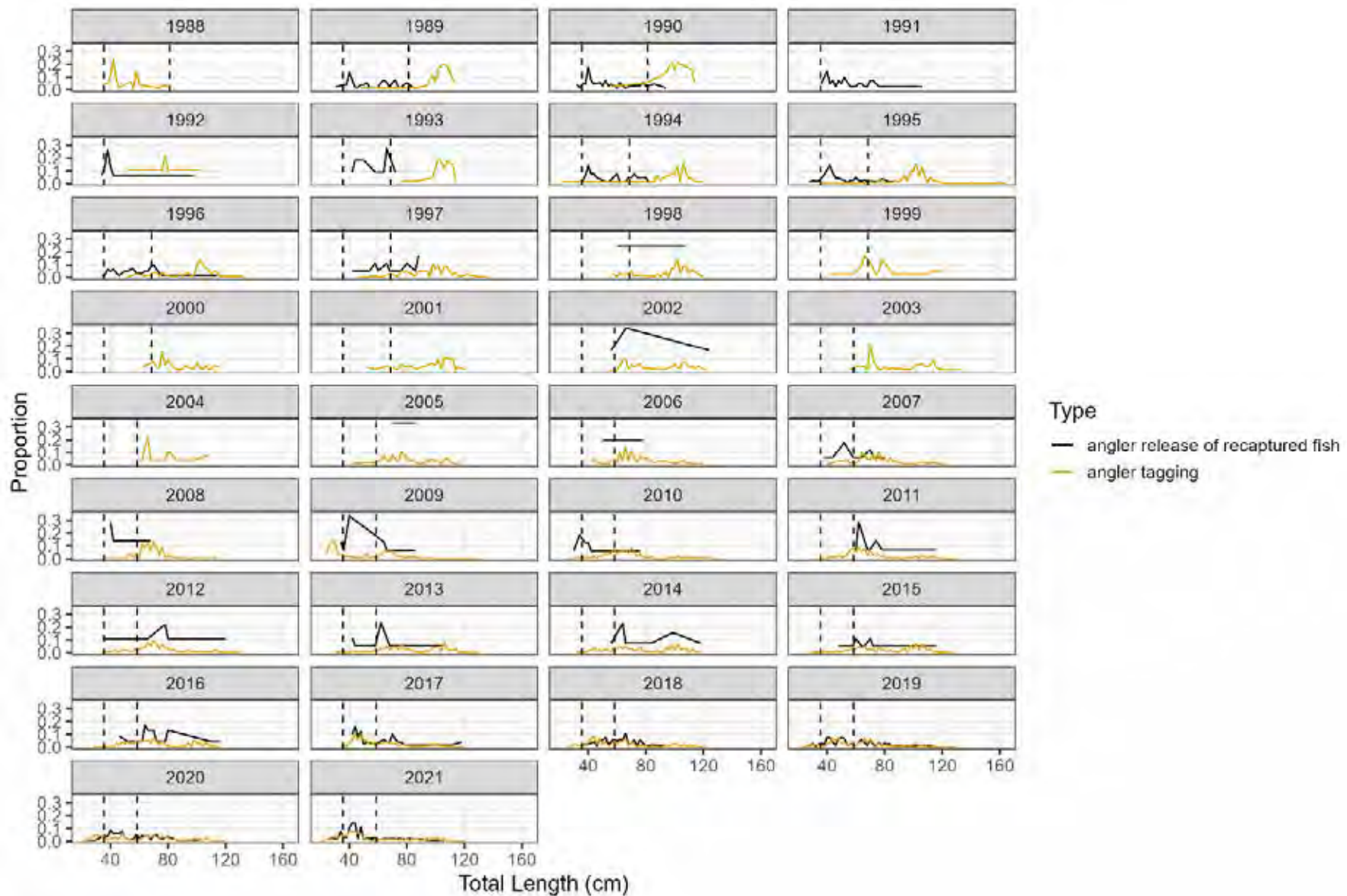
**Figure 59. Size distributions of red drum tagged by volunteer anglers and recaptured and subsequently released by anglers participating in the South Carolina Marine Game Fish Tagging Program from 1989-2000. Horizontal dashed lines indicate slot size in place in South Carolina in recent years.**



**Figure 60. Size distributions of red drum tagged by volunteer anglers and recaptured and subsequently released by anglers participating in the South Carolina Marine Game Fish Tagging Program from 2011-2021. Horizontal dashed lines indicate slot size in place in South Carolina in recent years.**

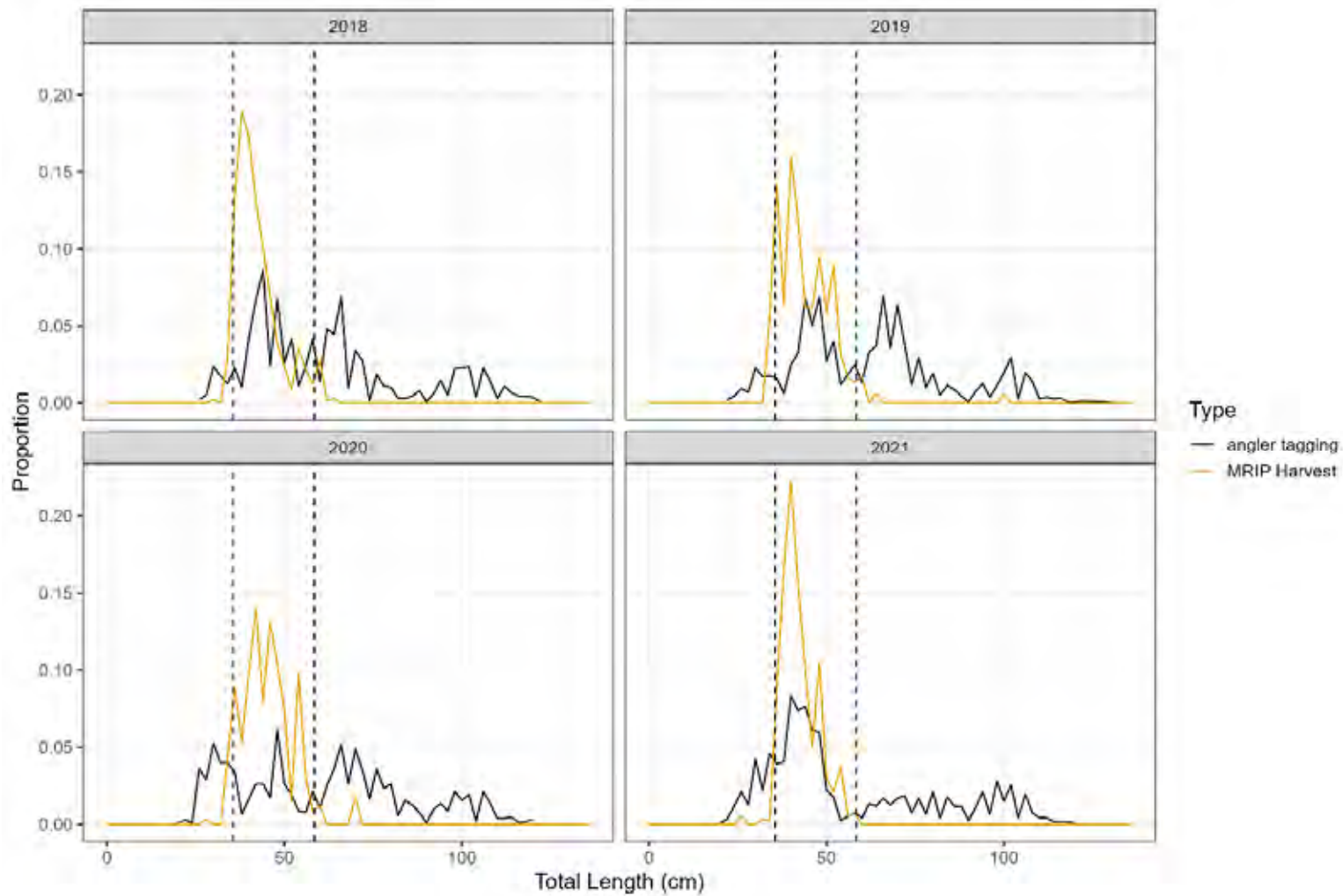


**Figure 61. Size distributions of red drum tagged by volunteer anglers participating in the South Carolina Marine Game Fish Tagging Program and of harvested red drum from MRIP estimates for South Carolina from 1989-1992 and 2011-2021. Horizontal dashed lines indicate slot sizes in place in South Carolina in recent years.**

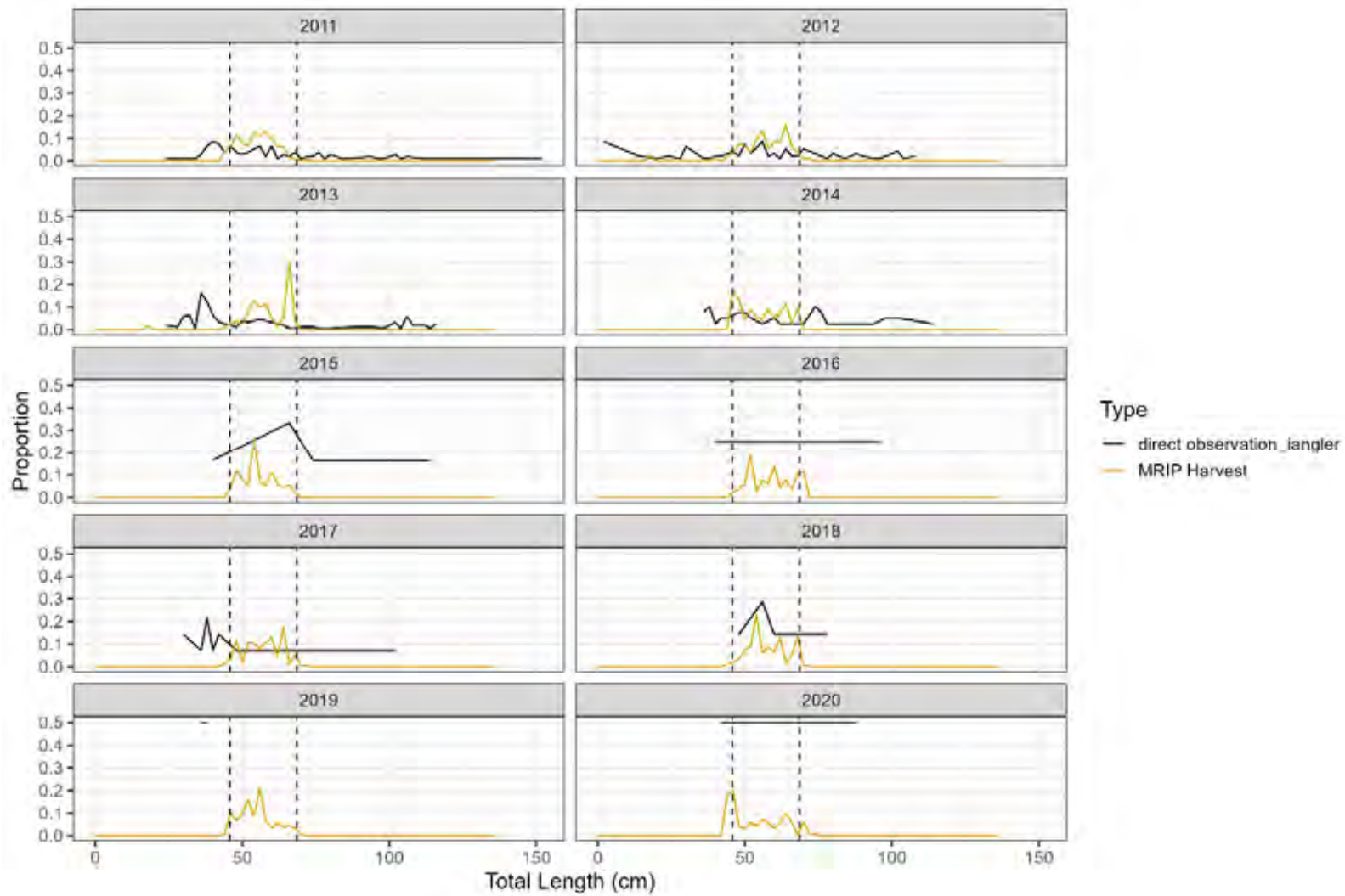


**Figure 62. Size distributions of red drum tagged by volunteer anglers and recaptured and subsequently released by anglers participating in the Georgia Cooperative Angler Tagging Project. Horizontal dashed lines indicate slot size in place in Georgia in recent years.**





**Figure 63. Size distributions of red drum tagged by volunteer anglers participating in the Georgia Cooperative Angler Tagging Project and of harvested red drum from MRIP estimates for Georgia from 2018-2021. Horizontal dashed lines indicate slot sizes in place in Georgia.**



**Figure 64. Size distributions of released red drum reported through the iAngler phone application and of harvested red drum from MRIP estimates for Florida. Horizontal dashed lines indicate slot sizes in place in Florida.**

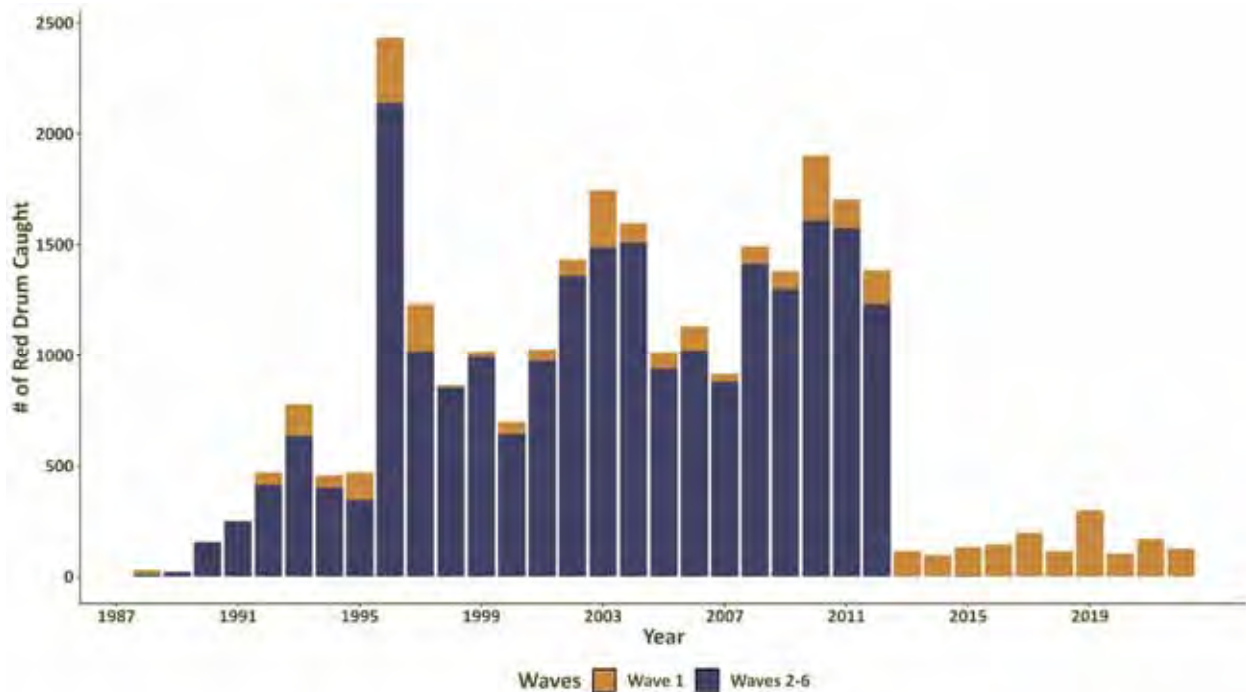


Figure 65. Reported red drum captured during waves 2-6 (March – December; blue bars) and wave 1 (January – February; orange bars) by anglers participating in the SCDNR SFS.

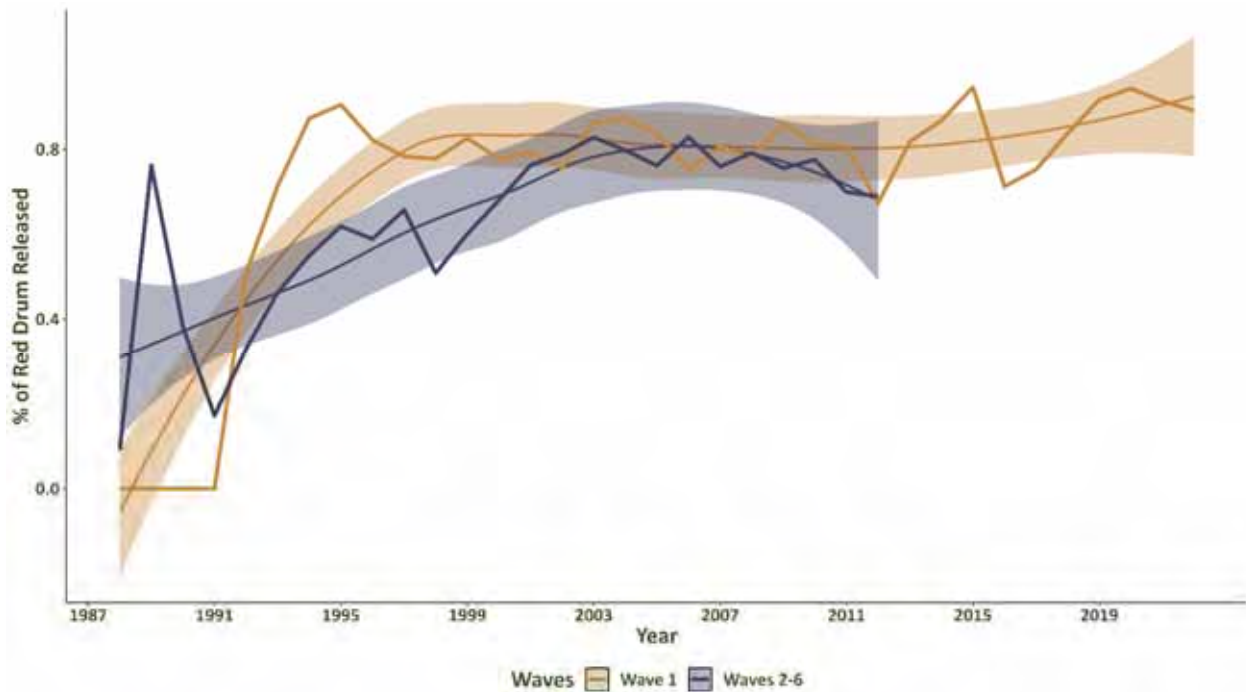


Figure 66. Proportion of red drum released during wave 1 (January – February) and waves 2-6 (March – December) as observed in the SCDNR SFS. Shown are the annual estimates (solid, heavy lines) along with a LOESS smoother of annual estimates with 95% confidence intervals (solid, thin lines with surrounding shaded region).



Figure 67. From top to bottom, the tags above are: Stainless steel anchor “shoulder” dart tags and internal anchor “belly” tags with disk wired to streamer.

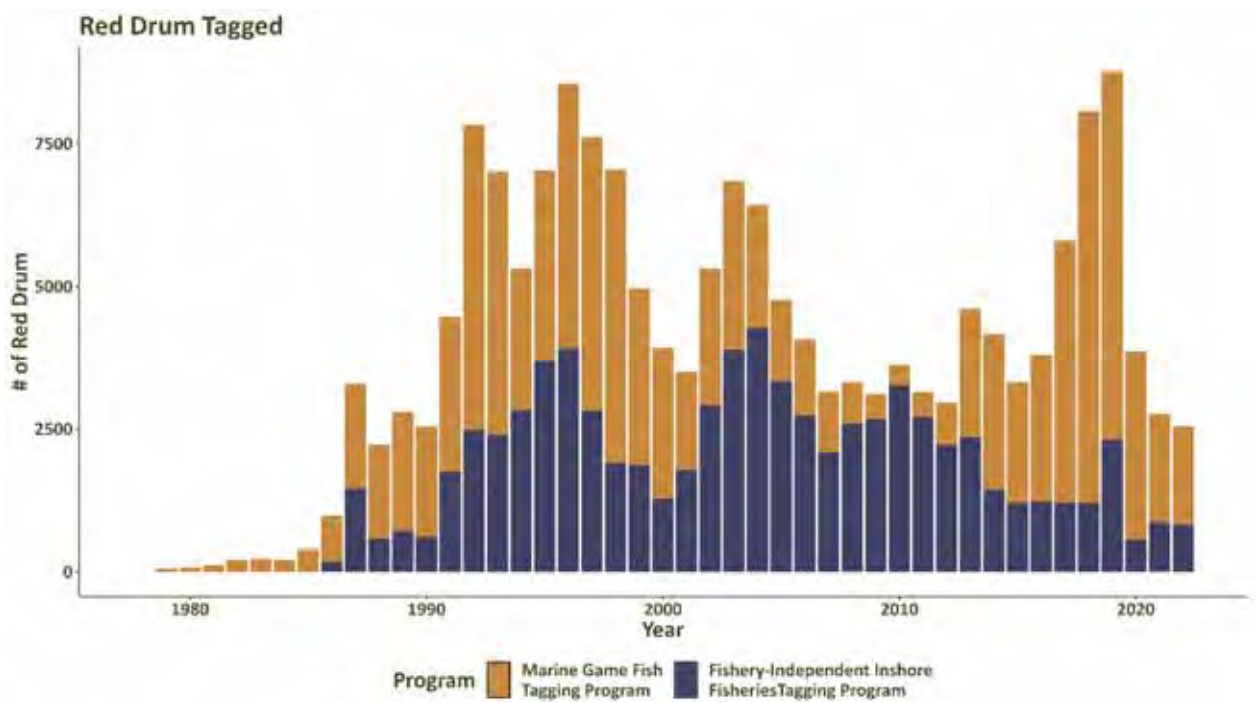


Figure 68. Number of red drum tagged annually in South Carolina by tagging program.



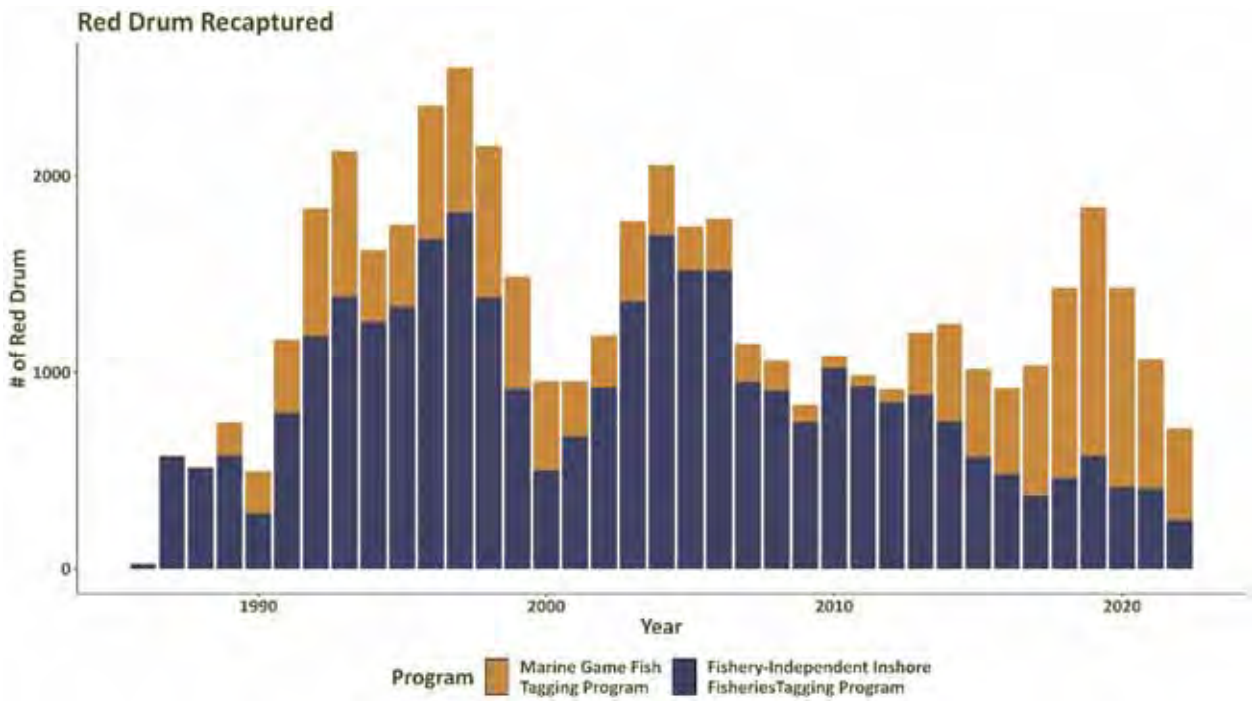


Figure 69. Number of red drum recaptured annually originally tagged as part of SCDNR's conventional tagging program.



Figure 70. Proportion of recaptures released annually for fish tagged as part of the SCDNR conventional tagging programs.

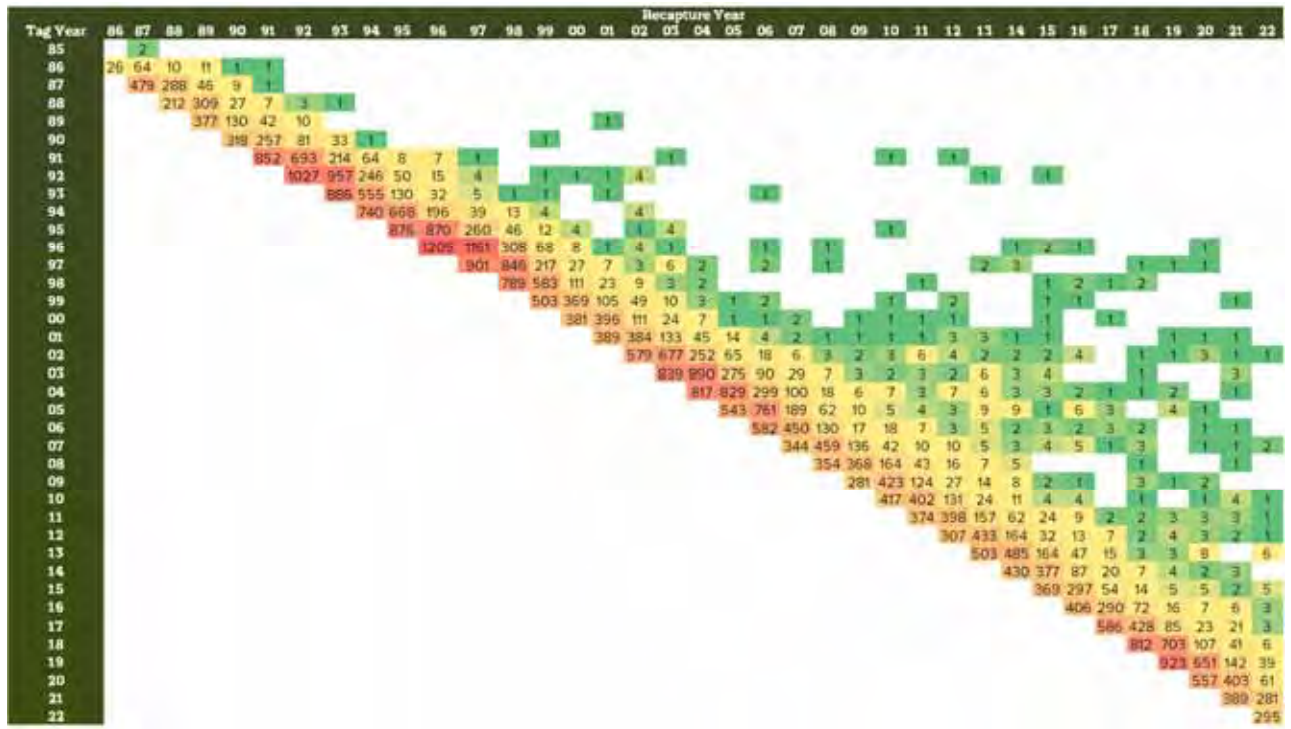


Figure 71. Tag year and recapture year of the >47,800 recaptures of fish tagged as part of the SCDNR conventional tagging program.

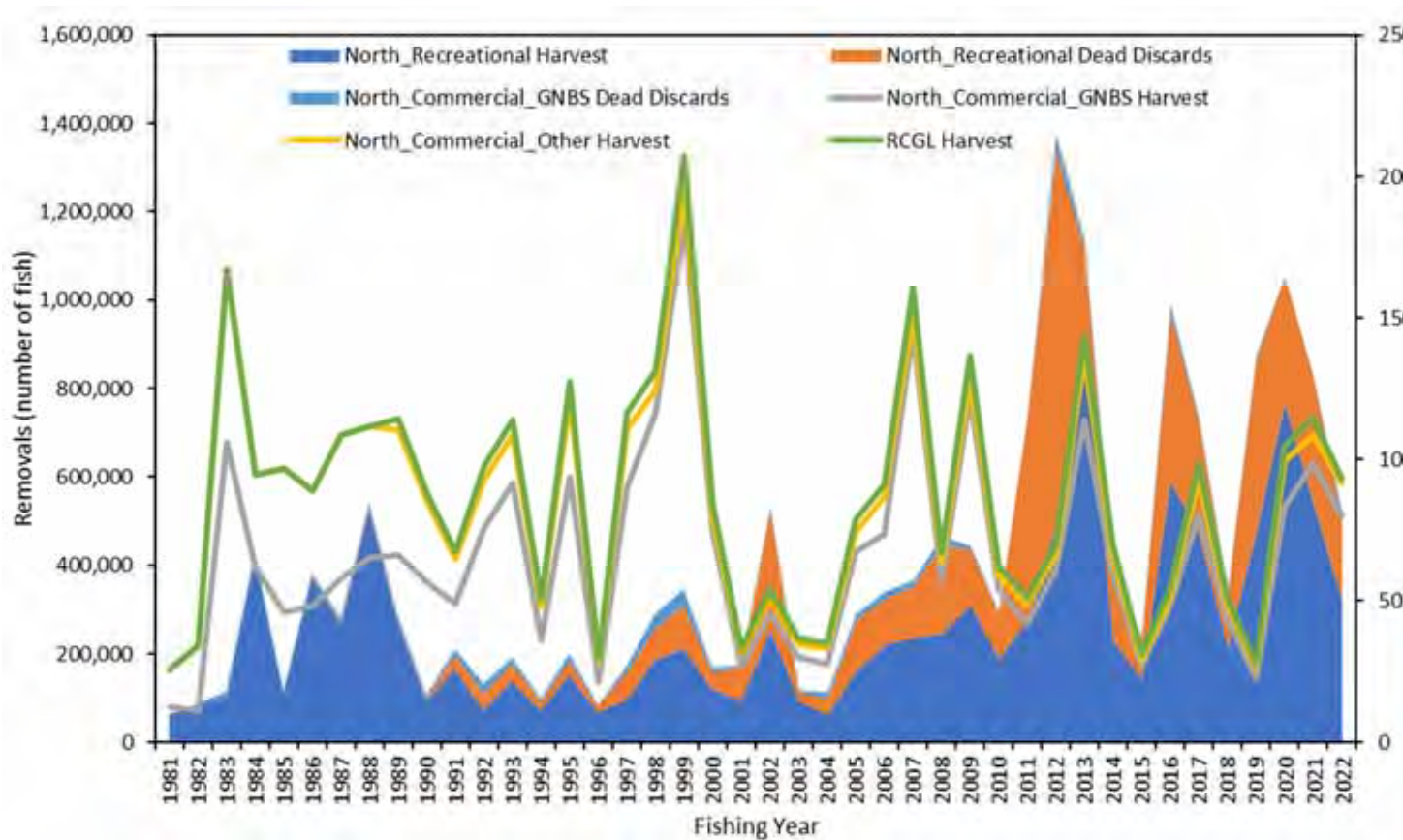


Figure 72. Total fishery removals of northern stock red drum. Stacked area removals are numbers of fish and stacked line removals are metric tons.

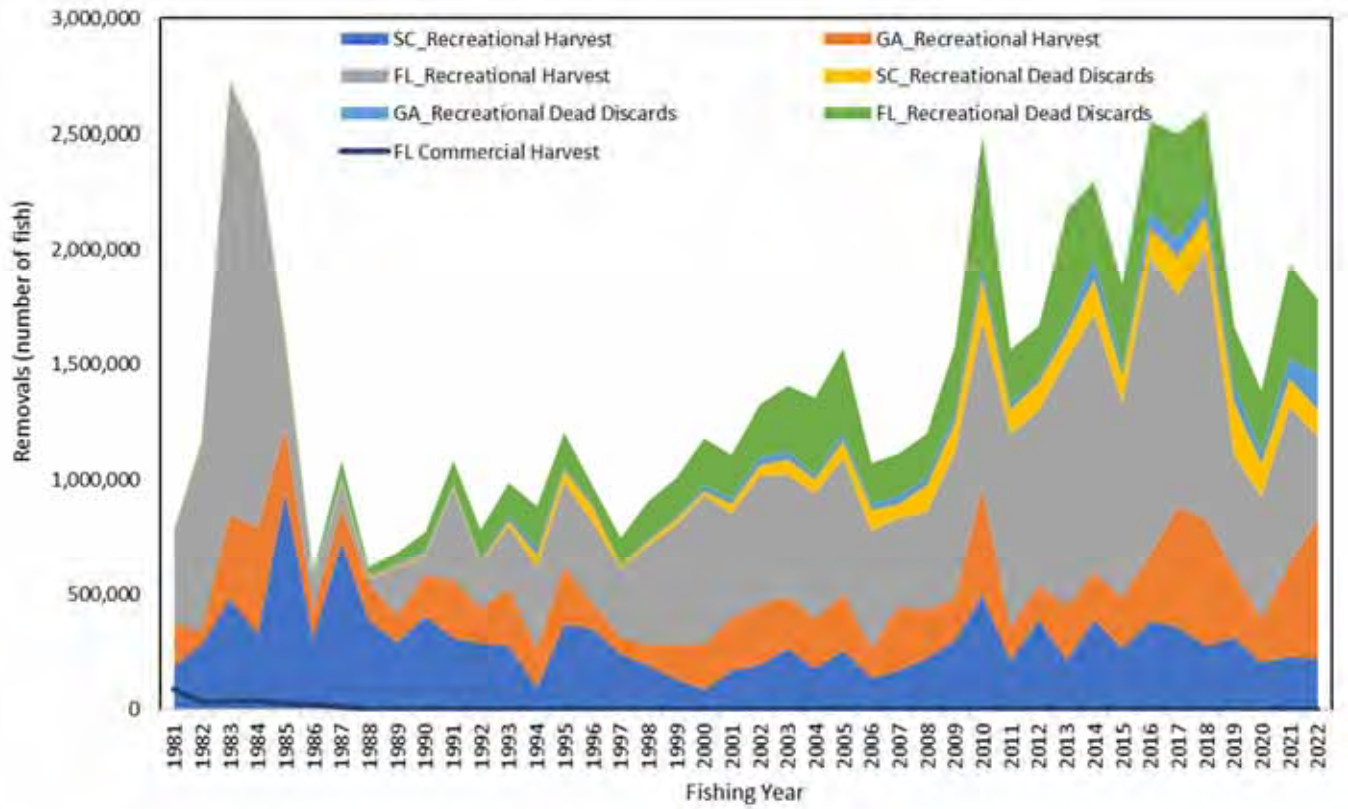


Figure 73. Total fishery removals (stacked area) of southern stock red drum.

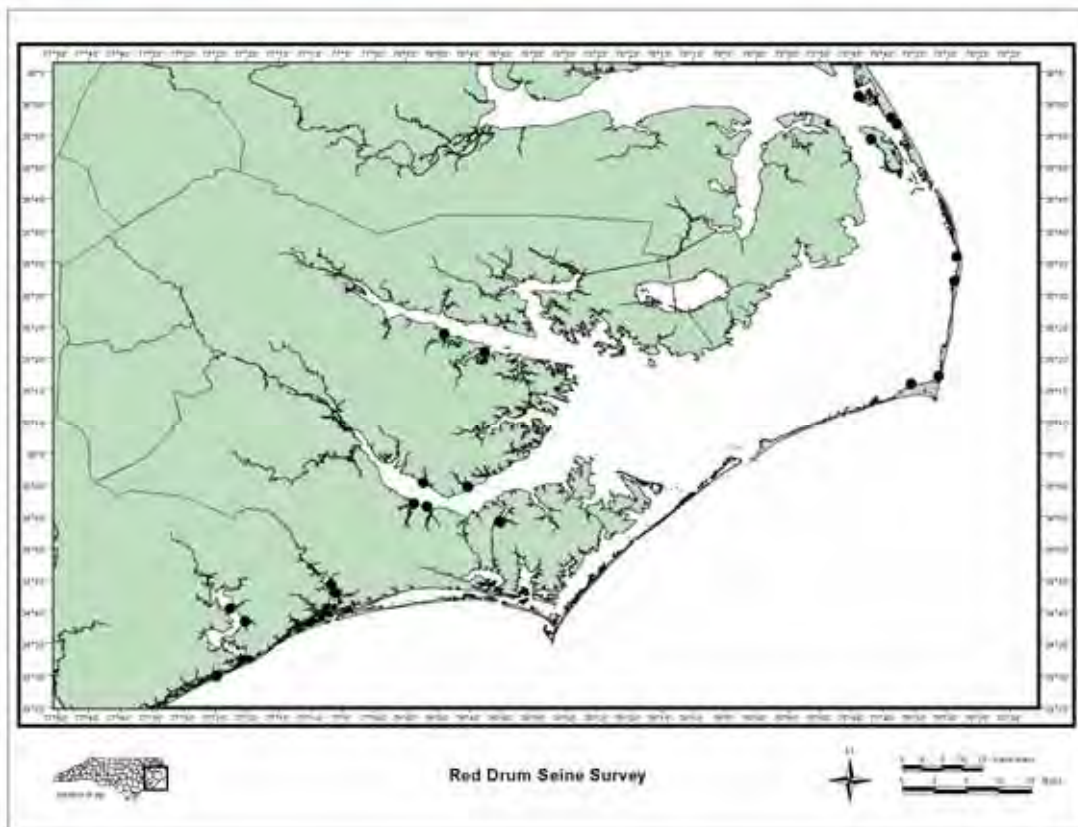
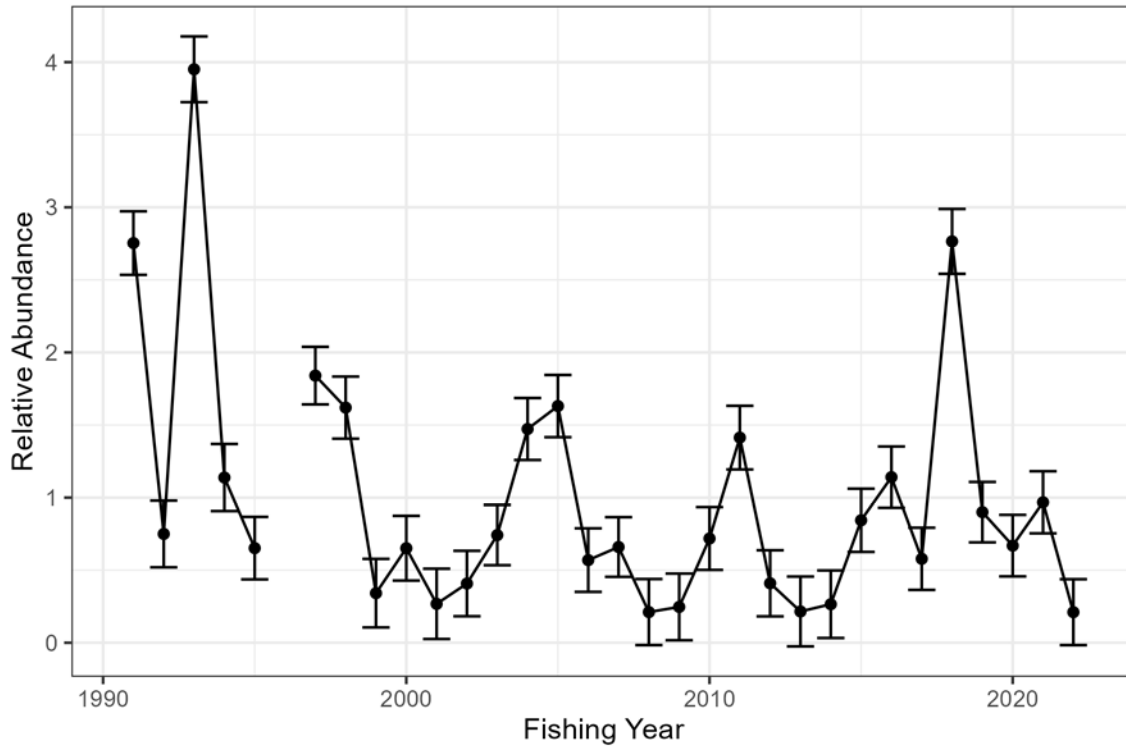
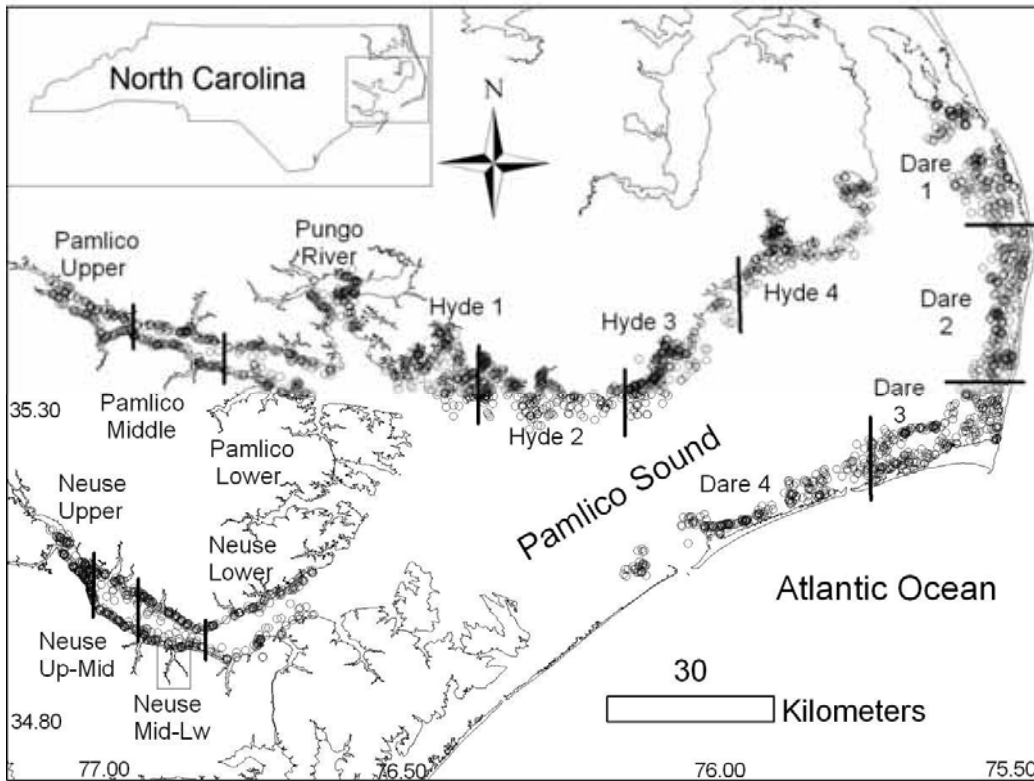


Figure 74. Sampling sites of the North Carolina Bag Seine Survey (NC\_BagSeine)

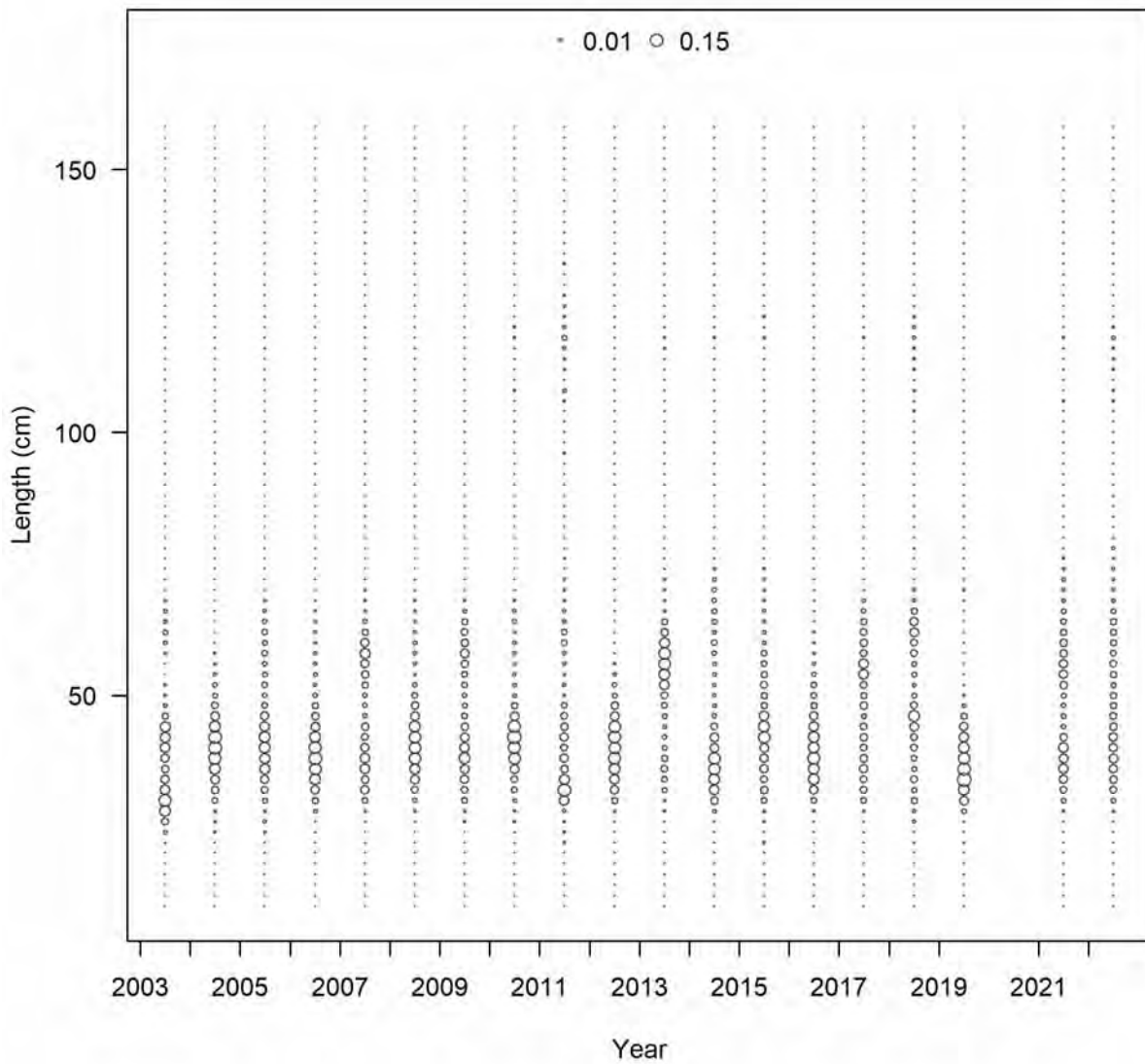




**Figure 75. North Carolina Bag Seine Survey (NC\_BagSeine) relative abundance, standardized to its mean, from 1991-2022. Error bars are  $\pm$  one standard error.**



**Figure 76. Map of Pamlico Sound and associated rivers showing the sample strata and locations of individual samples taken in the North Carolina Independent Gill Net Survey (NC\_GillNet) from 2001 to 2006.**



**Figure 77. Length compositions of red drum captured during the North Carolina Independent Gill Net Survey (NC\_GillNet).**

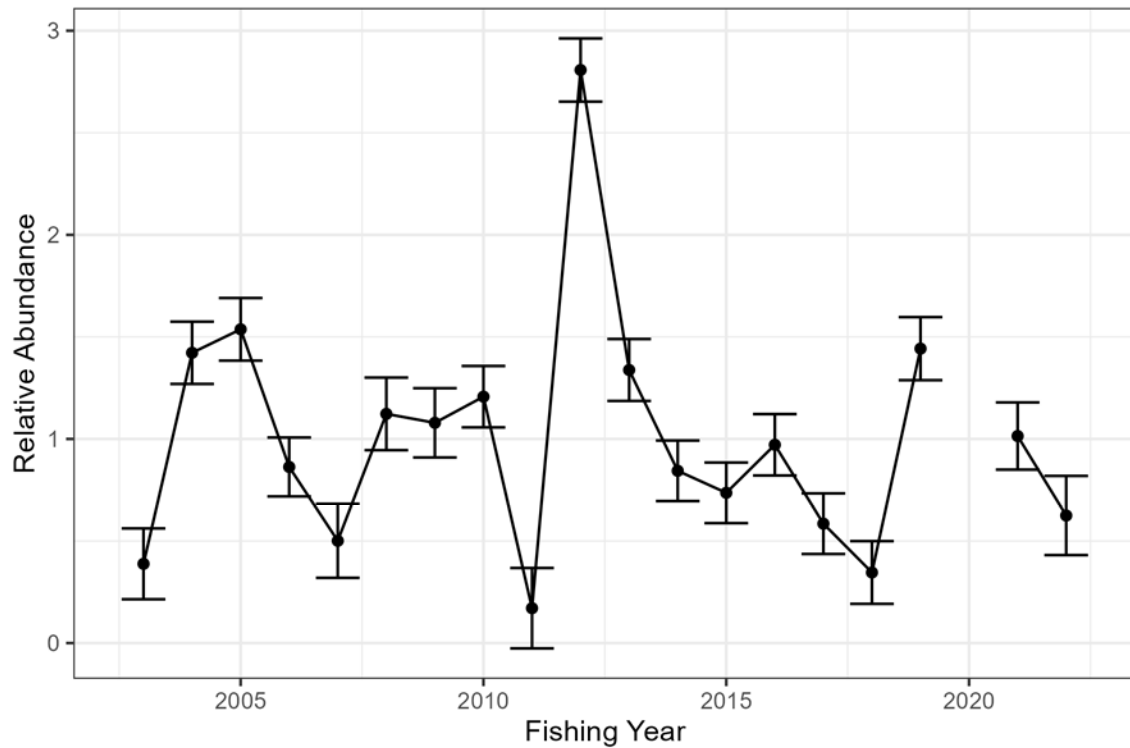


Figure 78. North Carolina Independent Gill Net Survey (NC\_GillNet) relative abundance, standardized to its mean, from 2003-2022. Error bars are  $\pm$  one standard error.

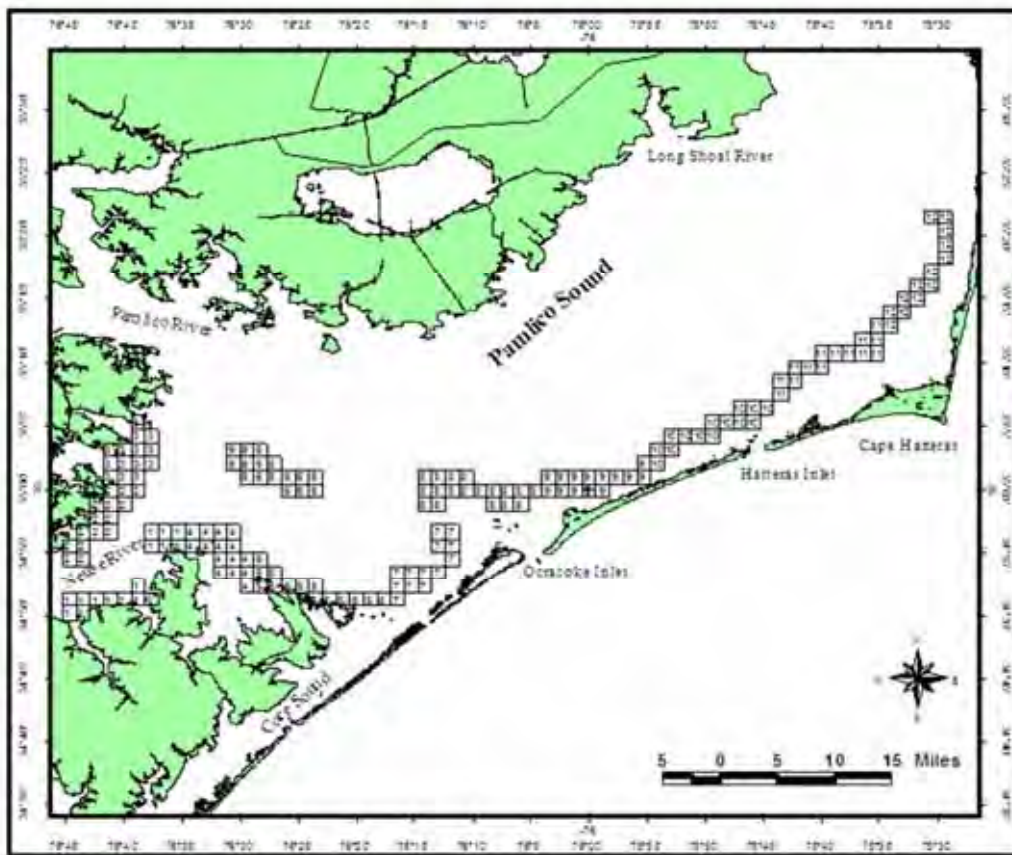
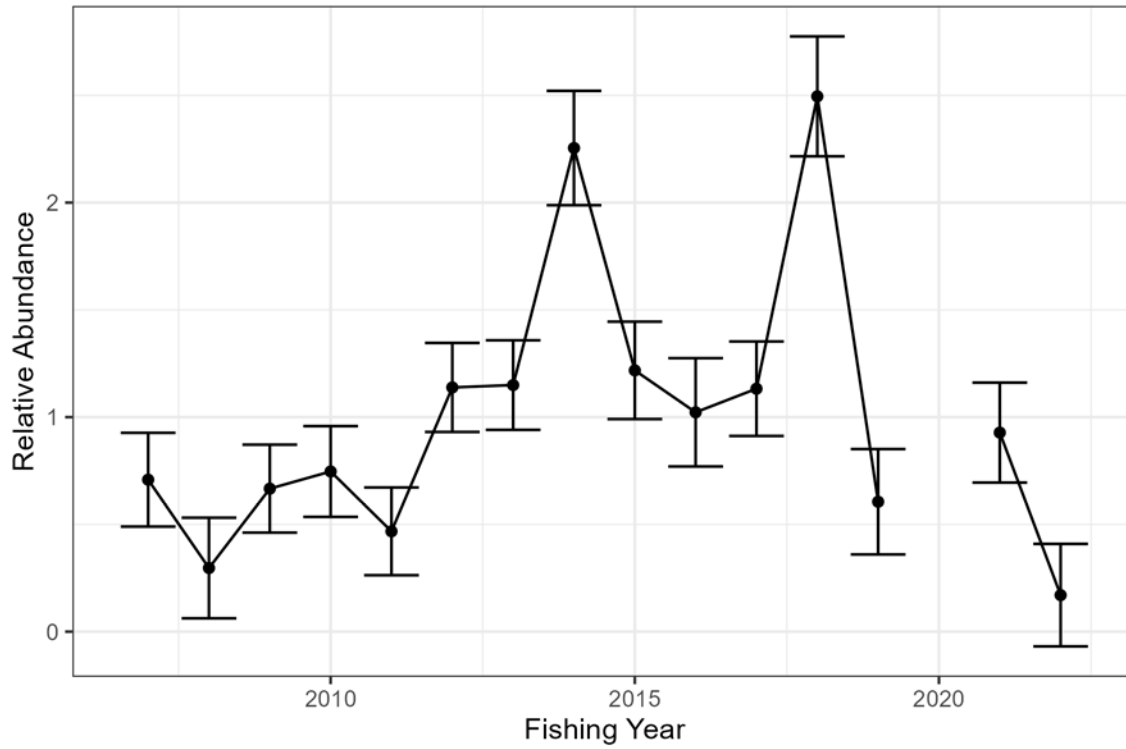
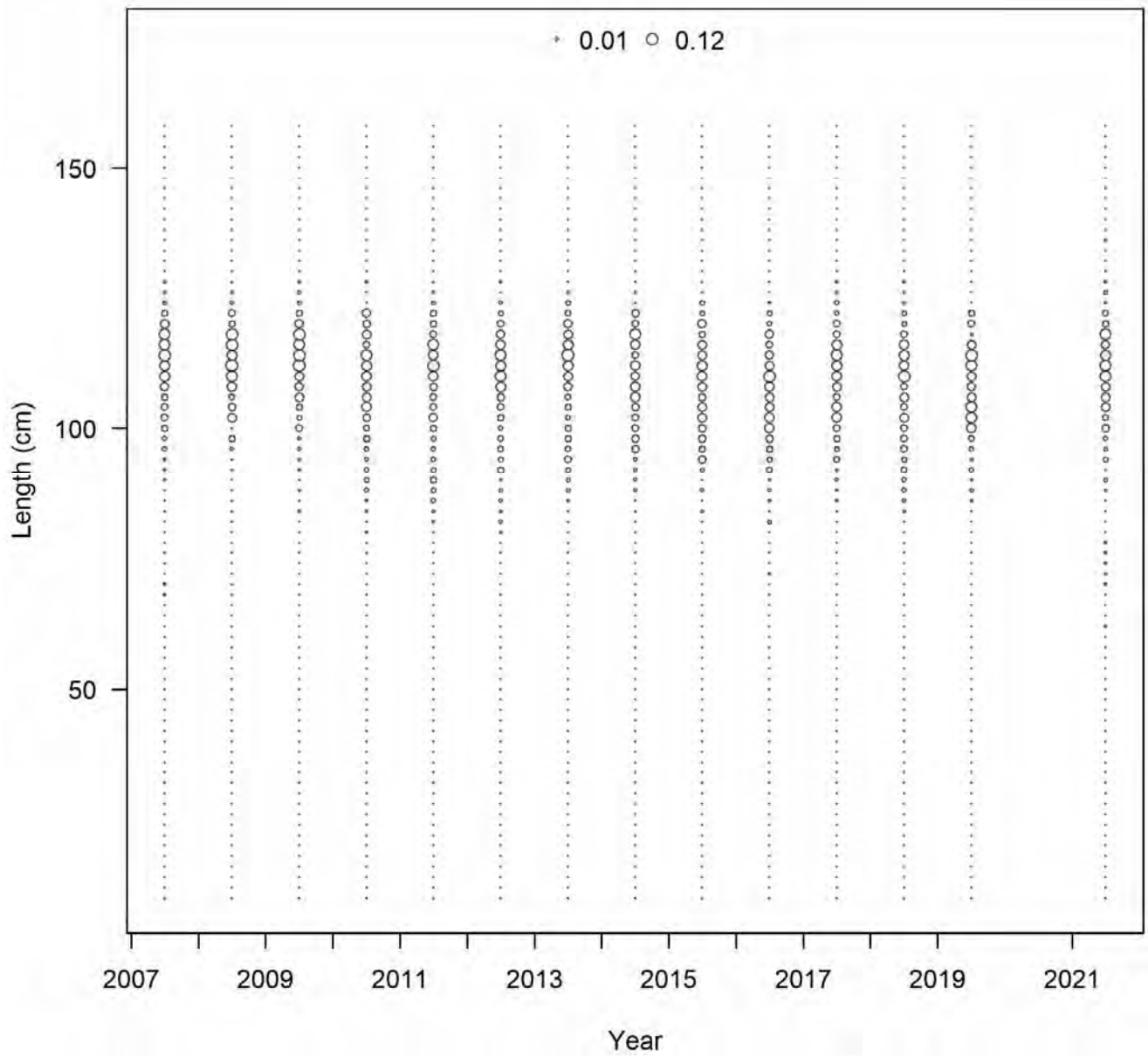


Figure 79. The random grid system and sample regions used in the North Carolina red drum Longline Survey used from 2007 to 2022. The numeric value in each grid designates it to one of the twelve regions sampled.

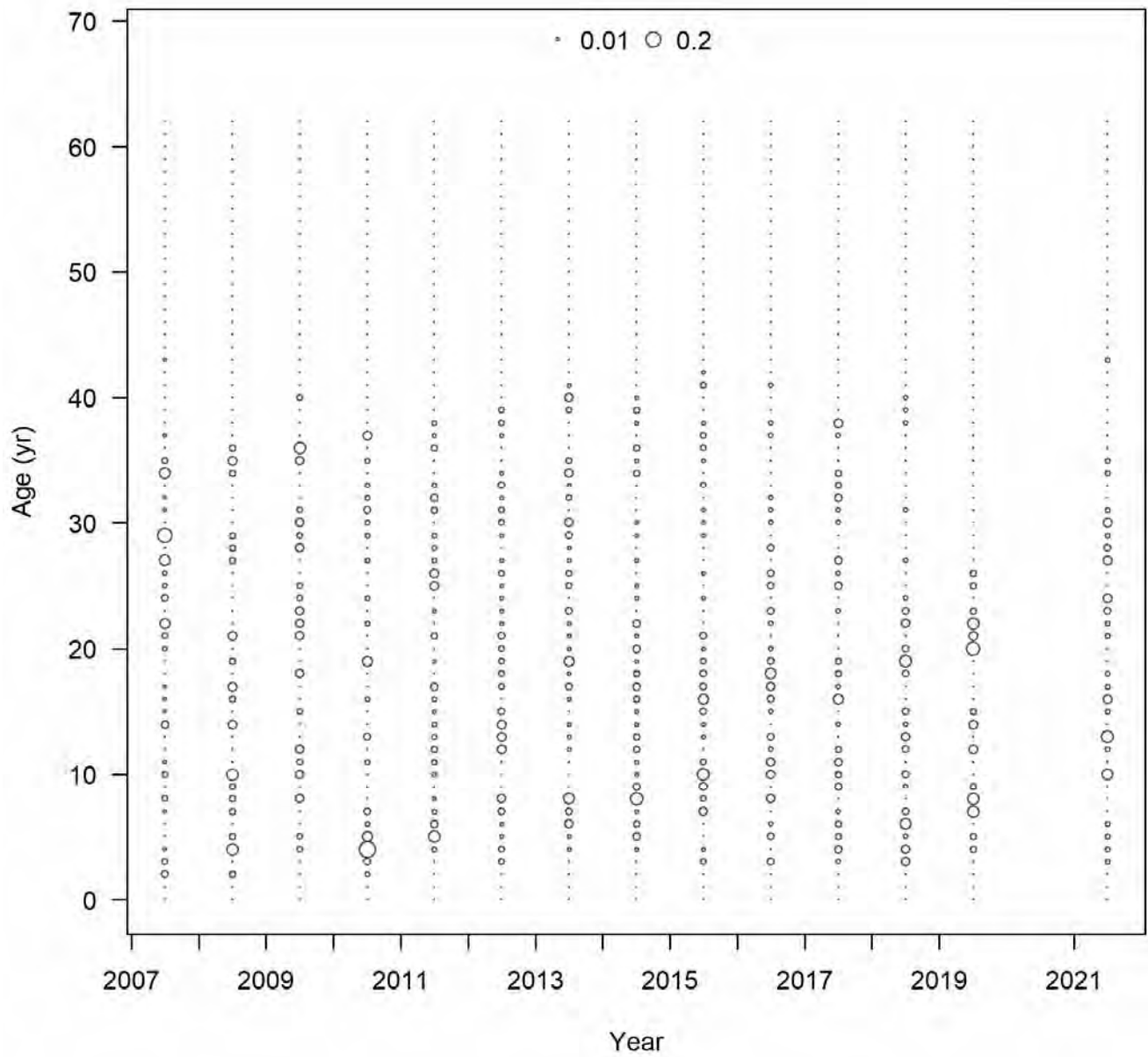


**Figure 80. North Carolina Adult Longline Survey (NC\_Longline) relative abundance, standardized to its mean, from 2007-2022. Error bars are  $\pm$  one standard error.**



**Figure 81. Length compositions of red drum captured during the North Carolina Adult Longline Survey (NC\_Longline).**





**Figure 82. Age distribution of red drum captured during the North Carolina Adult Longline Survey (NC\_Longline).**

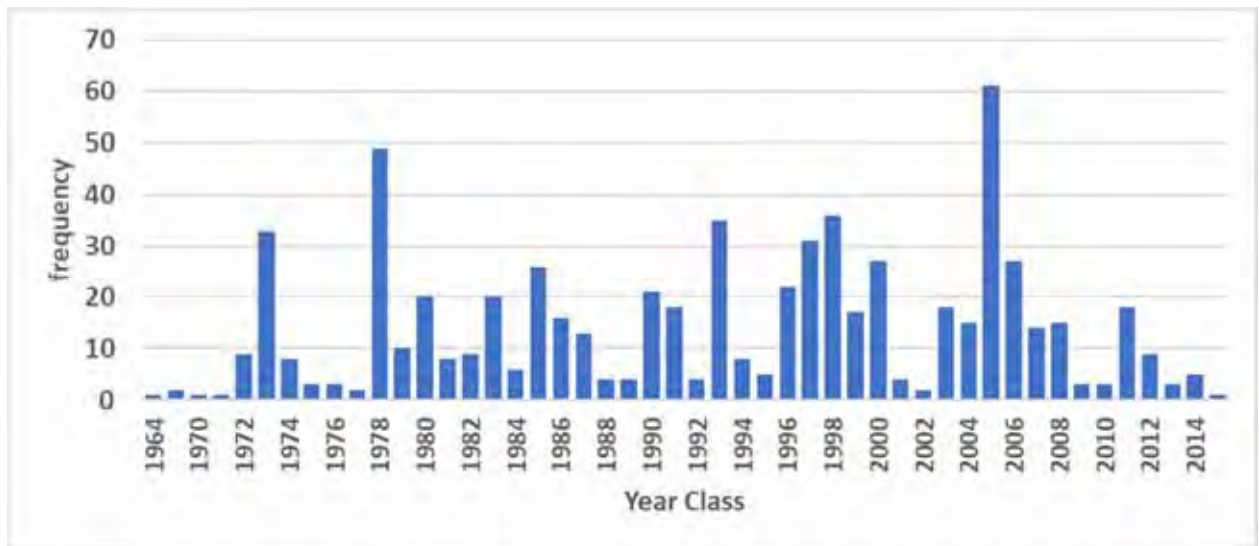


Figure 83. Frequency of individuals by year class (cohort) collected in the North Carolina Adult Longline Survey (NC\_Longline) from 2007 to 2019.

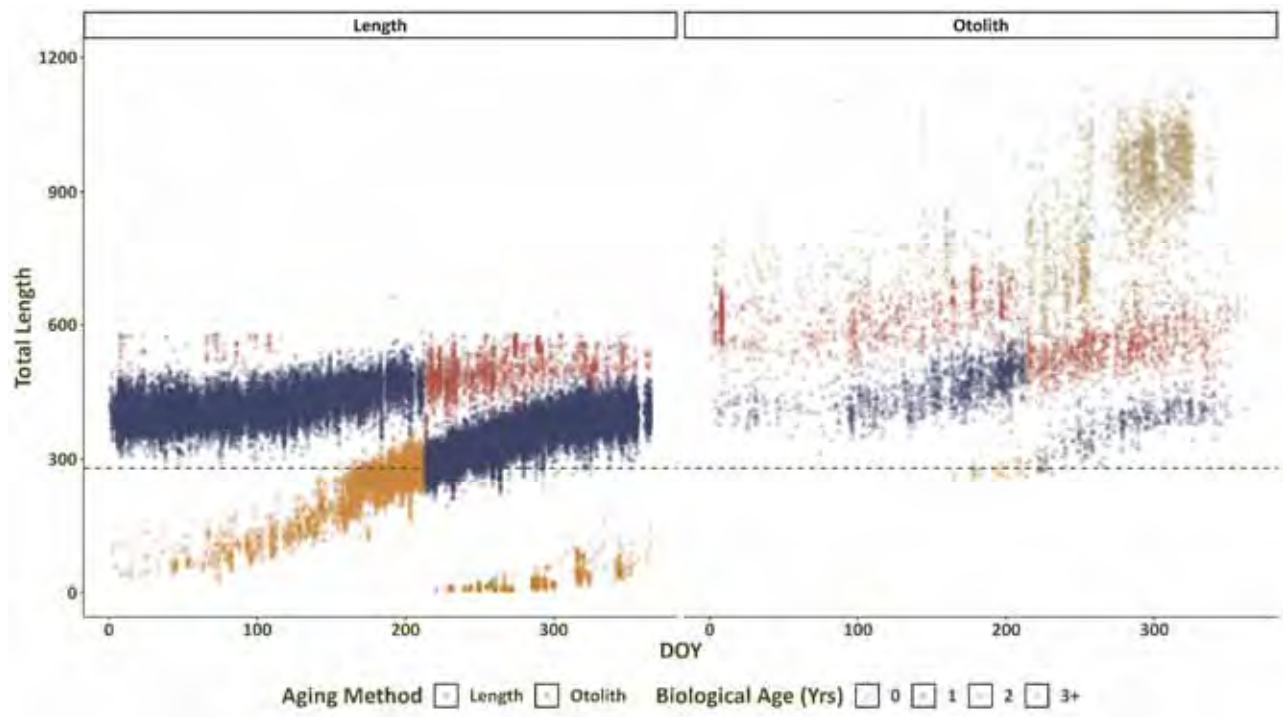


Figure 84. Length distribution, based on calendar year (Jan. 1 – Dec. 31), ageing methodology, and day of year of sampling, of red drum encountered by the SCDNR fishery-independent and fishery-dependent sampling programs. Ages are based on biological age, assuming a September 1 birthday. Note, any fish with age determined using scales have been omitted.

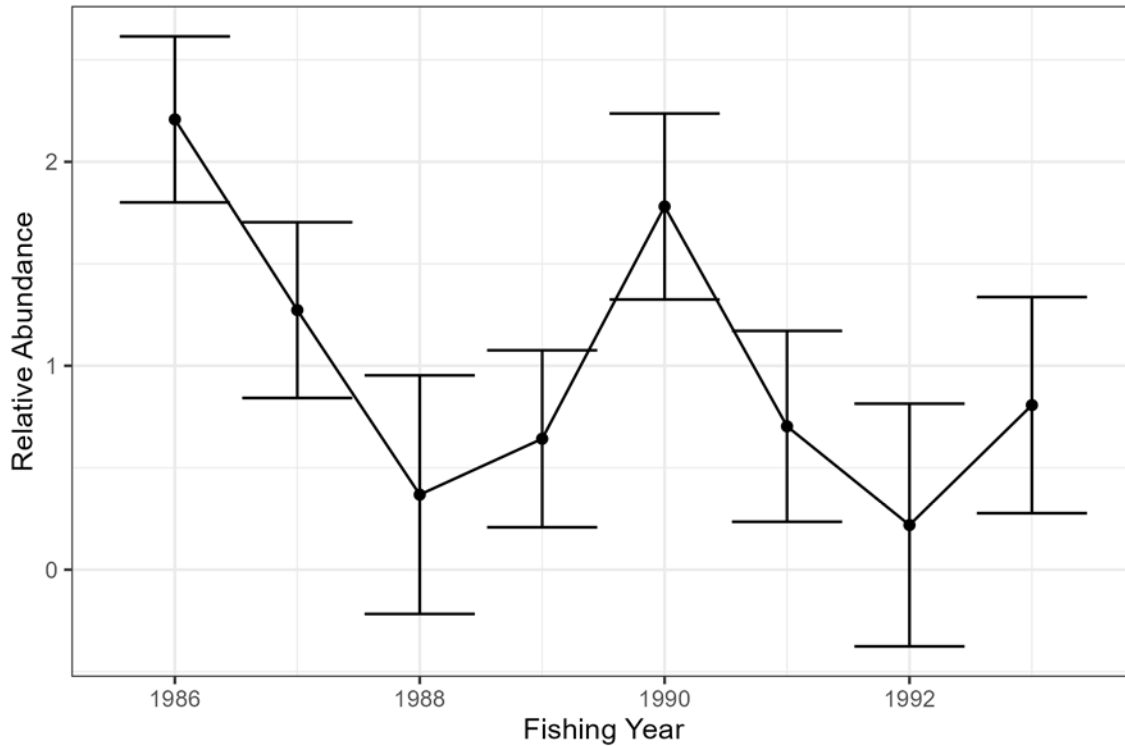


Figure 85. South Carolina Rotenone Survey (SC\_Rotenone) relative abundance, standardized to its mean, from 1986-1993. Error bars are  $\pm$  one standard error.

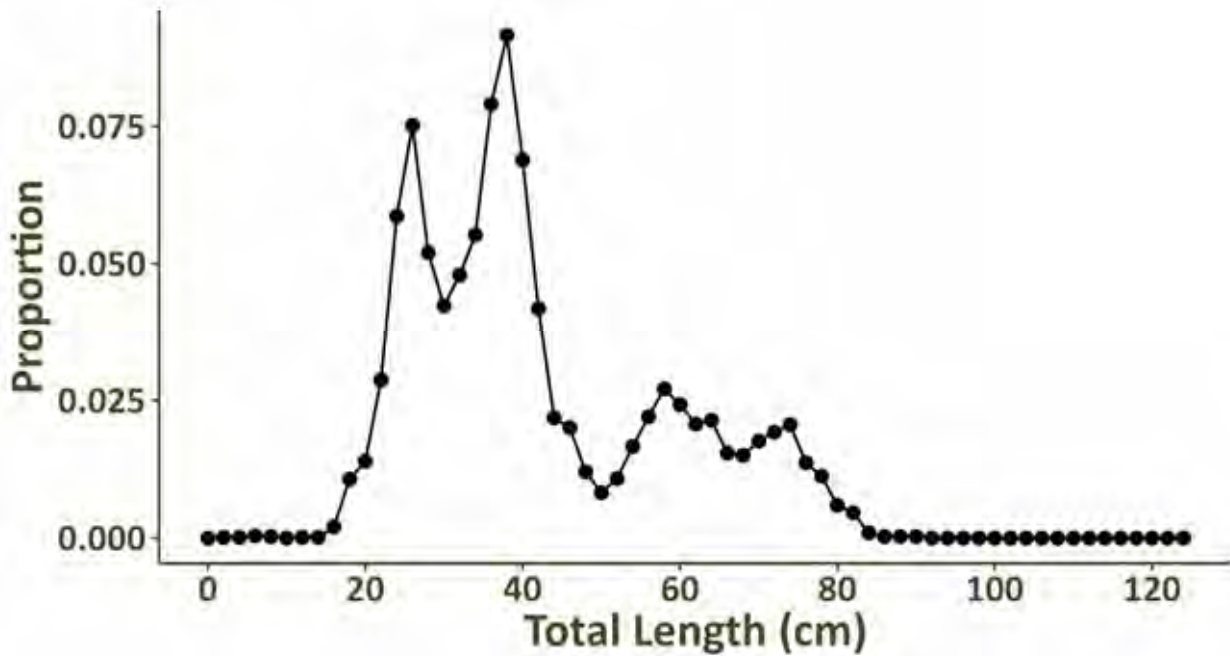


Figure 86. Length composition of red drum encountered by the South Carolina Stop Net Survey (SC\_StopNet) when pooled across all years.

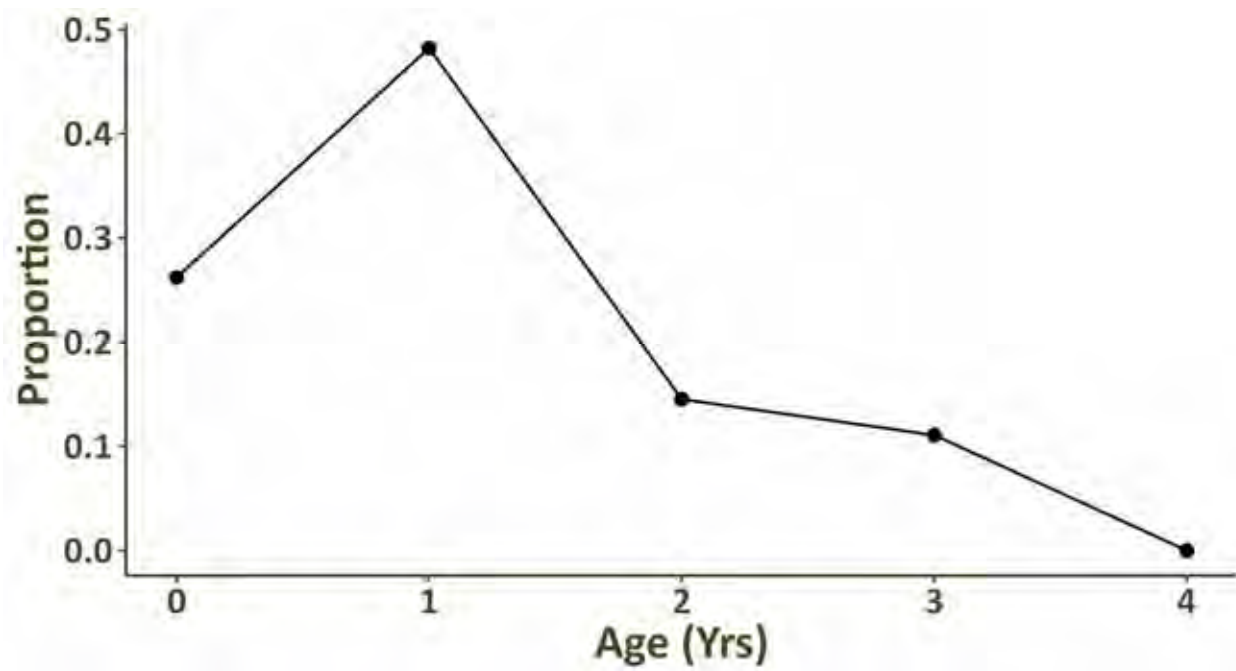


Figure 87. Age composition of red drum encountered by the South Carolina Stop Net Survey (SC\_StopNet) when pooled across all years. Age 4 represents an age-4+ group.

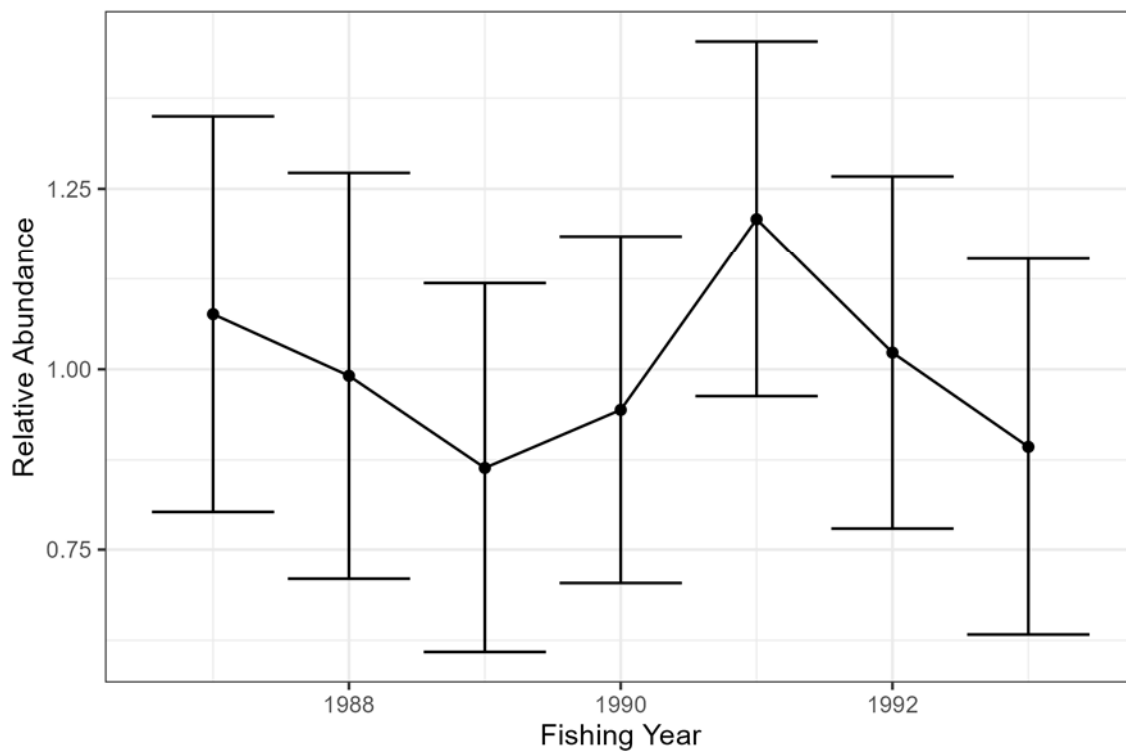
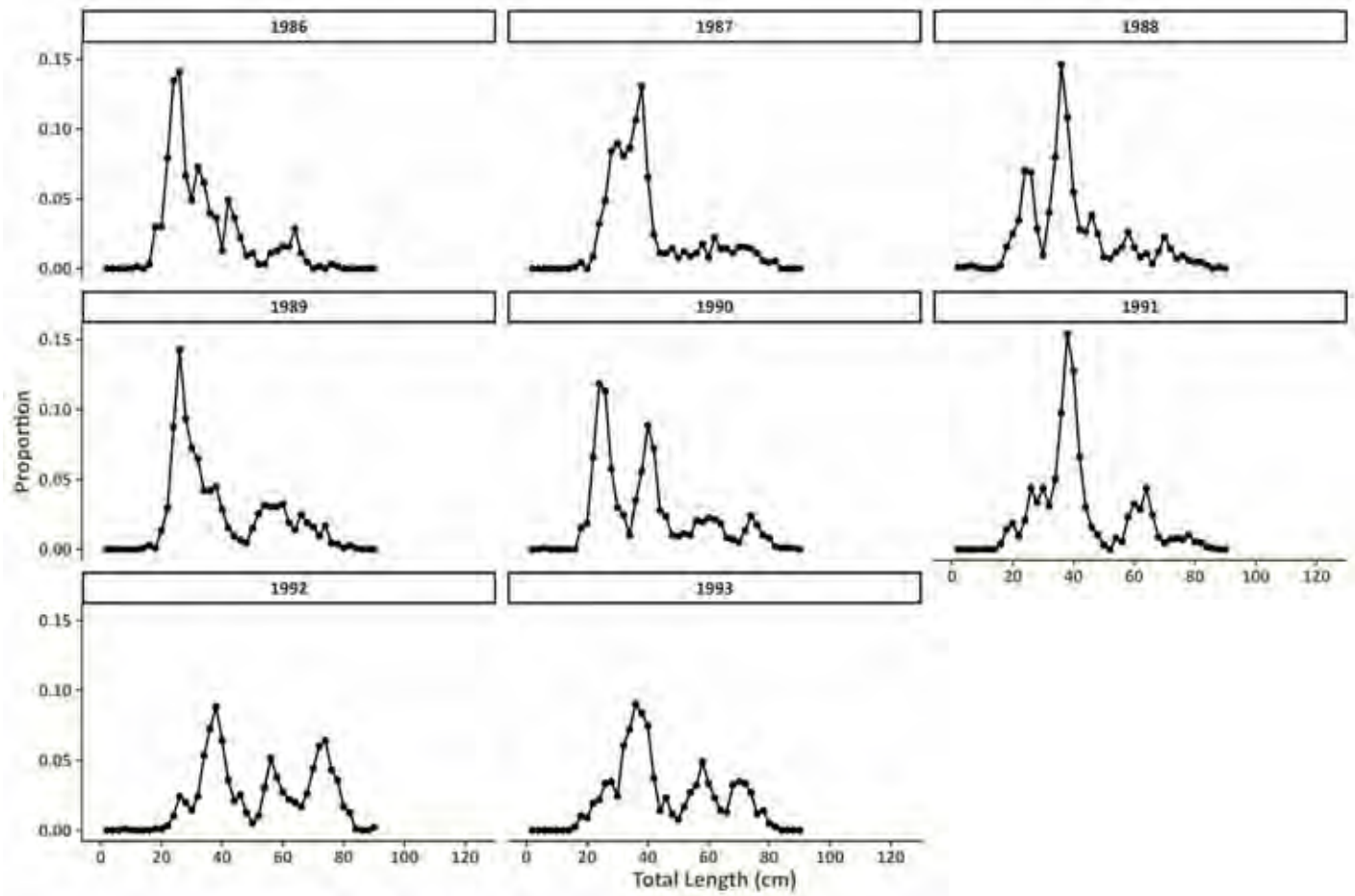
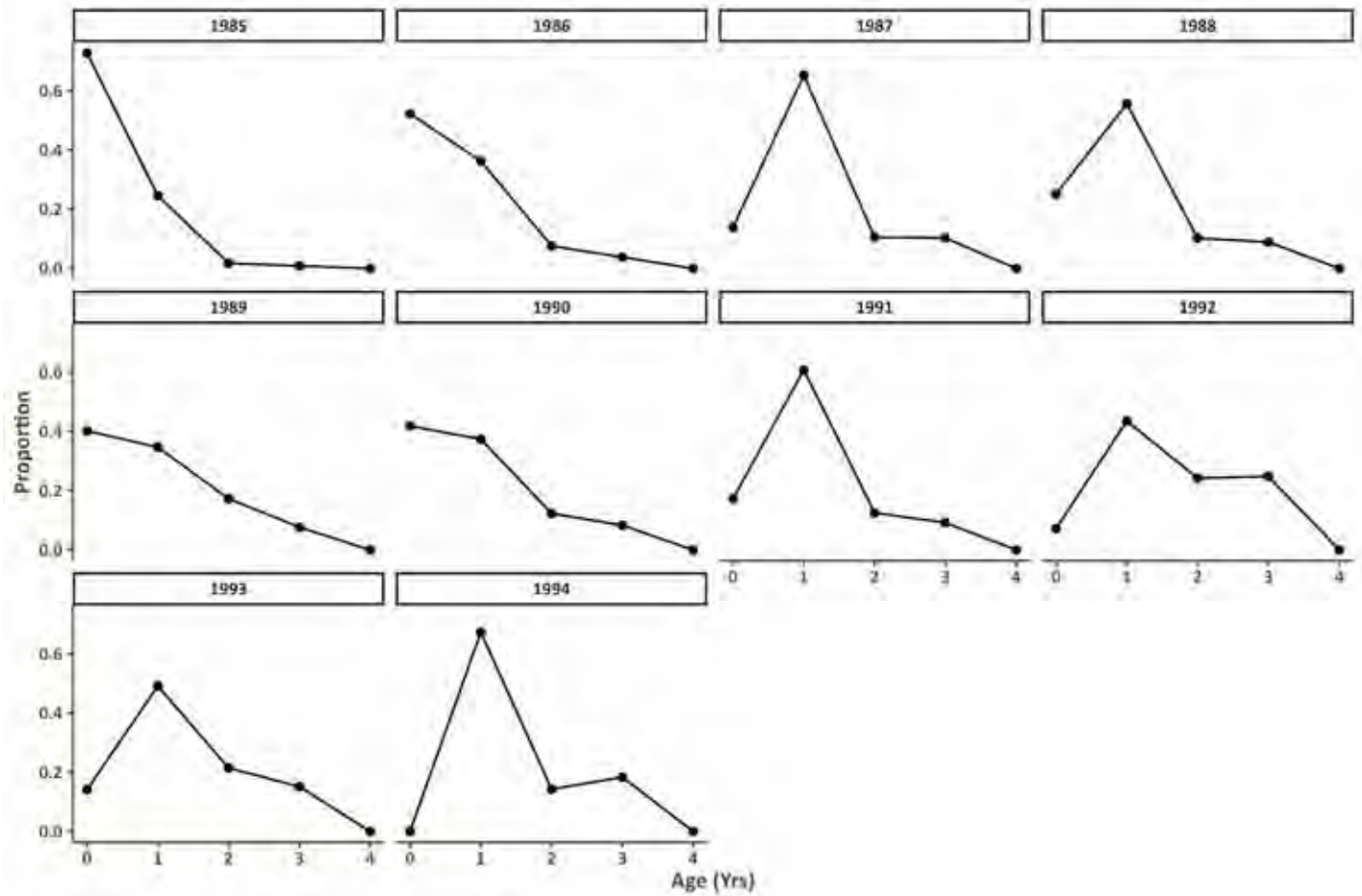


Figure 88. South Carolina Stop Net Survey (SC\_StopNet) relative abundance, standardized to its mean, from 1987-1993. Error bars are  $\pm$  one standard error.



**Figure 89. Annual length compositions developed for the South Carolina Stop Net Survey (SC\_StopNet).**



**Figure 90. Annual age compositions developed for the South Carolina Stop Net Survey (SC\_StopNet). Note, age represents biological age assuming a September 1 birthday and age-4 represents a 'plus' group.**

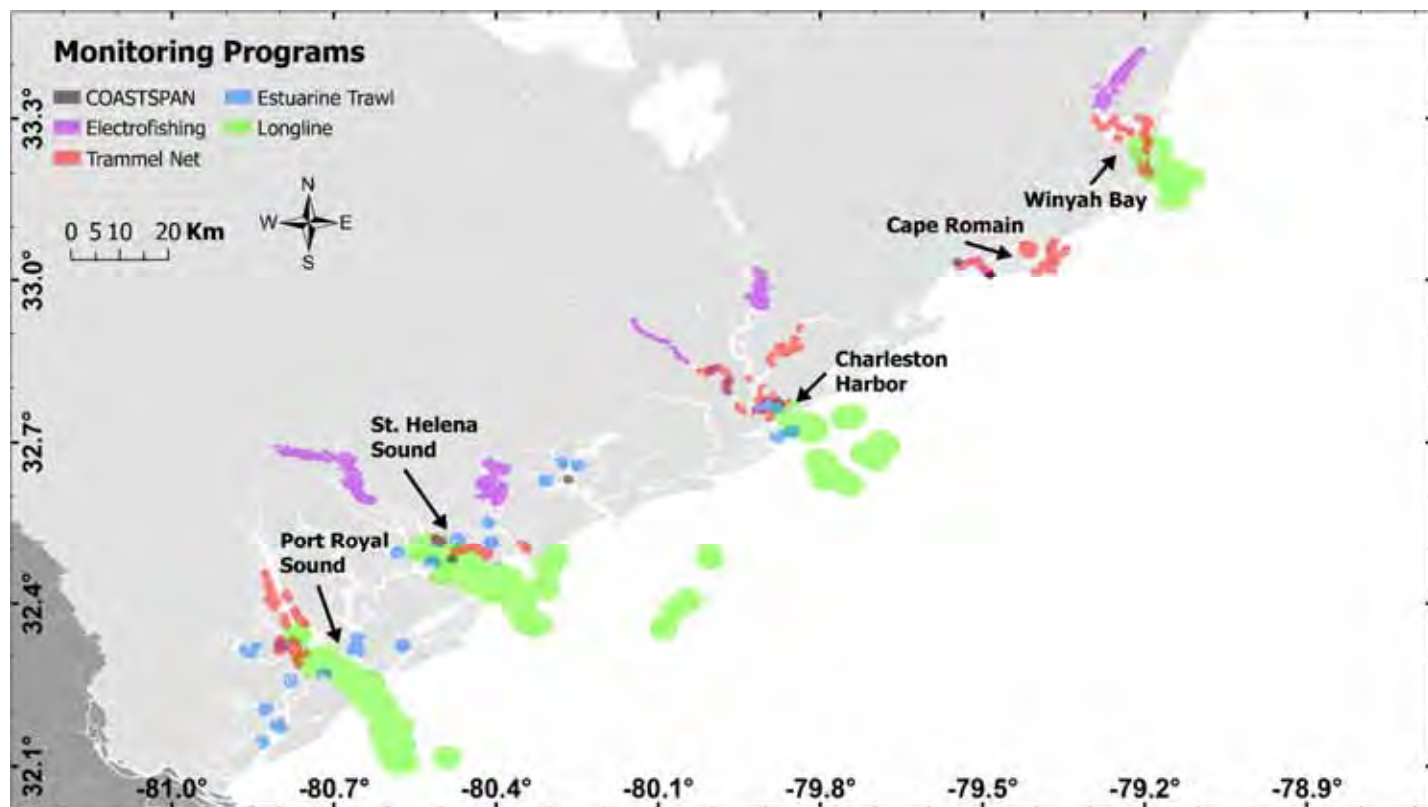


Figure 91. Sampling distribution of the South Carolina Trammel Net Survey (SC\_Trammel; red shaded areas), South Carolina Electrofishing Survey (SC\_Electro; purple shaded areas) and South Carolina Contemporary Longline Survey (SC\_Longline\_contemporary; green shaded areas) surveys. Also identified are two additional contemporary fishery-independent finfish surveys that do not regularly encounter red drum, SCDNR's COASTSPAN (gray shaded areas) and estuarine trawl (blue shaded areas) surveys. Identified are the five major South Carolina estuaries, from Port Royal Sound in the south to Winyah Bay in the north.



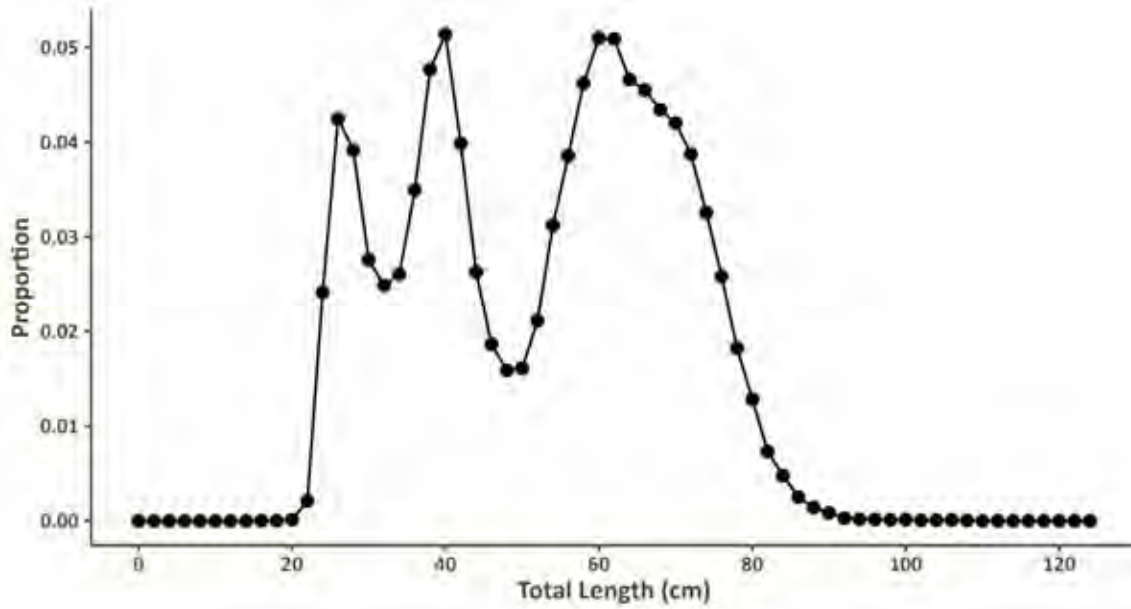


Figure 92. Length composition of red drum encountered by the South Carolina Trammel Net Survey (SC\_Trammel) when pooled across all years.

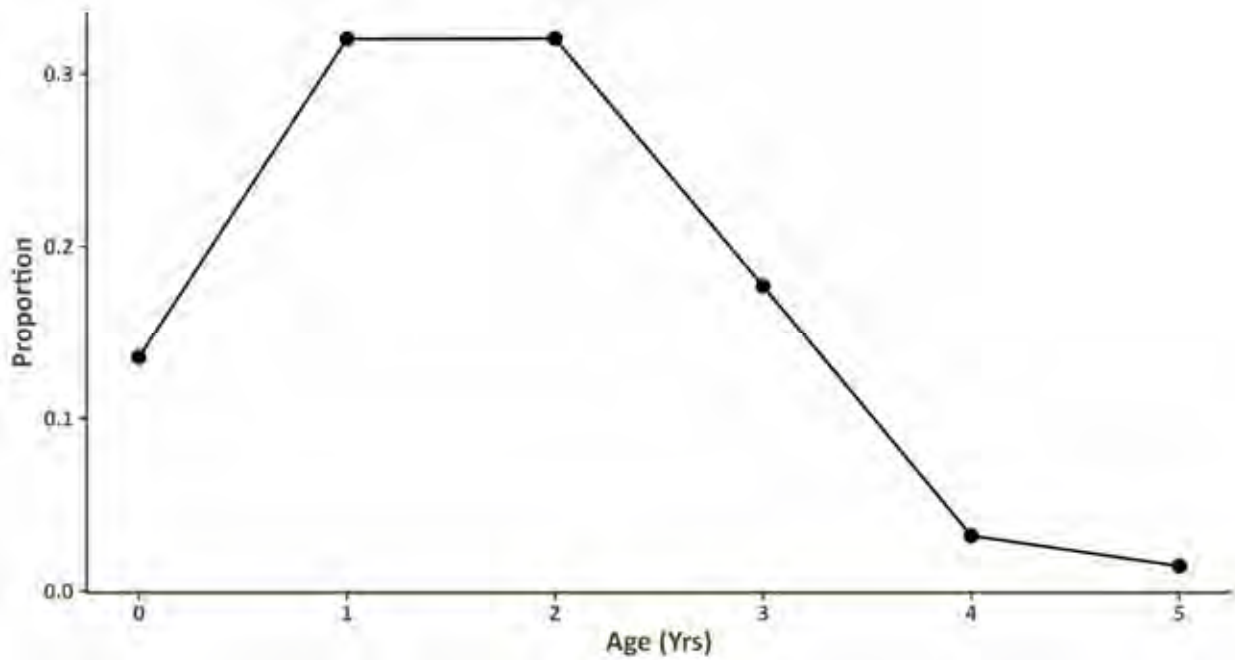
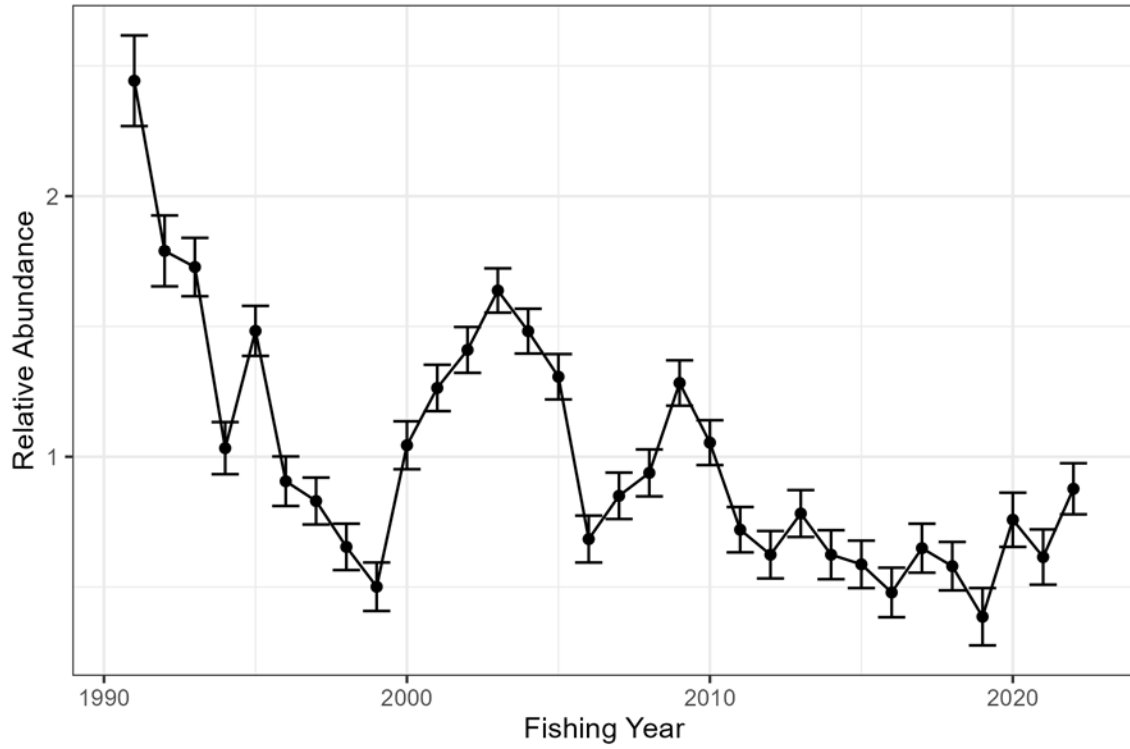


Figure 93. Age composition of red drum encountered by the South Carolina Trammel Net Survey (SC\_Trammel) when pooled across all years. Age 5 represents an age 5+ group.





**Figure 94. South Carolina Trammel Net Survey (SC\_Trammel) relative abundance, standardized to its mean, from 1991-2022. Error bars are  $\pm$  one standard error.**

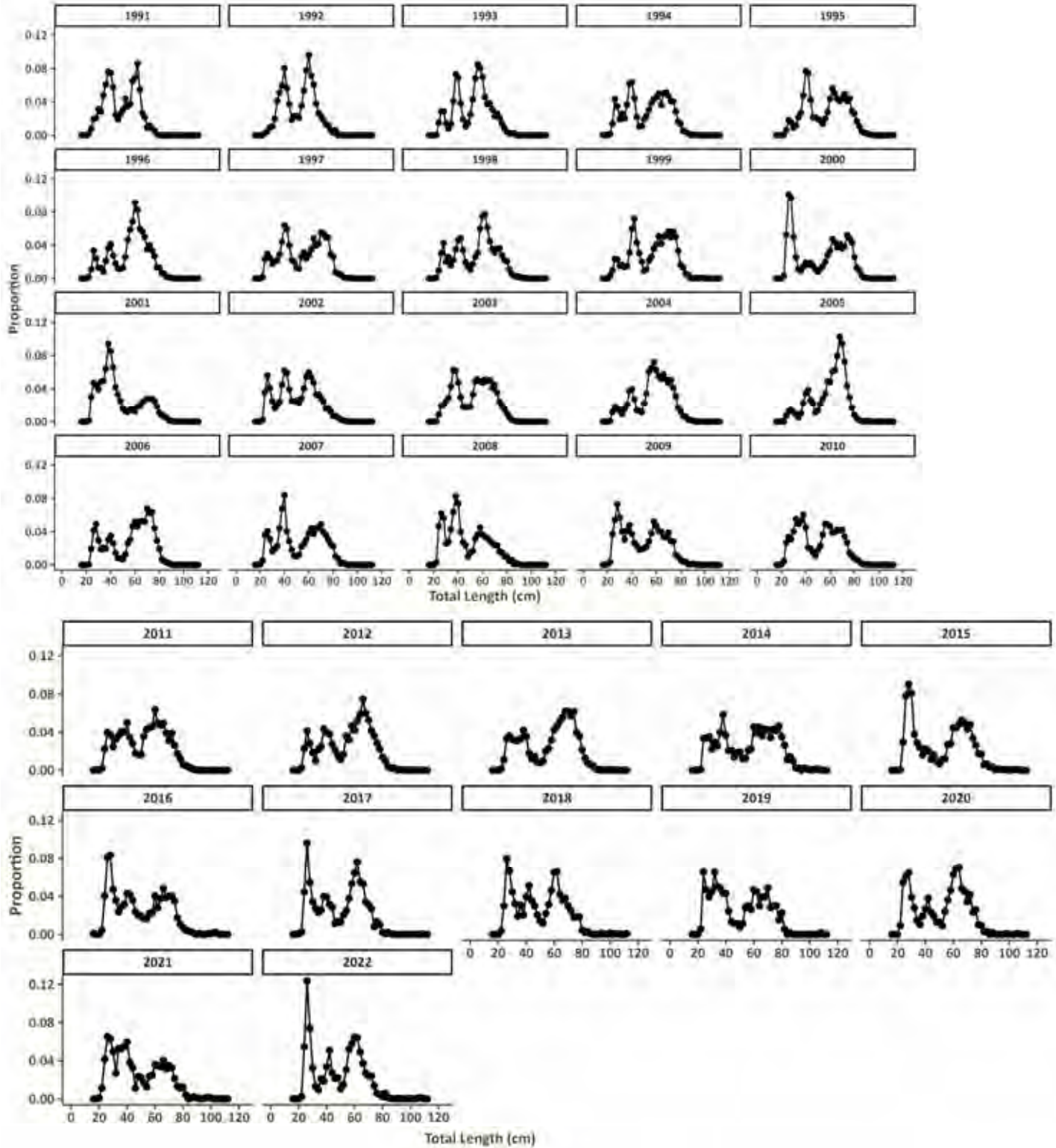
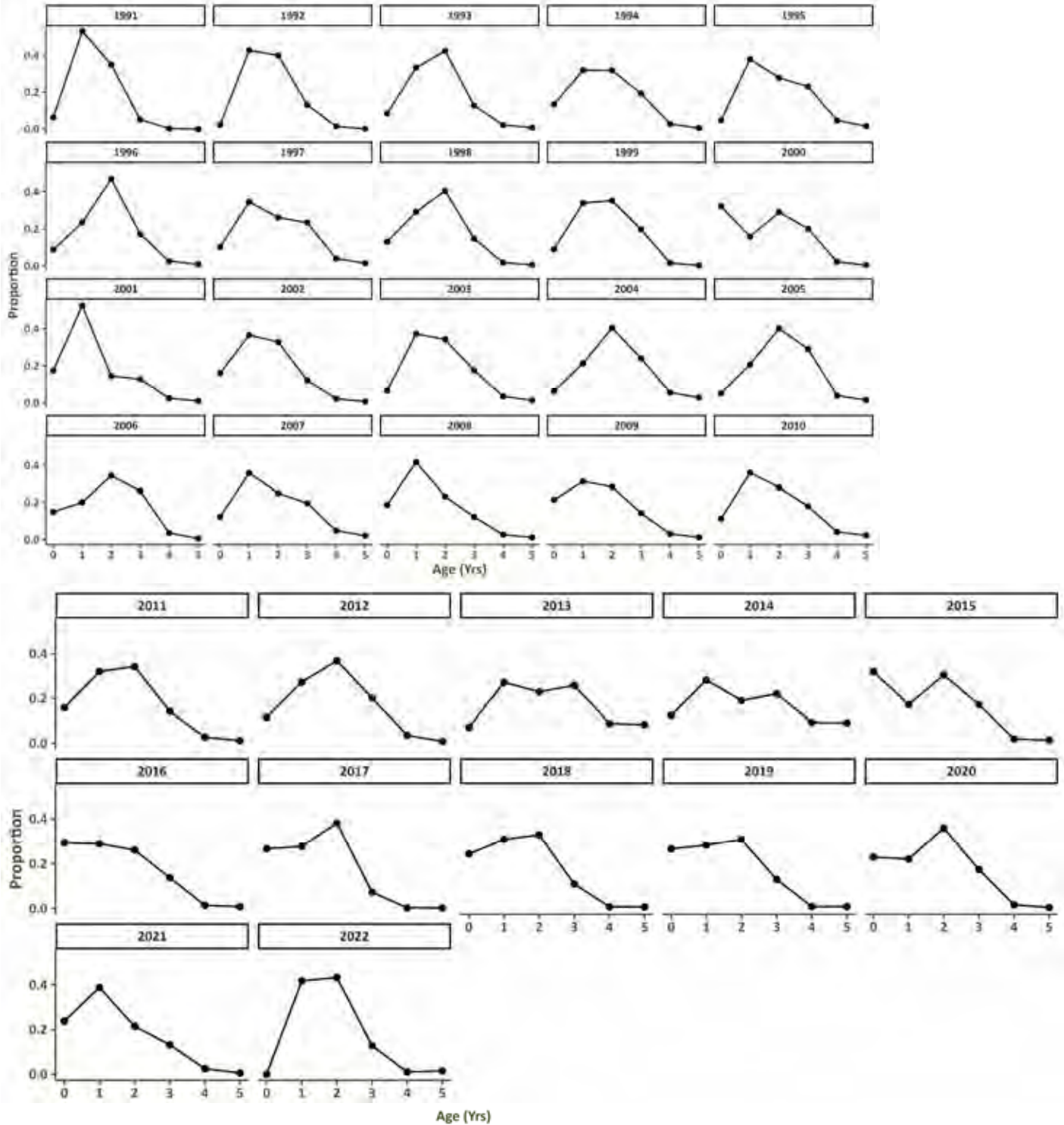
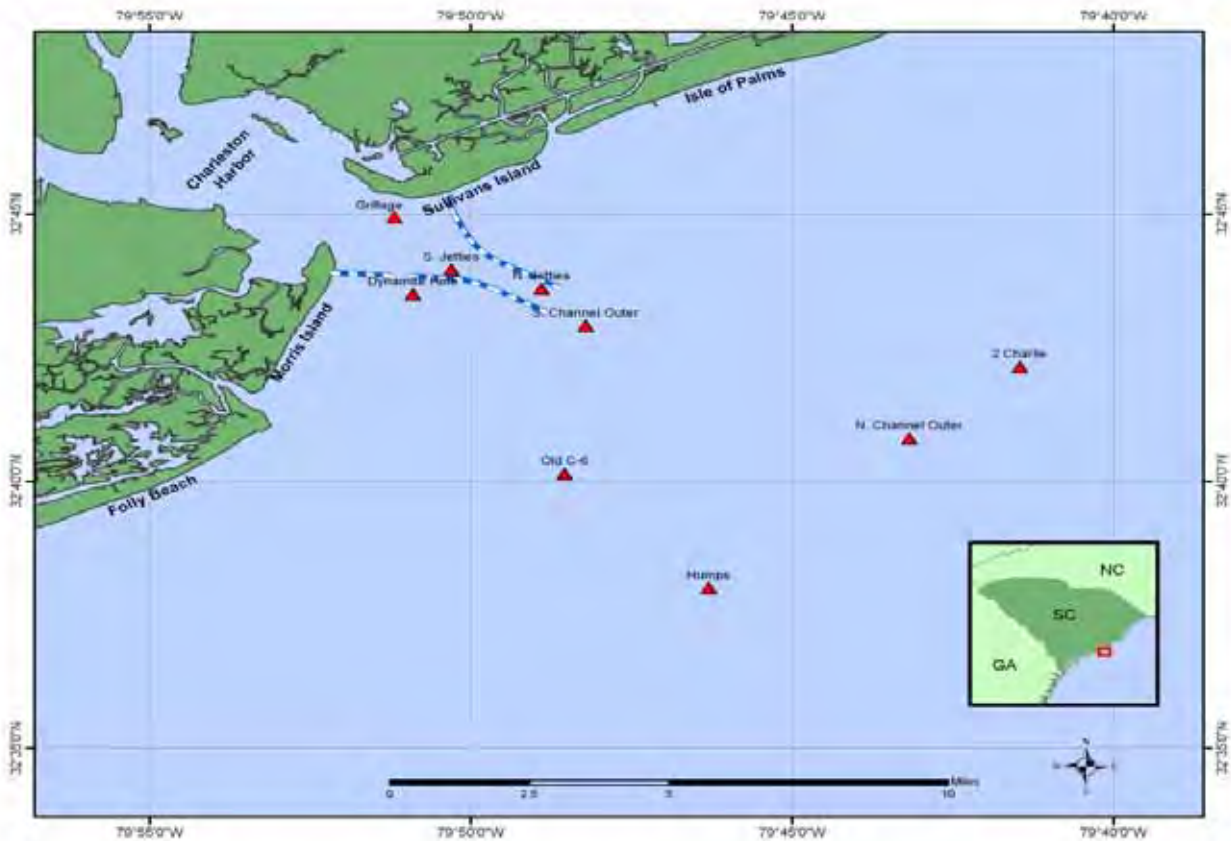


Figure 95. Annual length compositions developed for the South Carolina Trammel Net Survey (SC\_Trammel).



**Figure 96. Annual age compositions developed for the South Carolina Trammel Net Survey (SC\_Trammel). Note, age represents biological age assuming a September 1 birthday and age-5 represents a 'plus' group.**



**Figure 97. Fixed stations sampled as part of the South Carolina Historic Longline Survey (SC\_Longline\_historic) conducted by the SCDNR from 1994-2006 near Charleston, SC. The five fixed stations considered for index development are outlined by red circles.**

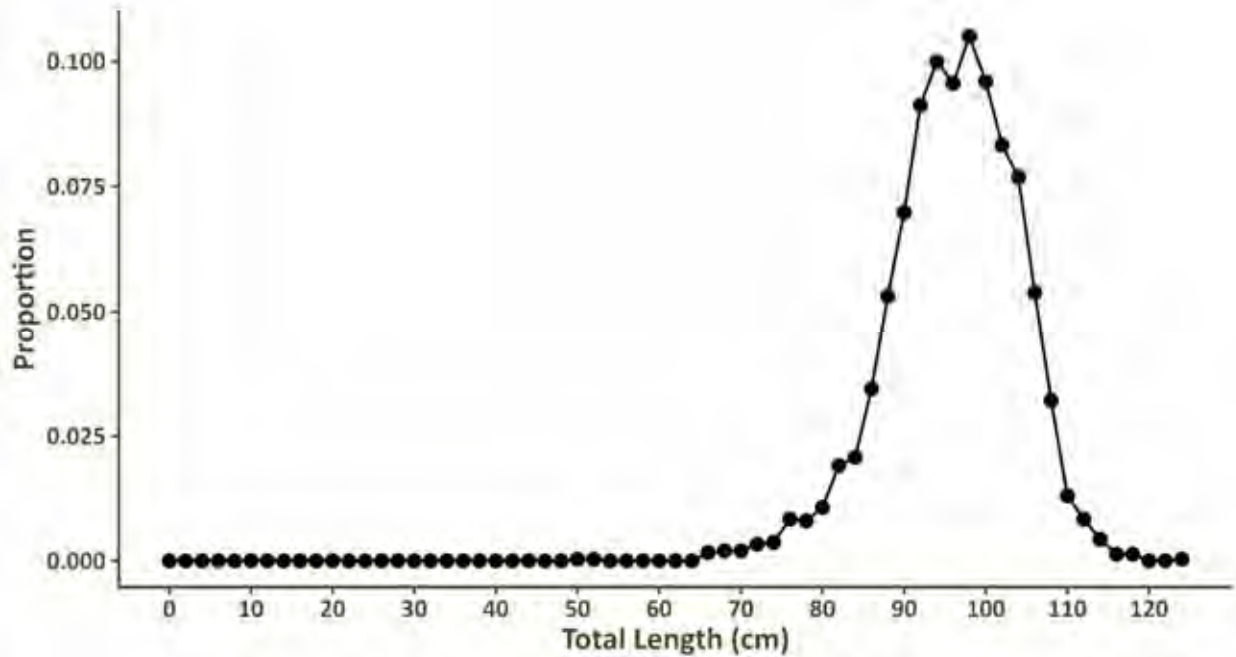


Figure 98. Length composition of red drum encountered by the South Carolina Historic Longline Survey (SC\_Longline\_historic) when pooled across all years.

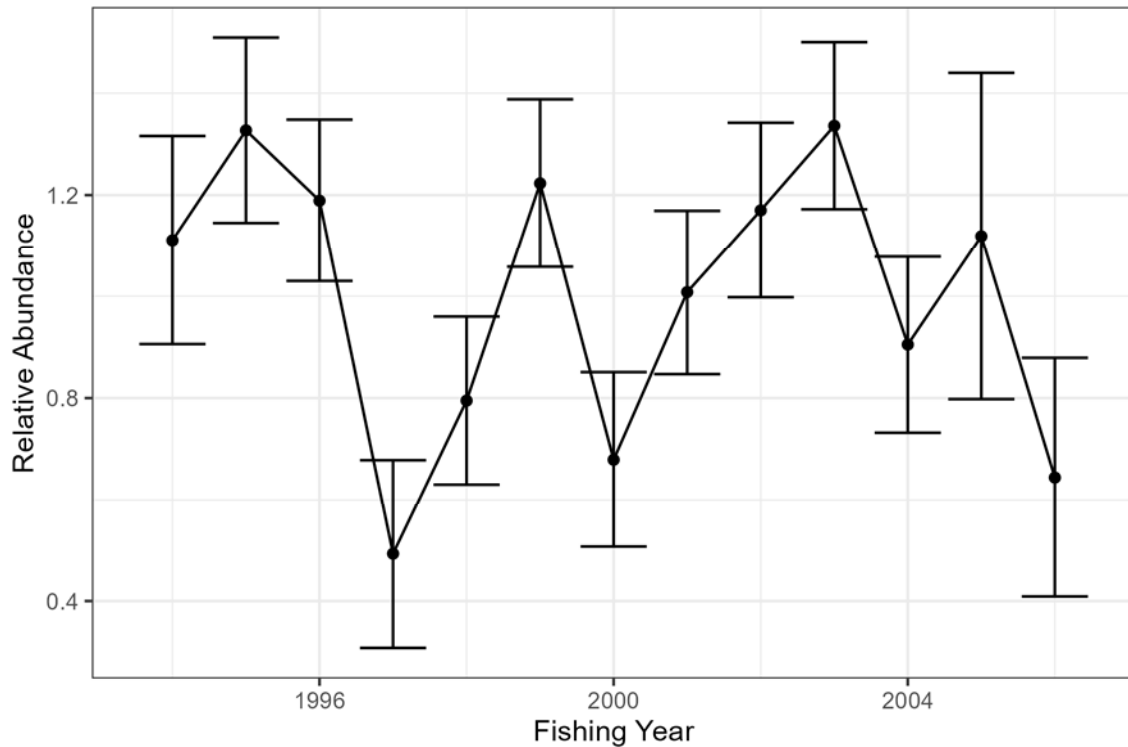


Figure 99. South Carolina Historic Longline Survey (SC\_Longline\_historic) relative abundance, standardized to its mean, from 1994-2006. Error bars are  $\pm$  one standard error.

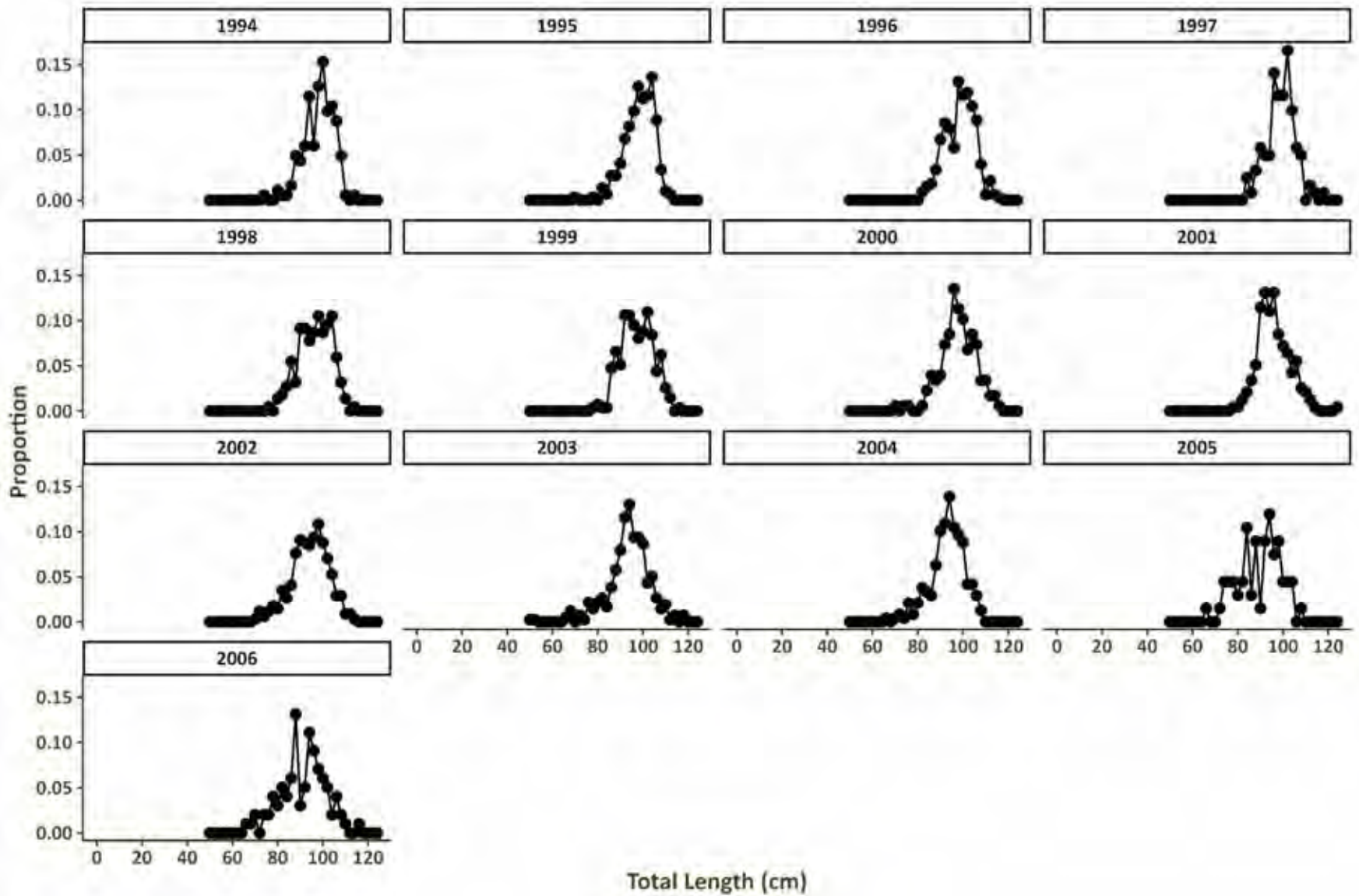


Figure 100. Annual length compositions developed for the South Carolina Historic Longline Survey (SC\_Longline\_historic)



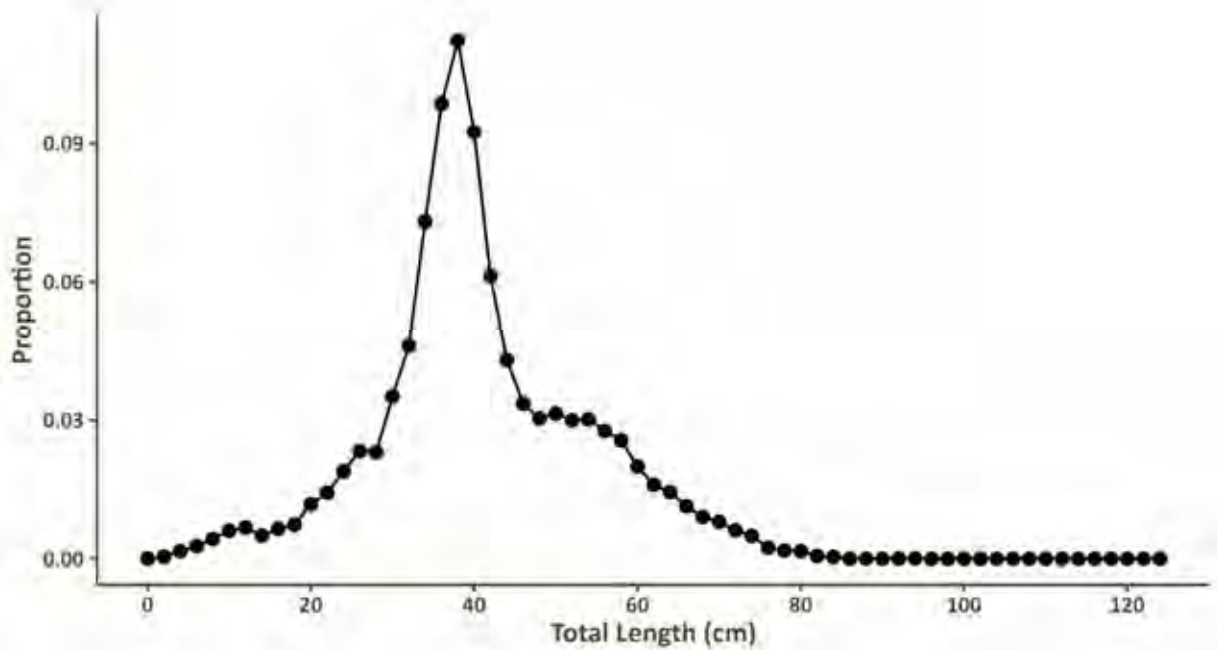


Figure 101. Length composition of red drum encountered by the South Carolina Electrofishing Survey (SC\_Electro) when pooled across all years.

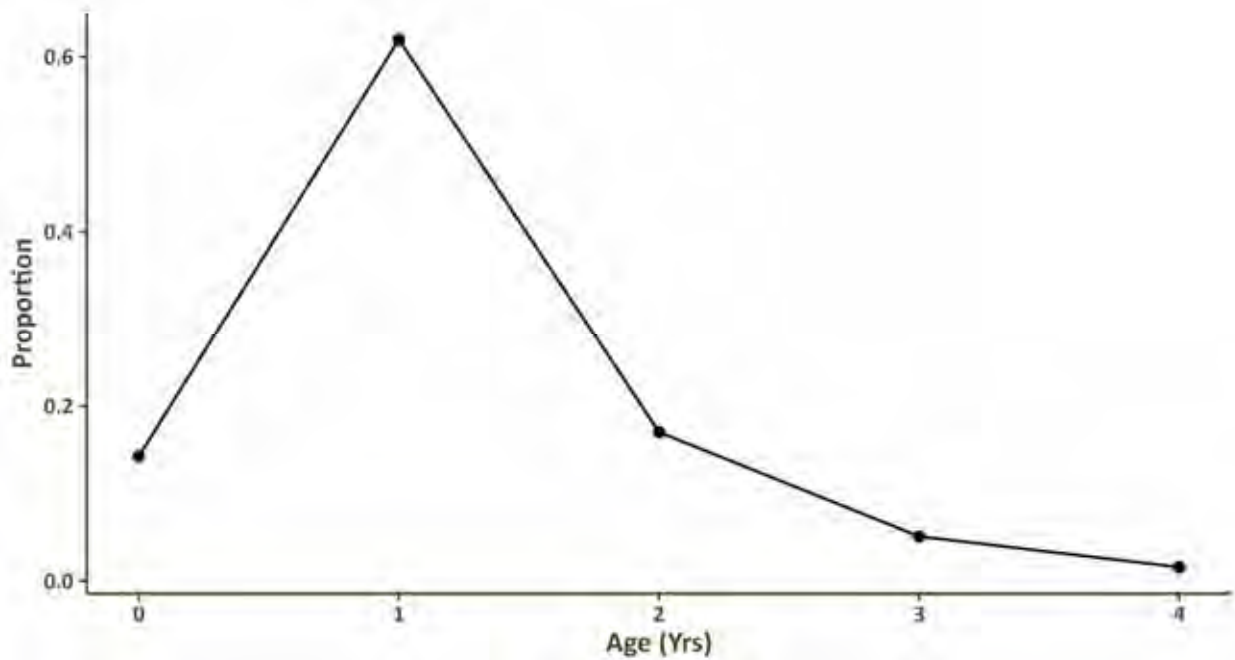
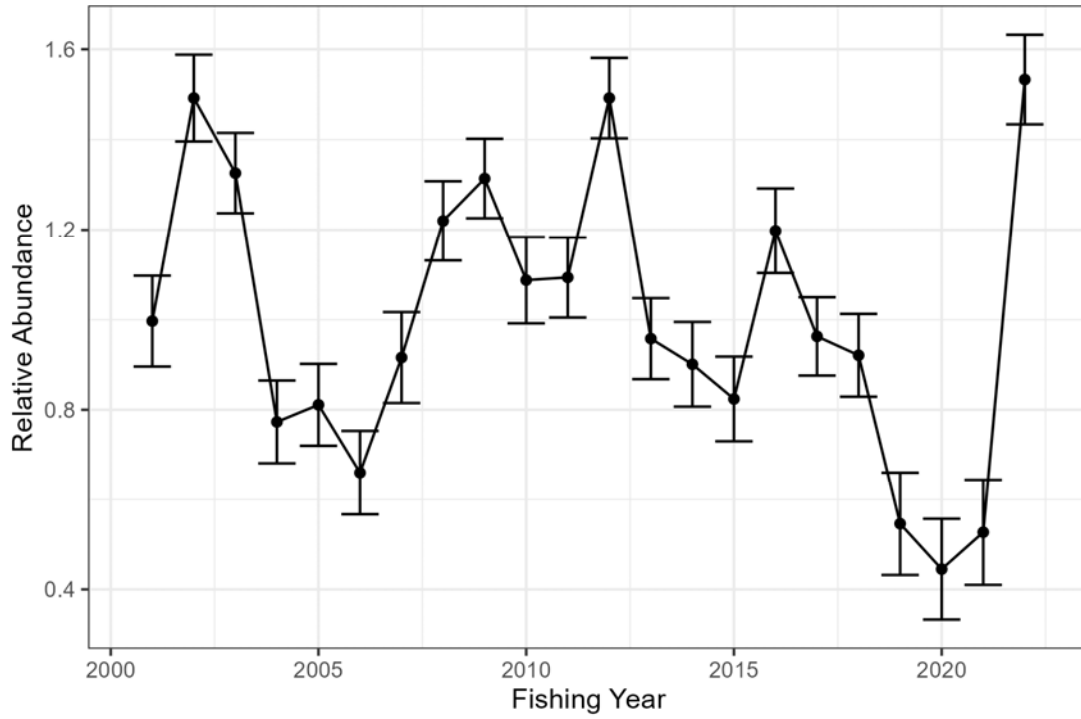
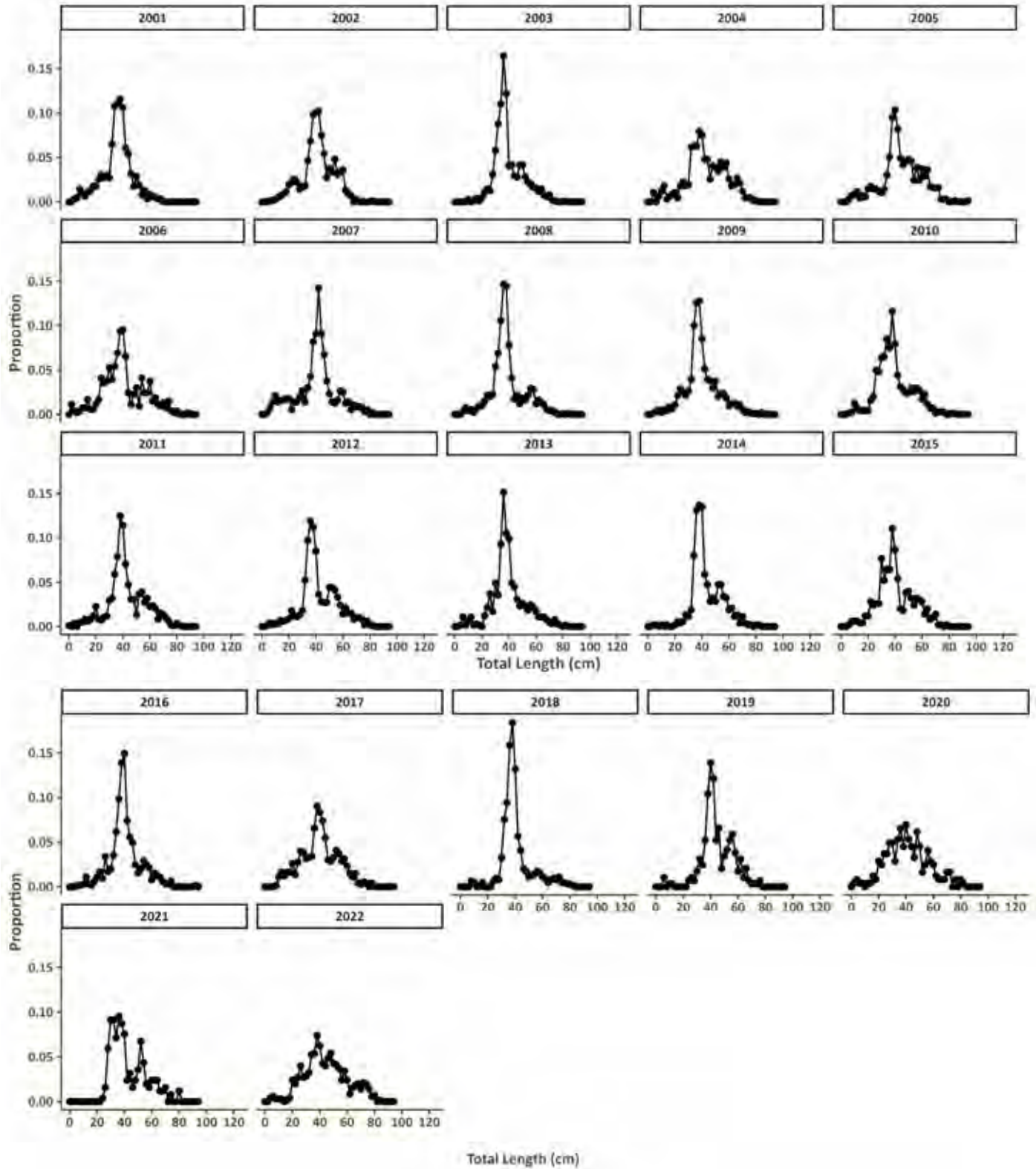


Figure 102. Age composition of red drum encountered by the South Carolina Electrofishing Survey (SC\_Electro) when pooled across all years. Age 4 represents an age 4+ group.

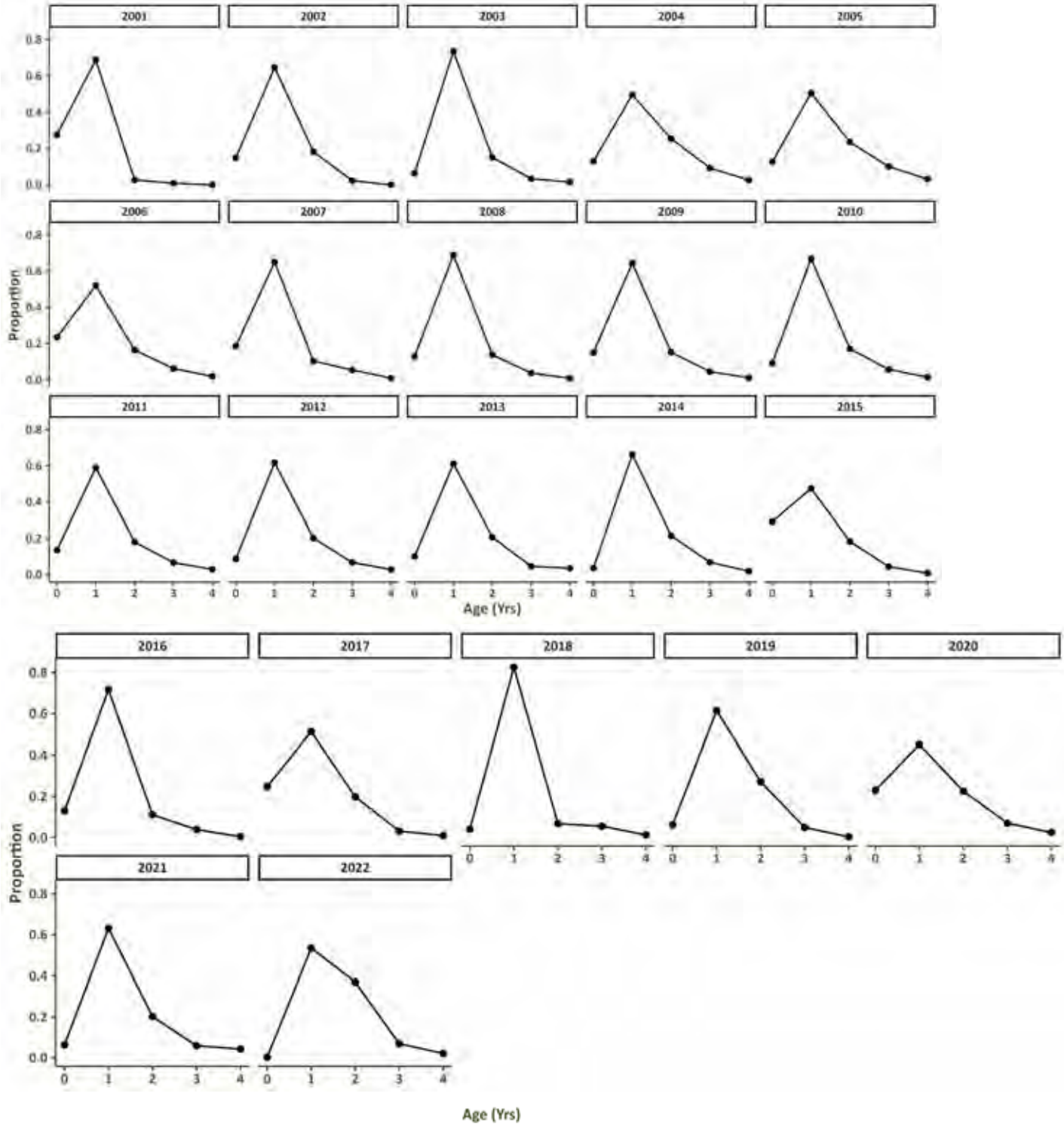


**Figure 103. South Carolina Electrofishing Survey (SC\_Electro) relative abundance, standardized to its mean, from 2001-2022. Error bars are  $\pm$  one standard error.**





**Figure 104. Annual length compositions developed for the South Carolina Electrofishing Survey (SC\_Electro).**



**Figure 105.** Annual age compositions developed for the South Carolina Electrofishing Survey (SC\_Electro). Note, age represents biological age assuming a September 1 birthday and age-4 represents a 'plus' group.

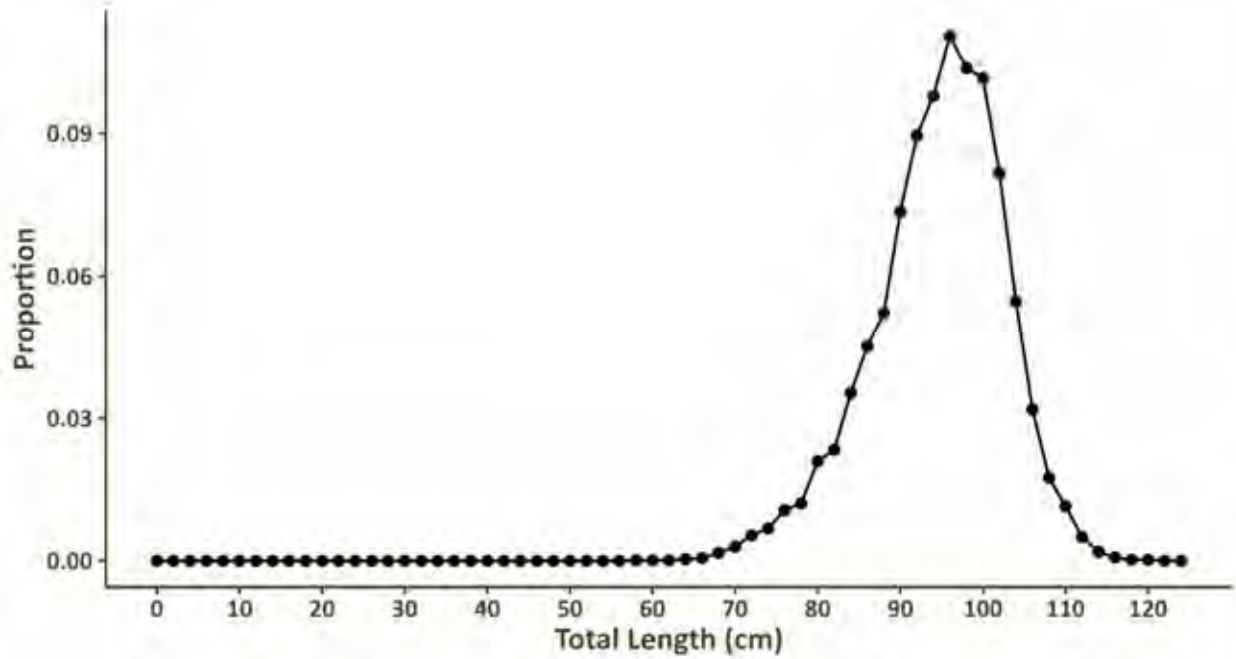


Figure 106. Length composition of red drum encountered by the South Carolina Contemporary Longline Survey (SC\_Longline\_contemporary) when pooled across all years.

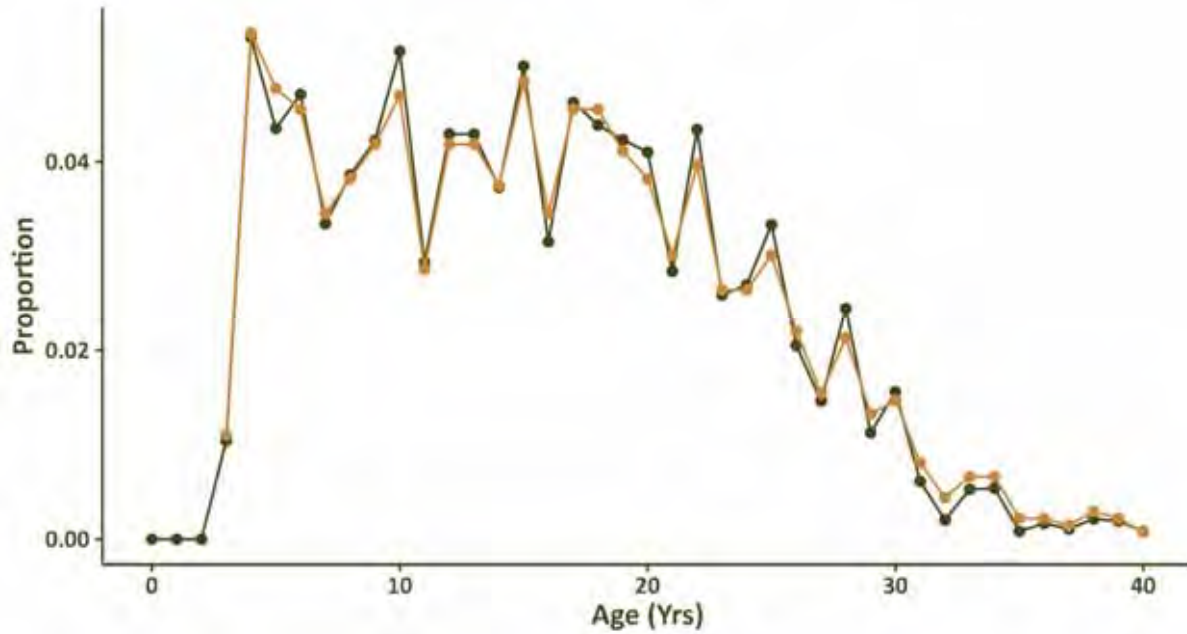


Figure 107. Age composition of red drum encountered by the South Carolina Contemporary Longline Survey (SC\_Longline\_contemporary) when pooled across all years using either raw, randomly selected aged fish (orange) and the best fit proportional odds logistic regression model (green).

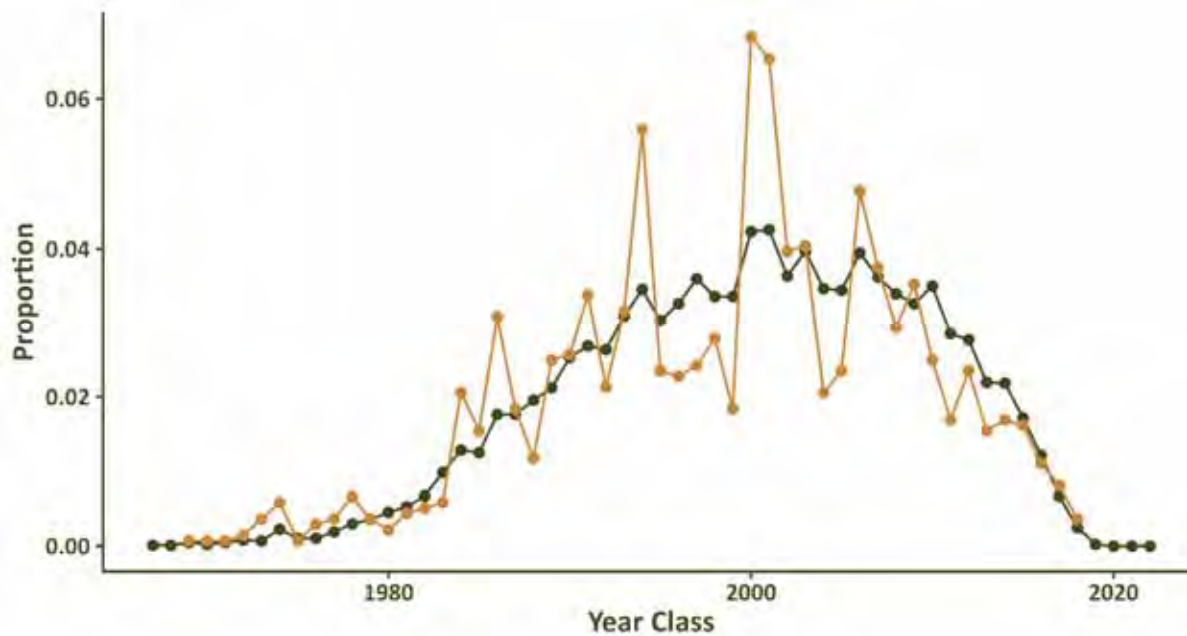
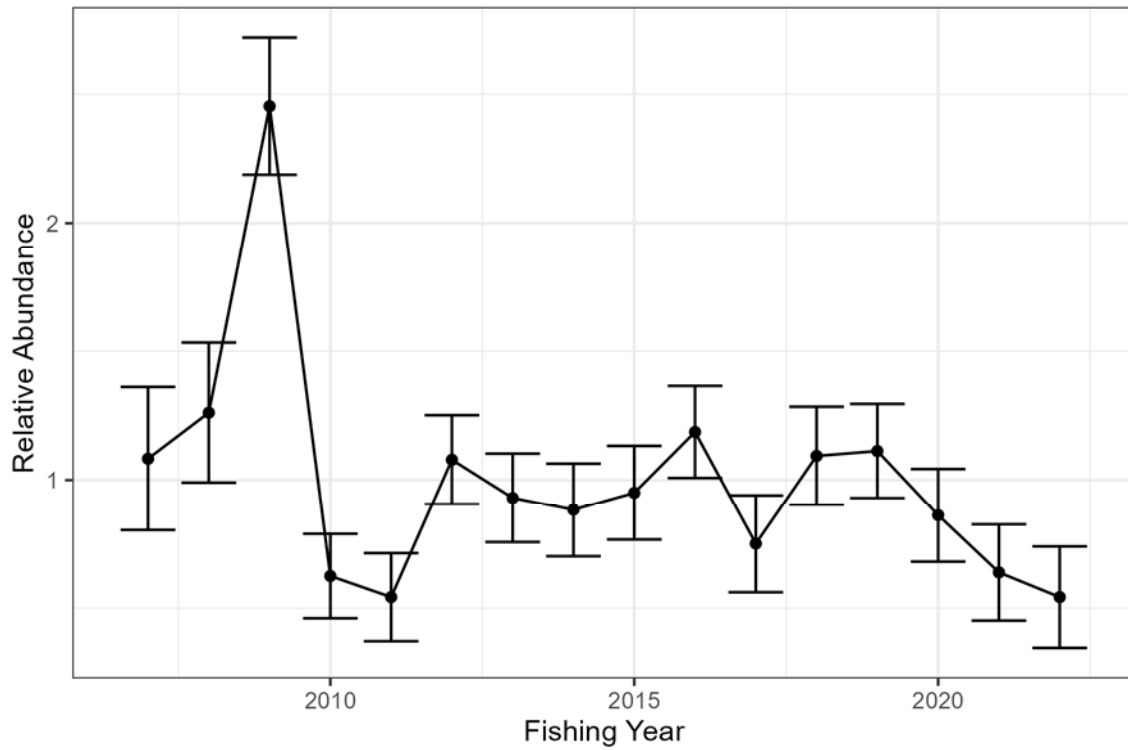


Figure 108. Year class composition of red drum encountered by the South Carolina Contemporary Longline Survey (SC\_Longline\_contemporary) when pooled across all years using either raw, randomly selected aged fish (orange) and the best fit proportional odds logistic regression model (green).



**Figure 109. SCDNR South Carolina Contemporary Longline Survey (SC\_Longline\_contemporary) relative abundance, standardized to its mean, from 2007-2022. Error bars are  $\pm$  one standard error.**

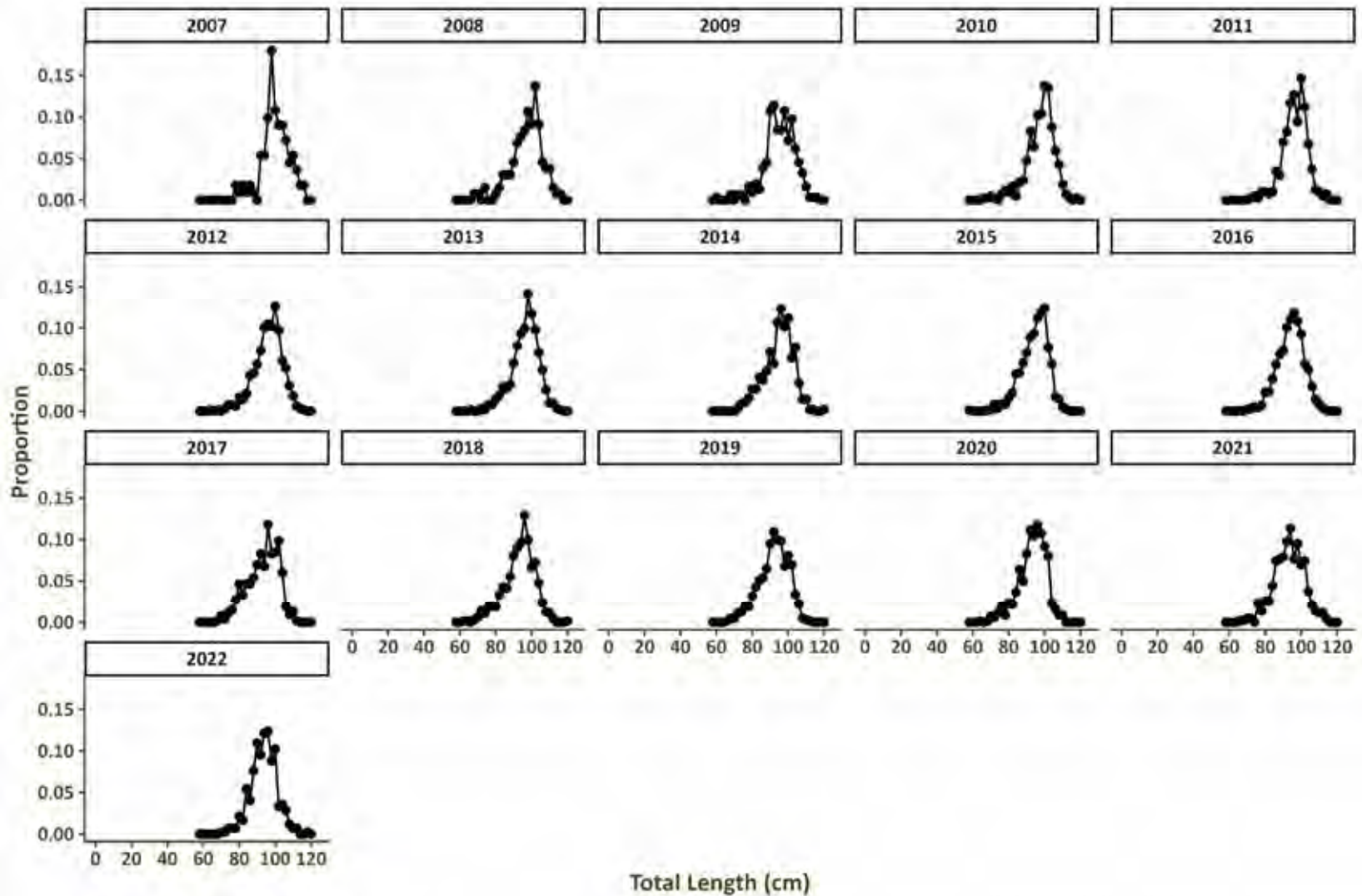


Figure 110. Annual length compositions developed for the South Carolina Contemporary Longline Survey (SC\_Longline\_contemporary).



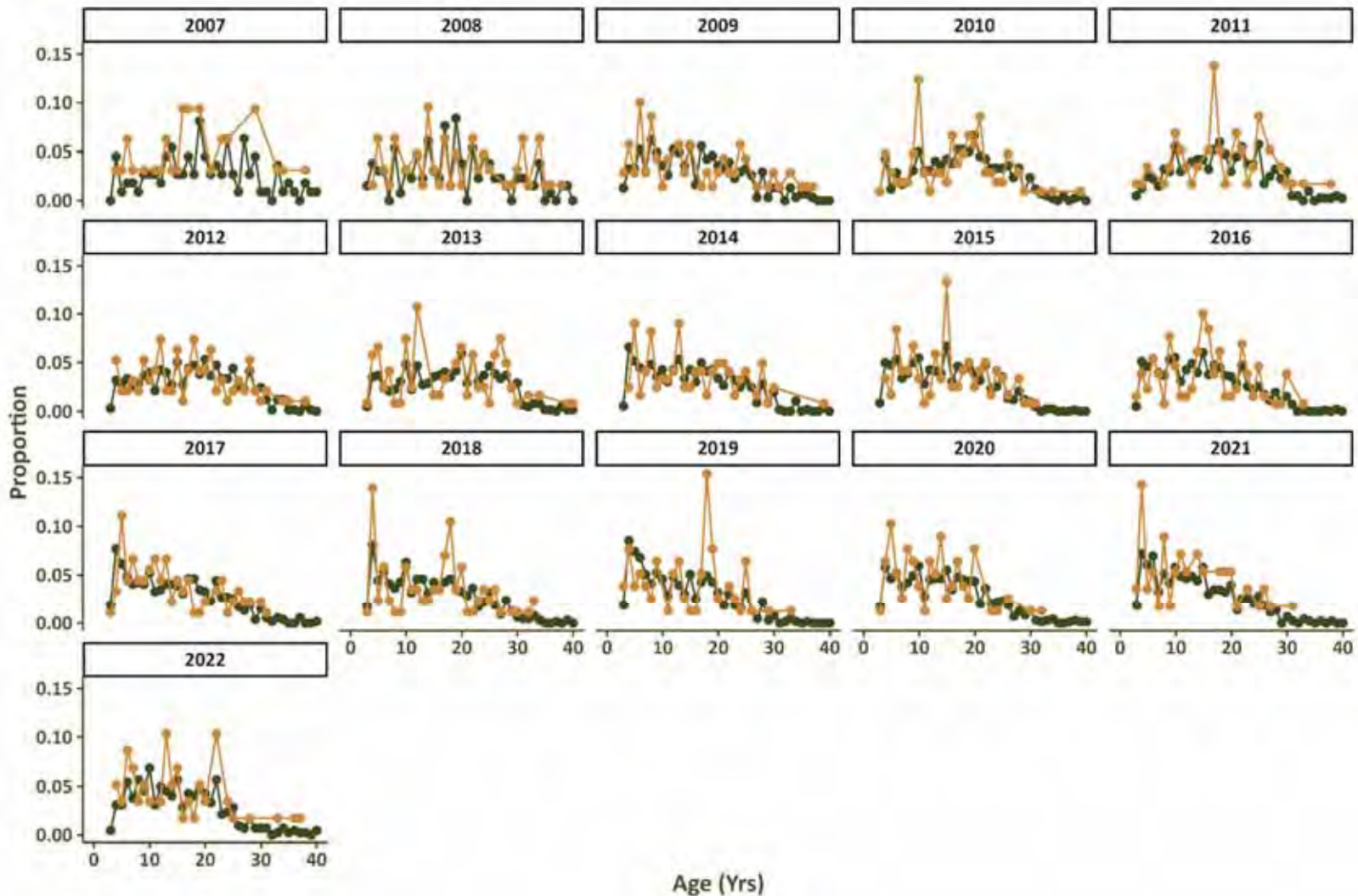


Figure 111. Annual age compositions developed for the South Carolina Contemporary Longline Survey (SC\_Longline\_contemporary) using either raw, randomly selected aged fish (orange) and the best fit proportional odds logistic regression model (green).

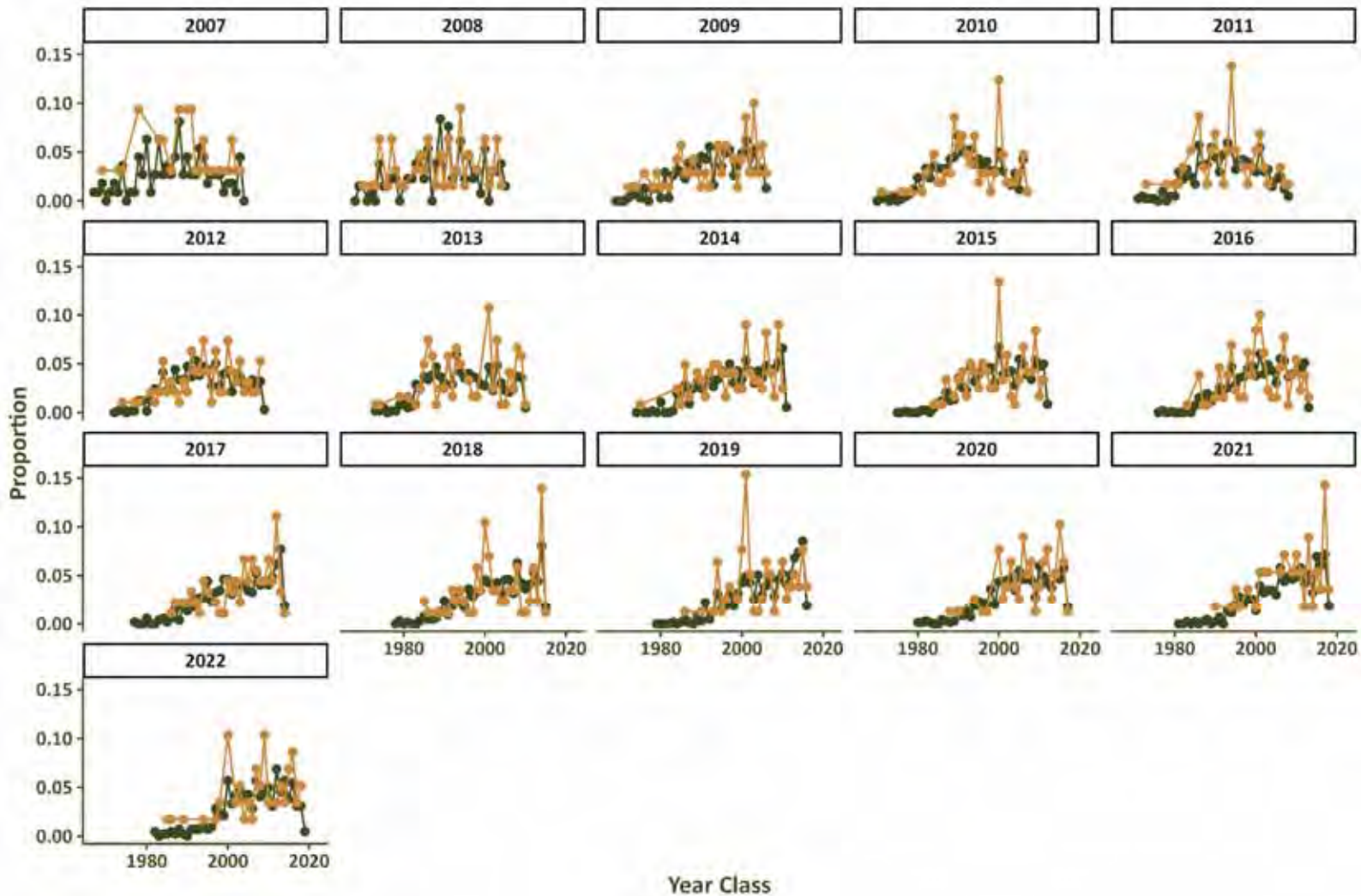


Figure 112. Annual year class compositions developed for the South Carolina Contemporary Longline Survey (SC\_Longline\_contemporary) using either raw, randomly selected aged fish (orange) and the best fit proportional odds logistic regression model (green).





**Figure 113. Coastal Georgia counties with approximate Wassaw Sound and Altamaha River system sample areas.**

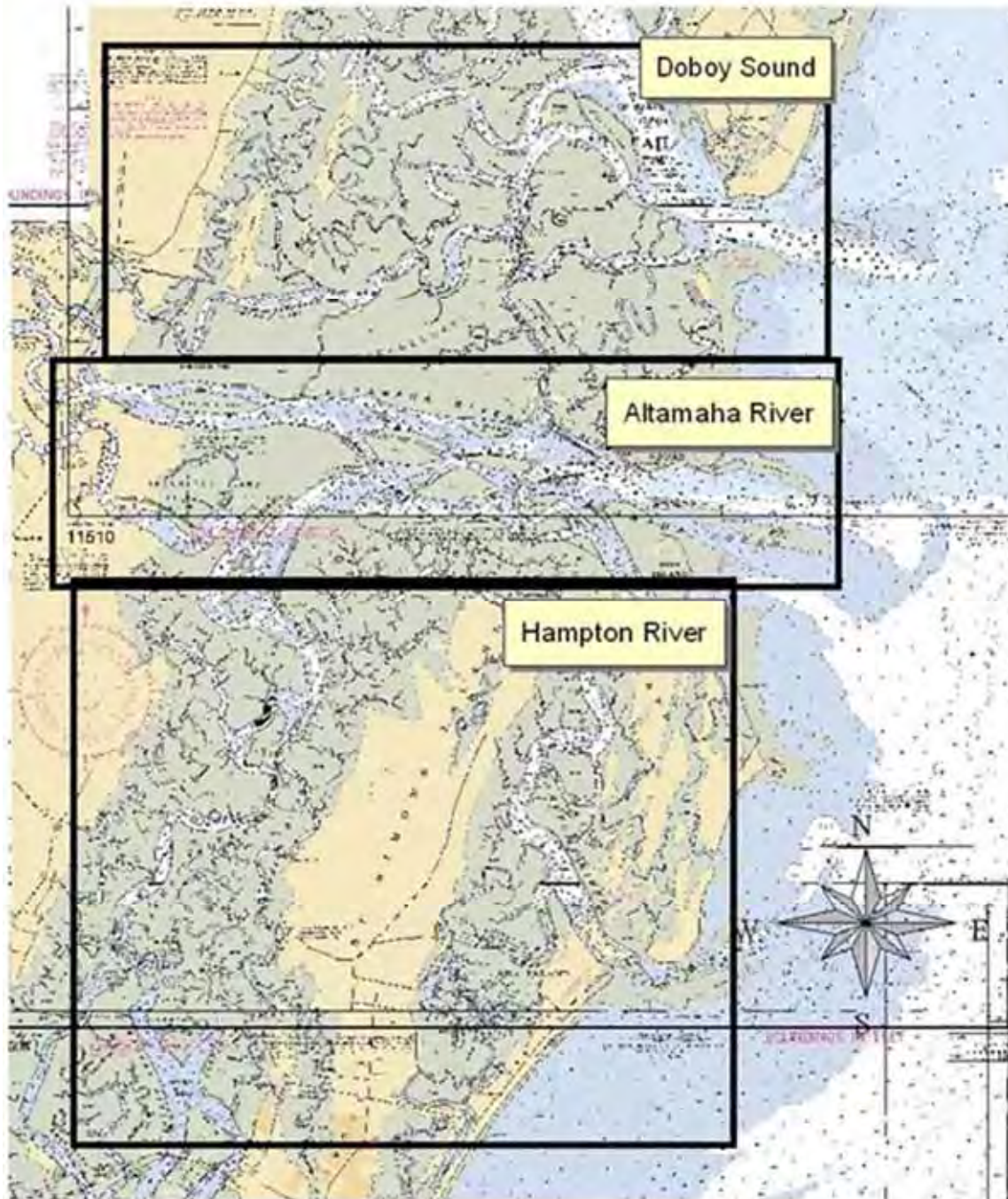


Figure 114. Sample areas for Altamaha River System.



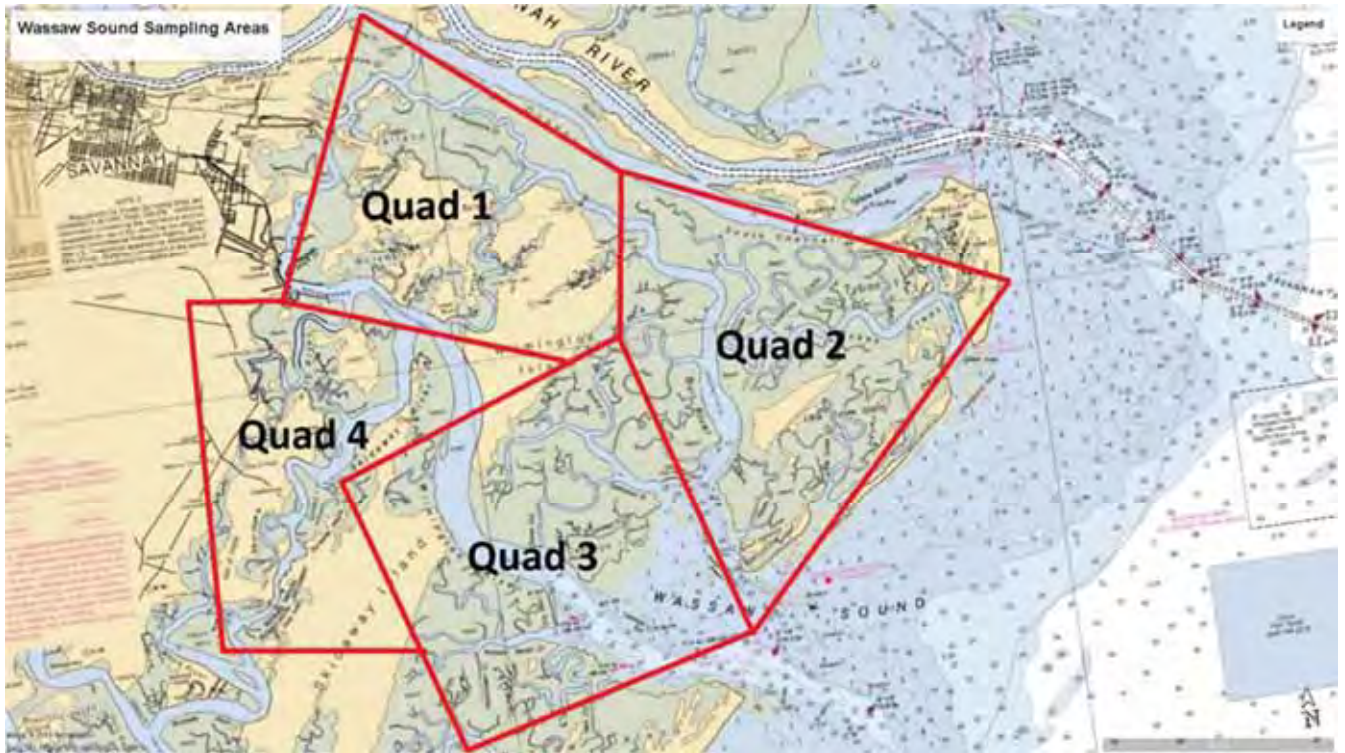


Figure 115. Sample areas for Wassaw Sound.

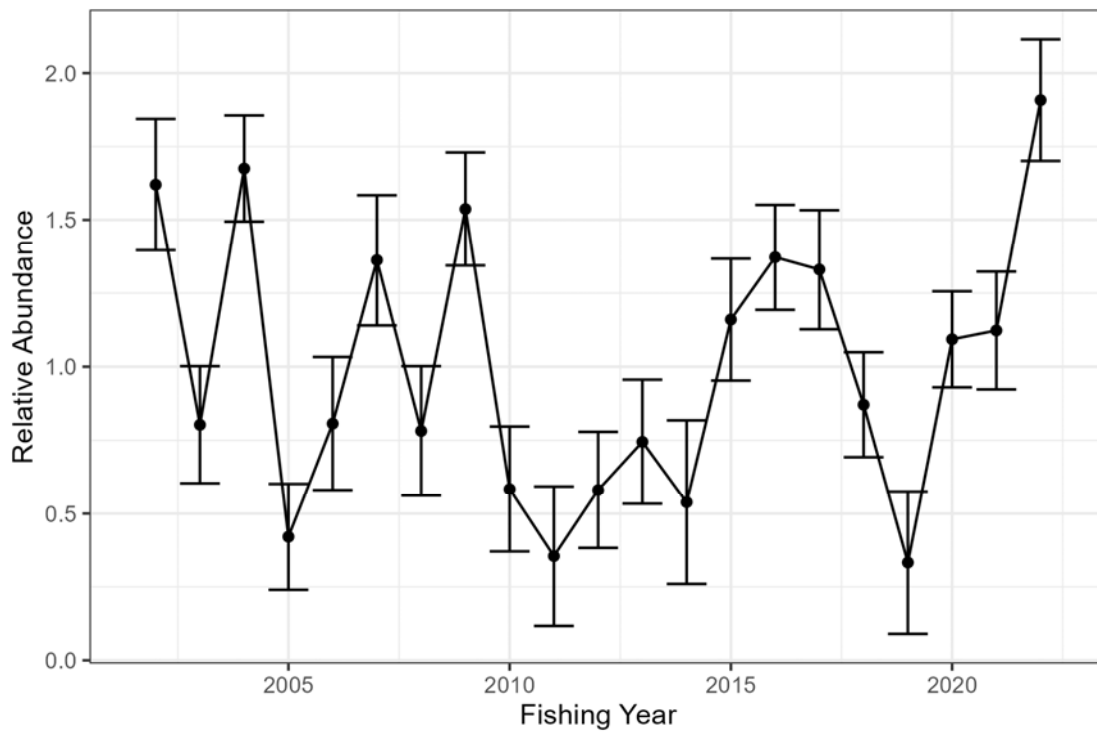
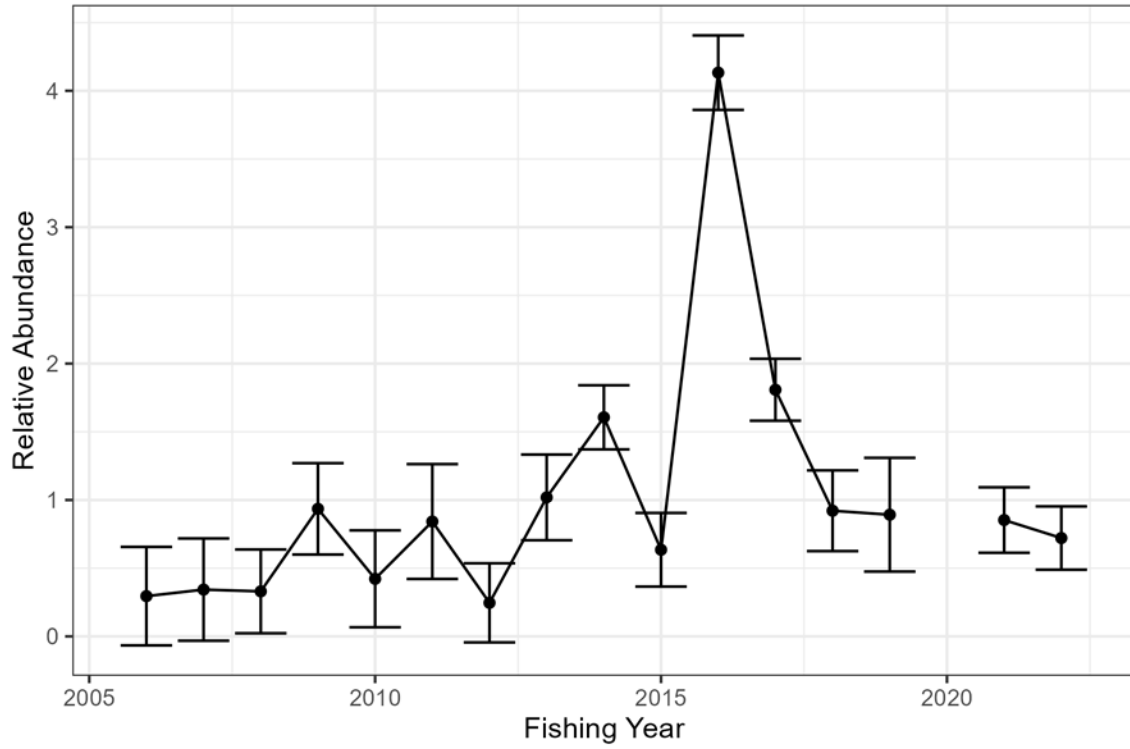
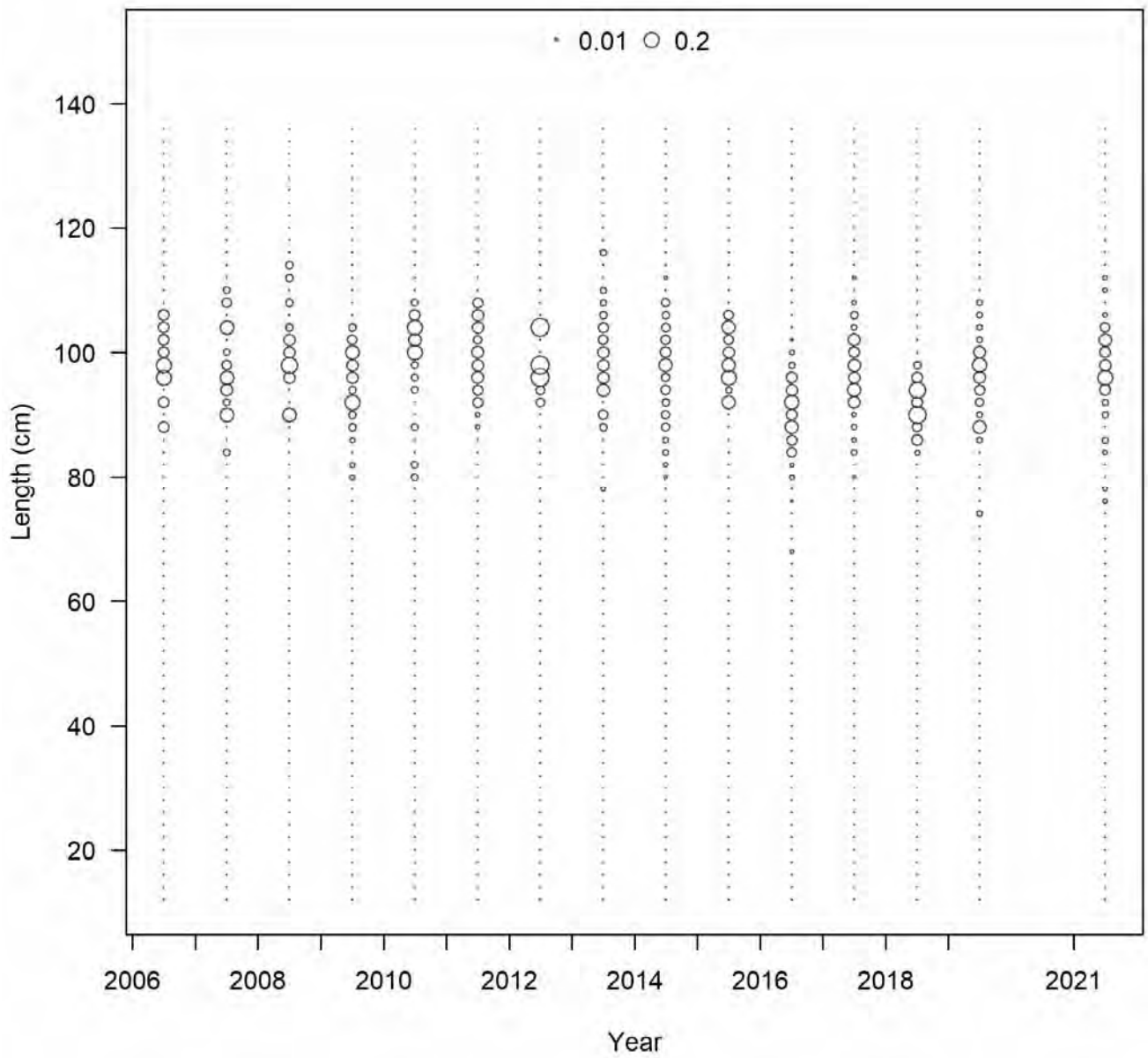


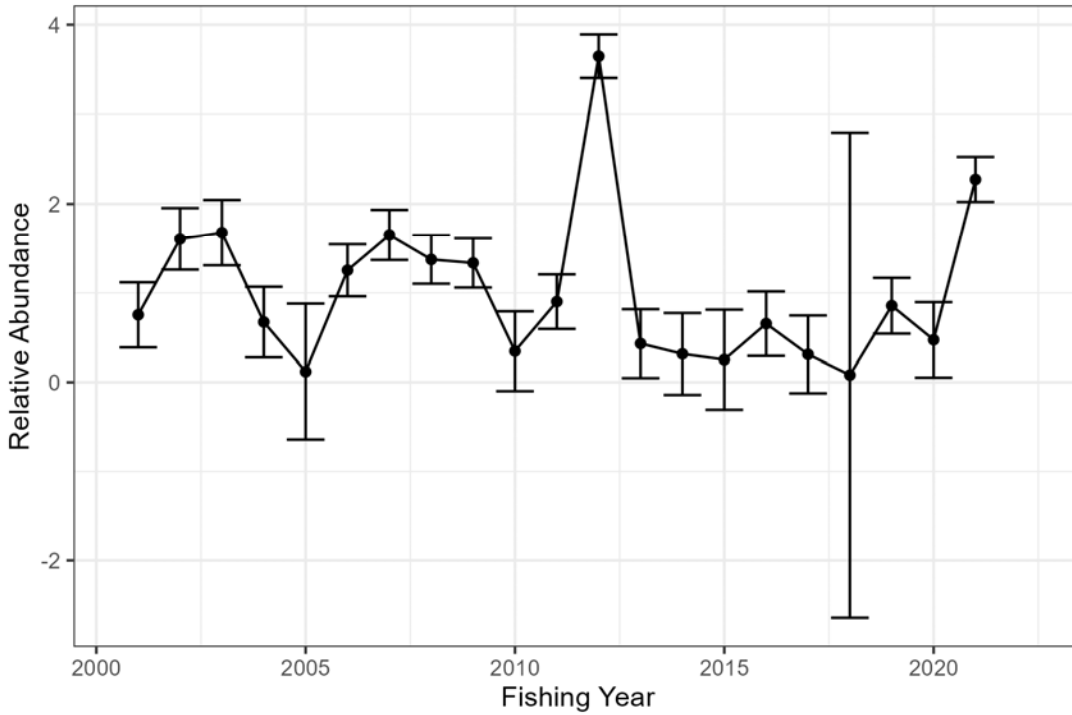
Figure 116. Georgia Gill Net Survey (GA\_GillNet) relative abundance, standardized to its mean, from 2002-2022. Error bars are  $\pm$  one standard error.



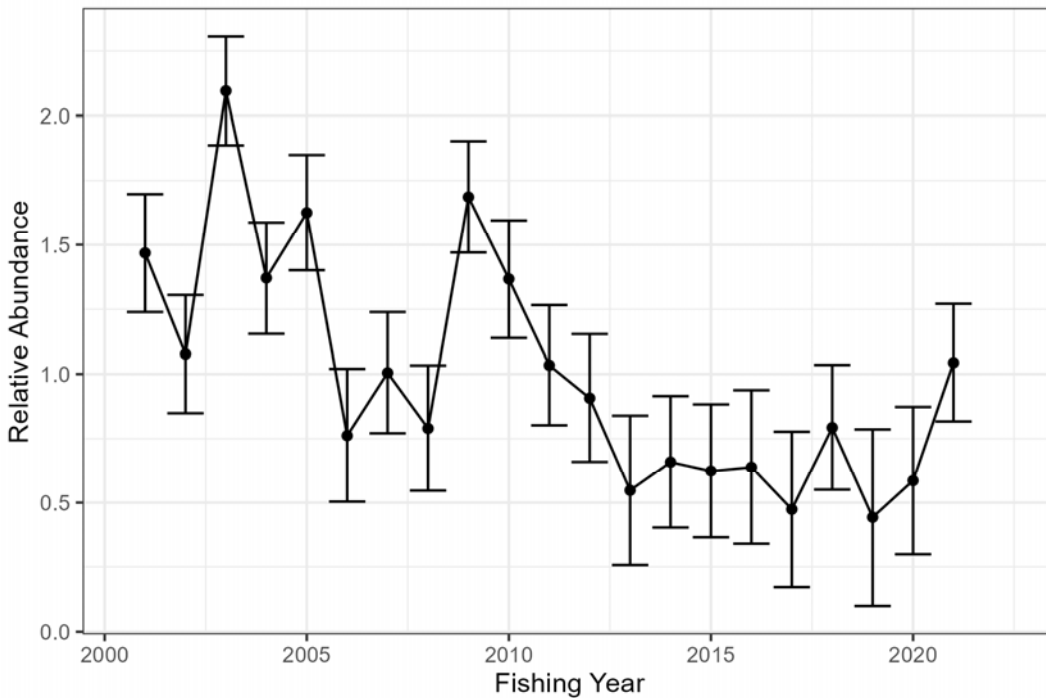
**Figure 117. Georgia Longline Survey (GA\_Longline) relative abundance, standardized to its mean, from 2006-2022. Error bars are  $\pm$  one standard error.**



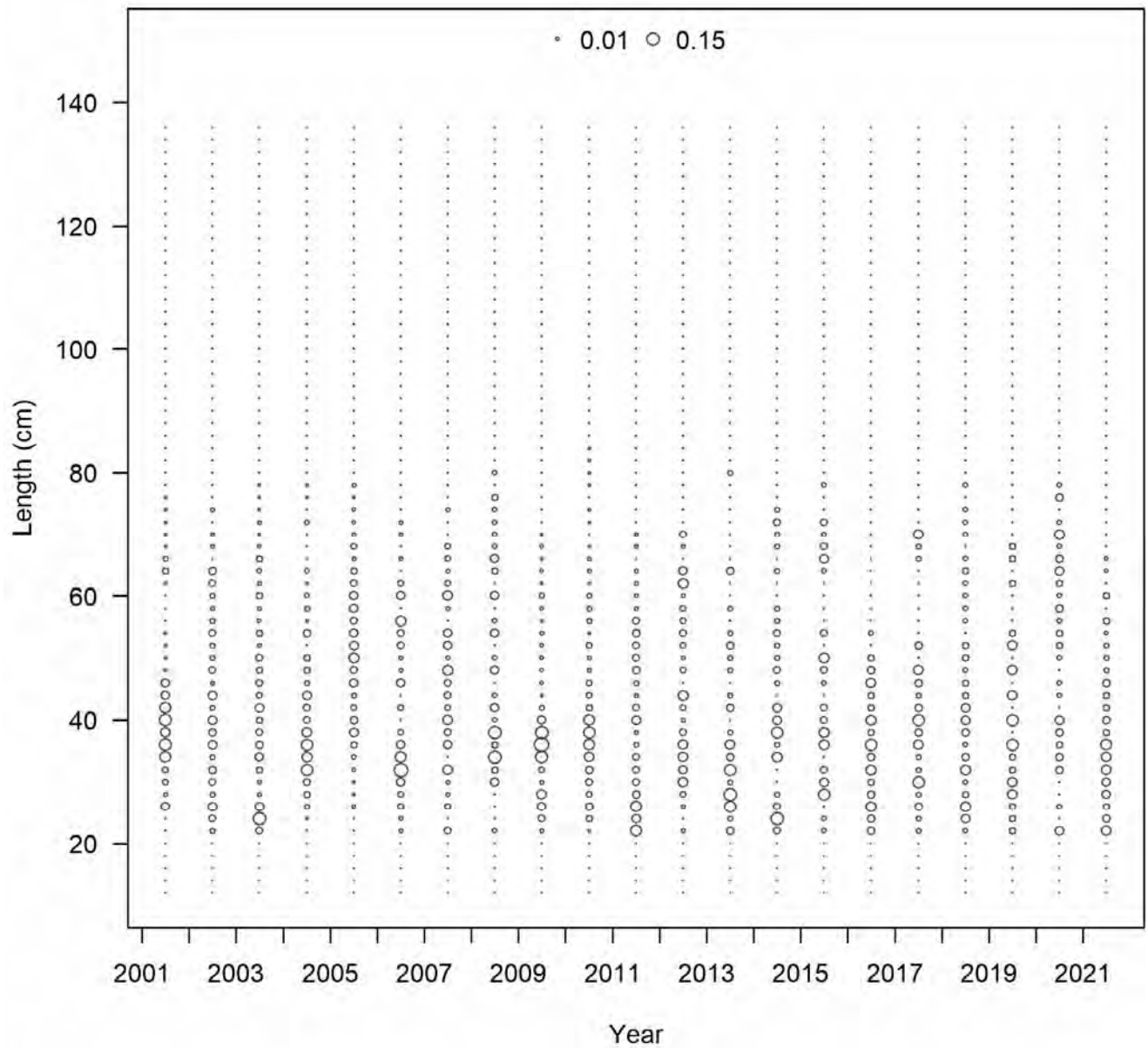
**Figure 118. Length compositions of red drum captured during the Georgia longline survey (GA\_Longline).**



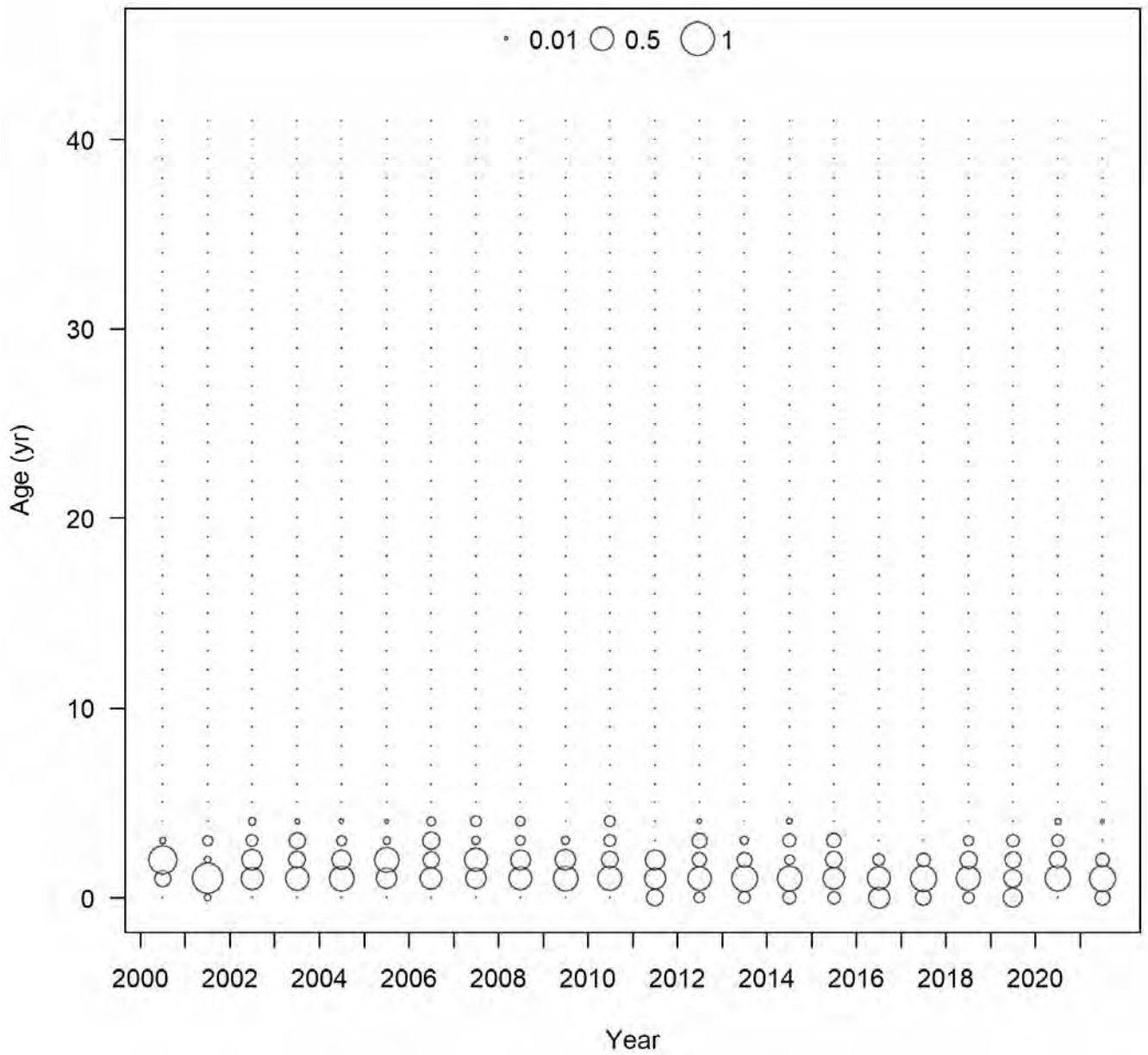
**Figure 119.** Florida 21.3 Meter Haul Seine Survey (FL\_21.3\_HaulSeine) relative abundance, standardized to its mean, from 2001-2021. Error bars are  $\pm$  one standard error.



**Figure 120.** Florida 183 Meter Haul Seine Survey (FL\_183\_HaulSeine) relative abundance, standardized to its mean, from 2001-2021. Error bars are  $\pm$  one standard error.

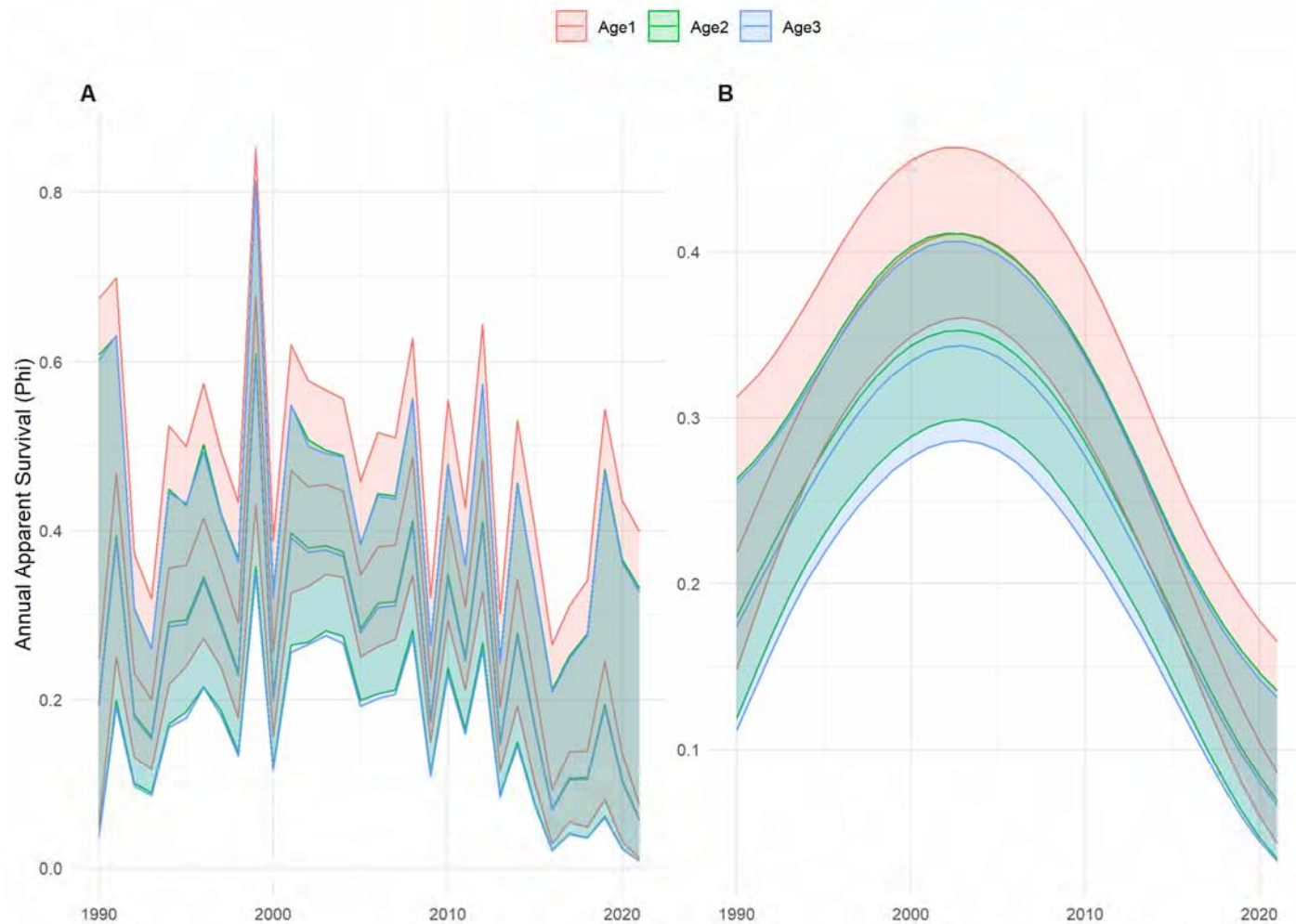


**Figure 121. Length compositions of red drum captured during the Florida 183 Meter Haul Seine Survey (FL\_183\_HaulSeine).**

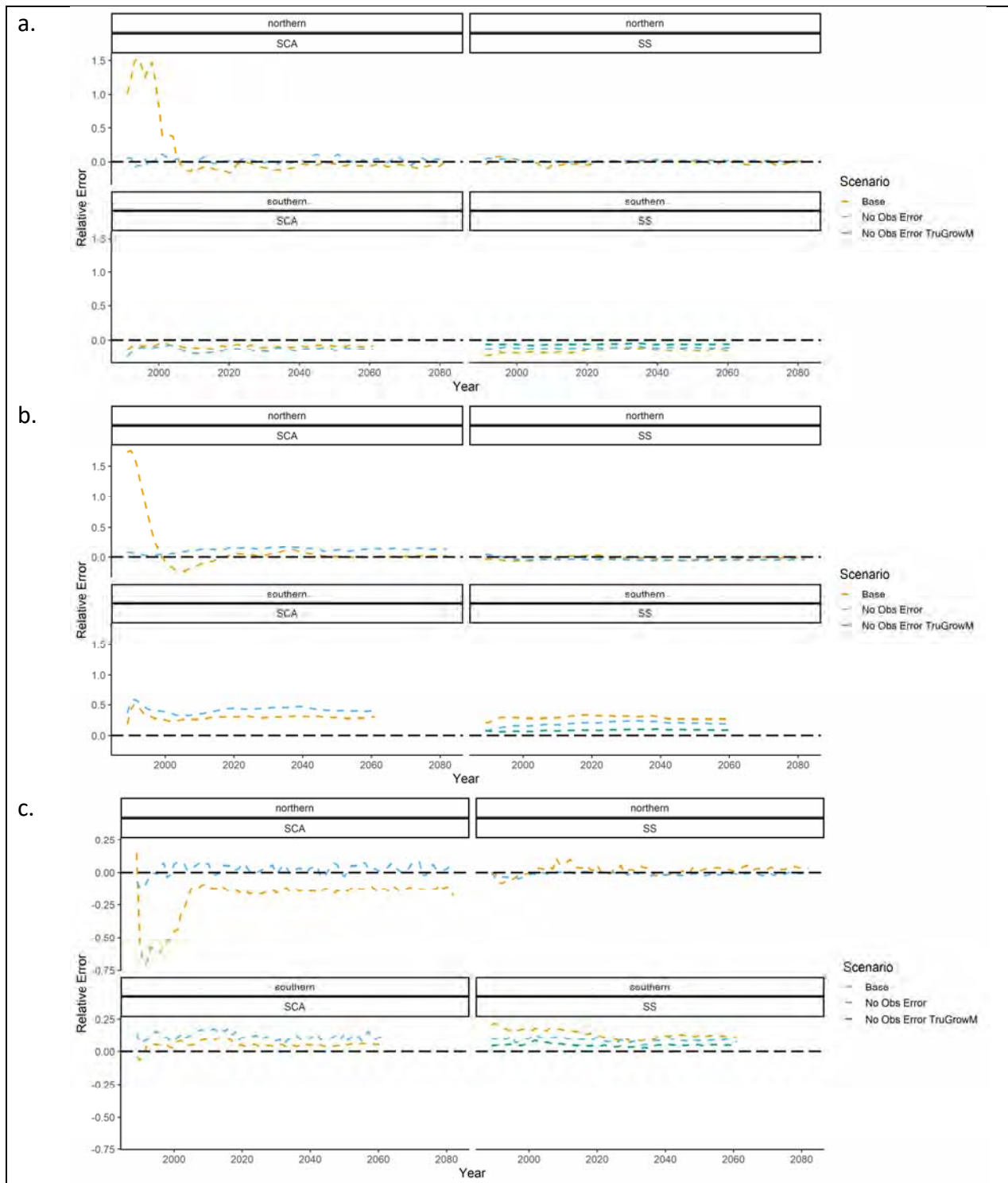


**Figure 122. Age distribution of red drum captured during the Florida 183 Meter Haul Seine Survey (FL\_183\_HaulSeine).**

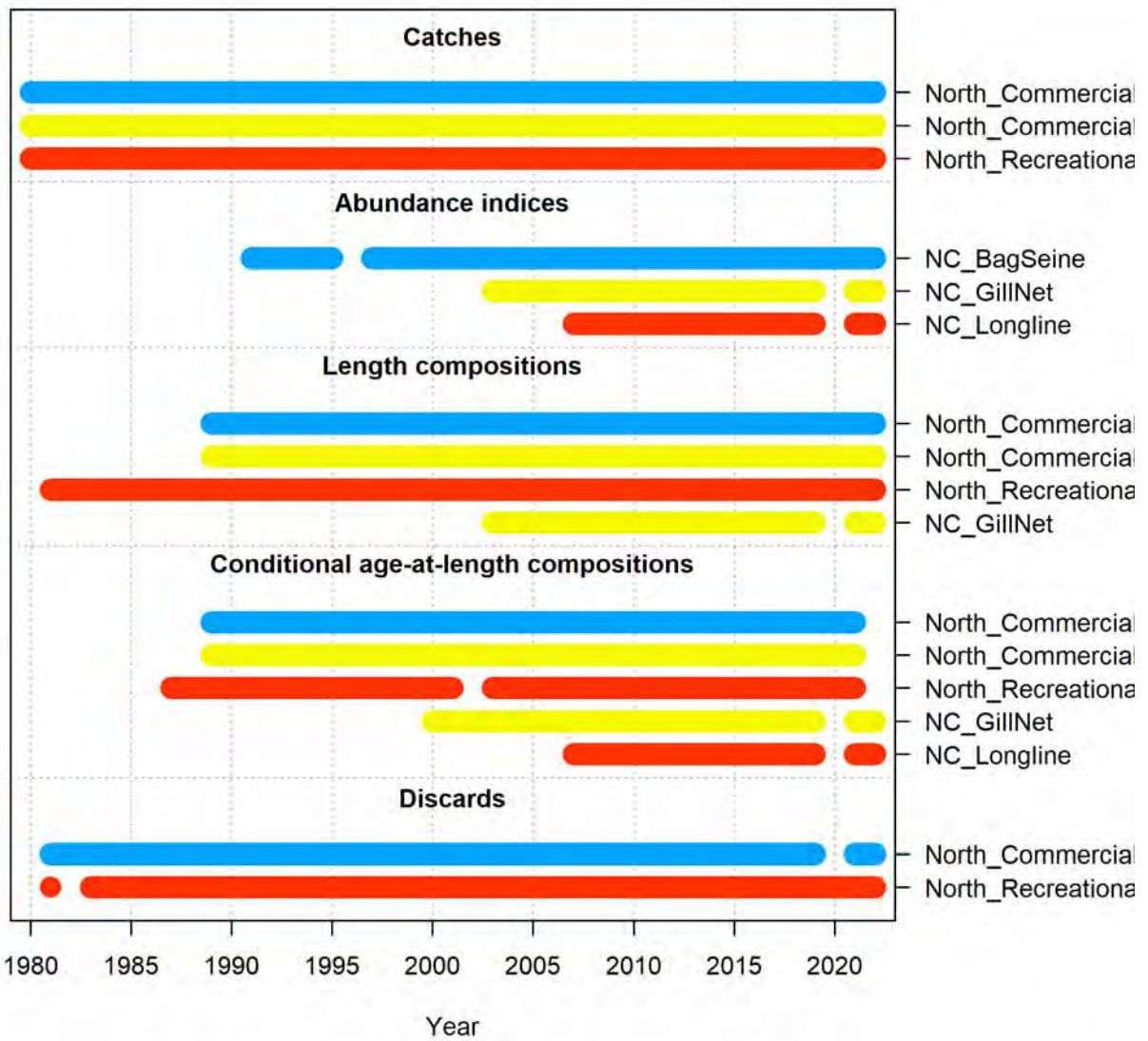




**Figure 123.** Annual apparent survival estimates of red drum from a Cormack-Jolly-Seber mark-recapture model developed using conventional tagging data from the South Carolina Department of Natural Resources’ fisheries-independent monitoring programs. Data include releases from 1990-2021, with recaptures from 1990-2022. A) Annual apparent survival estimates are a function of red drum age + time. B) Annual apparent survival estimates are a function of red drum age + s(time).



**Figure 124.** Relative error for southern SS EM three-year F ratio estimates (a), mature female number estimates (b), and subadult number estimates (c) from the Base scenario (data with observation error), no observation error data with the Base scenario model (No Obs Error), and no observation error data with the Base scenario and correctly specified growth and natural mortality (No Obs Error TruGrowM). The black dashed line indicates no error.



**Figure 125.** Data time series used in SS estimated selectivity model for the northern stock.

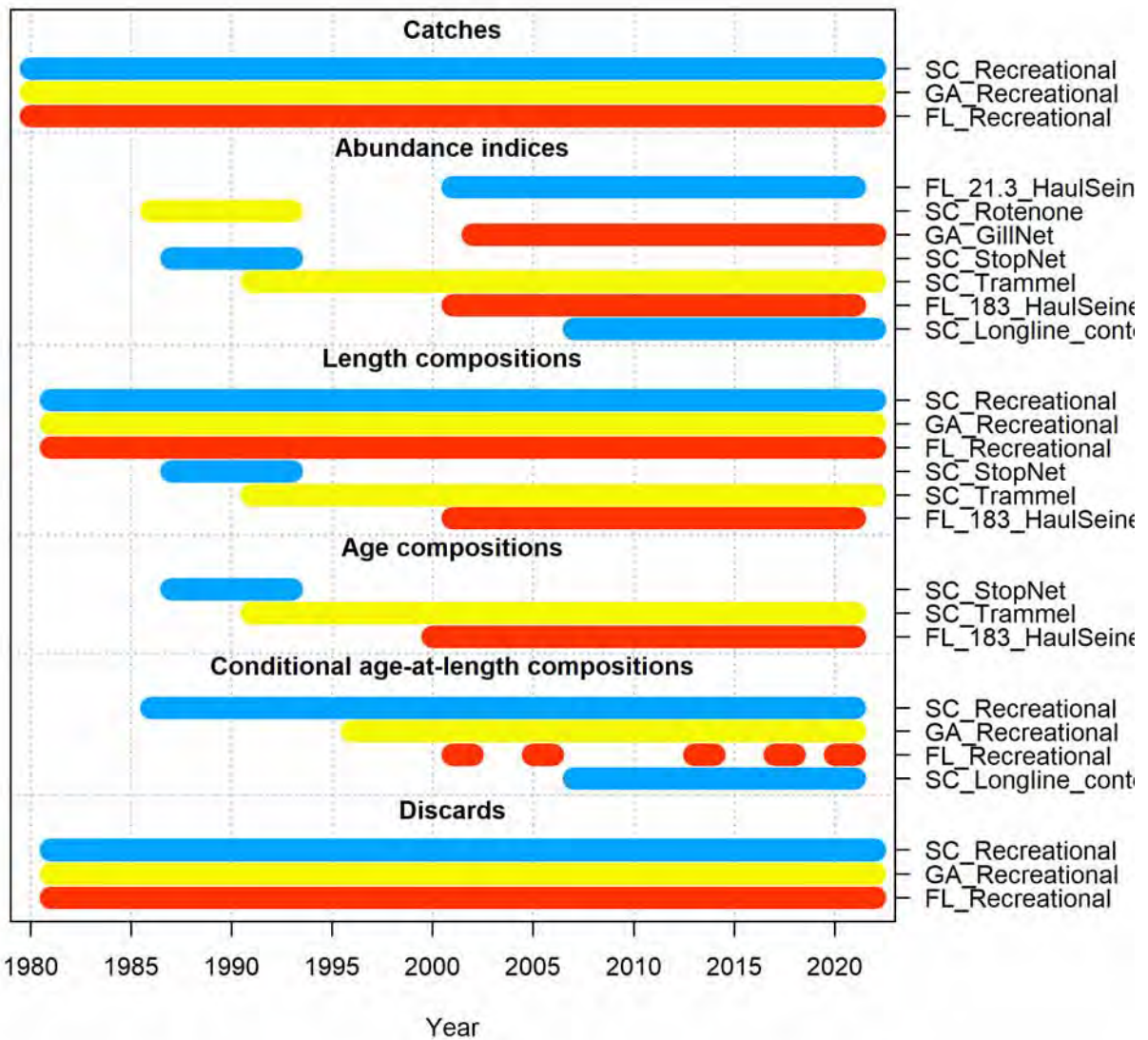


Figure 126. Data time series used in SS base model for the southern stock.



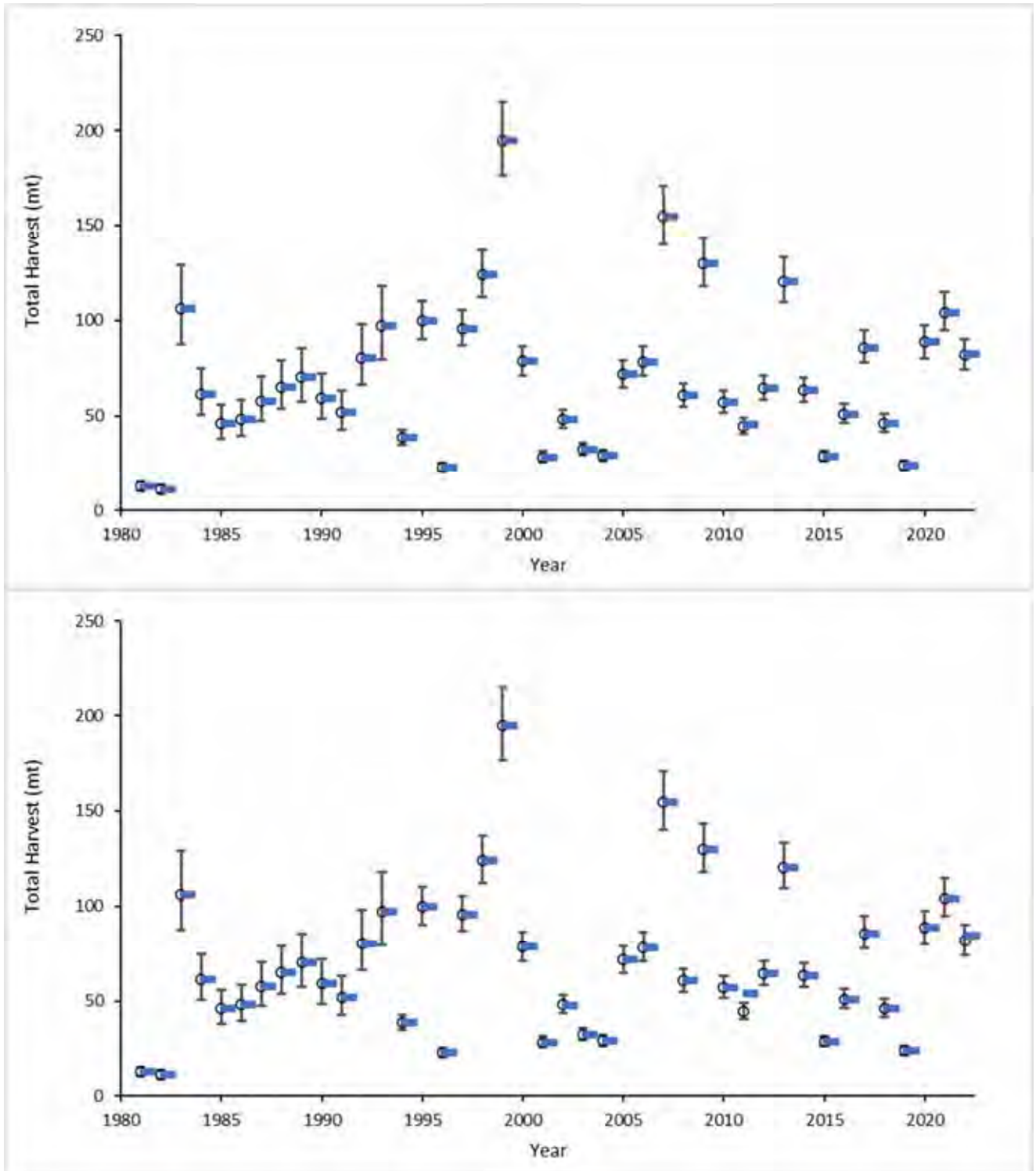
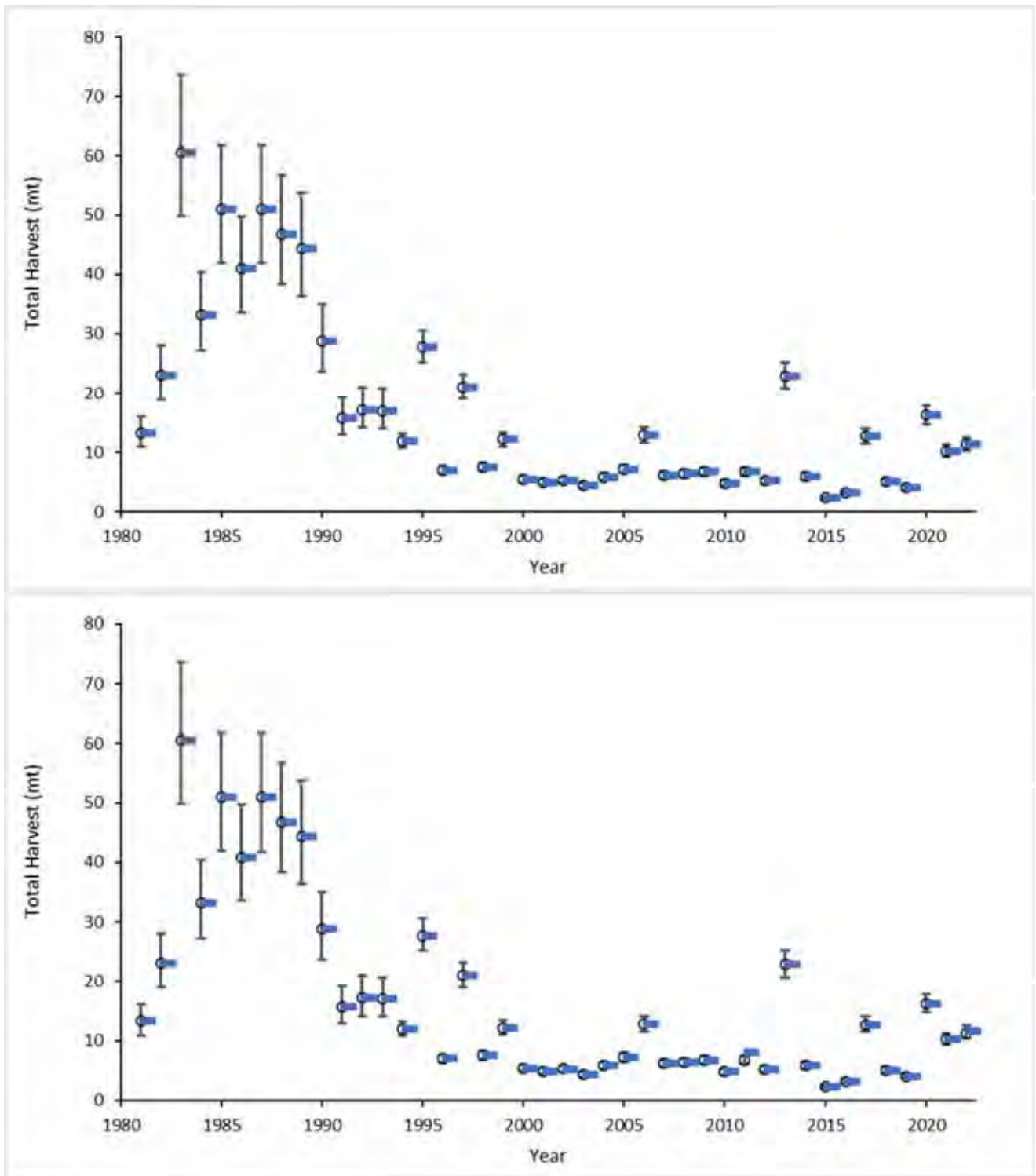
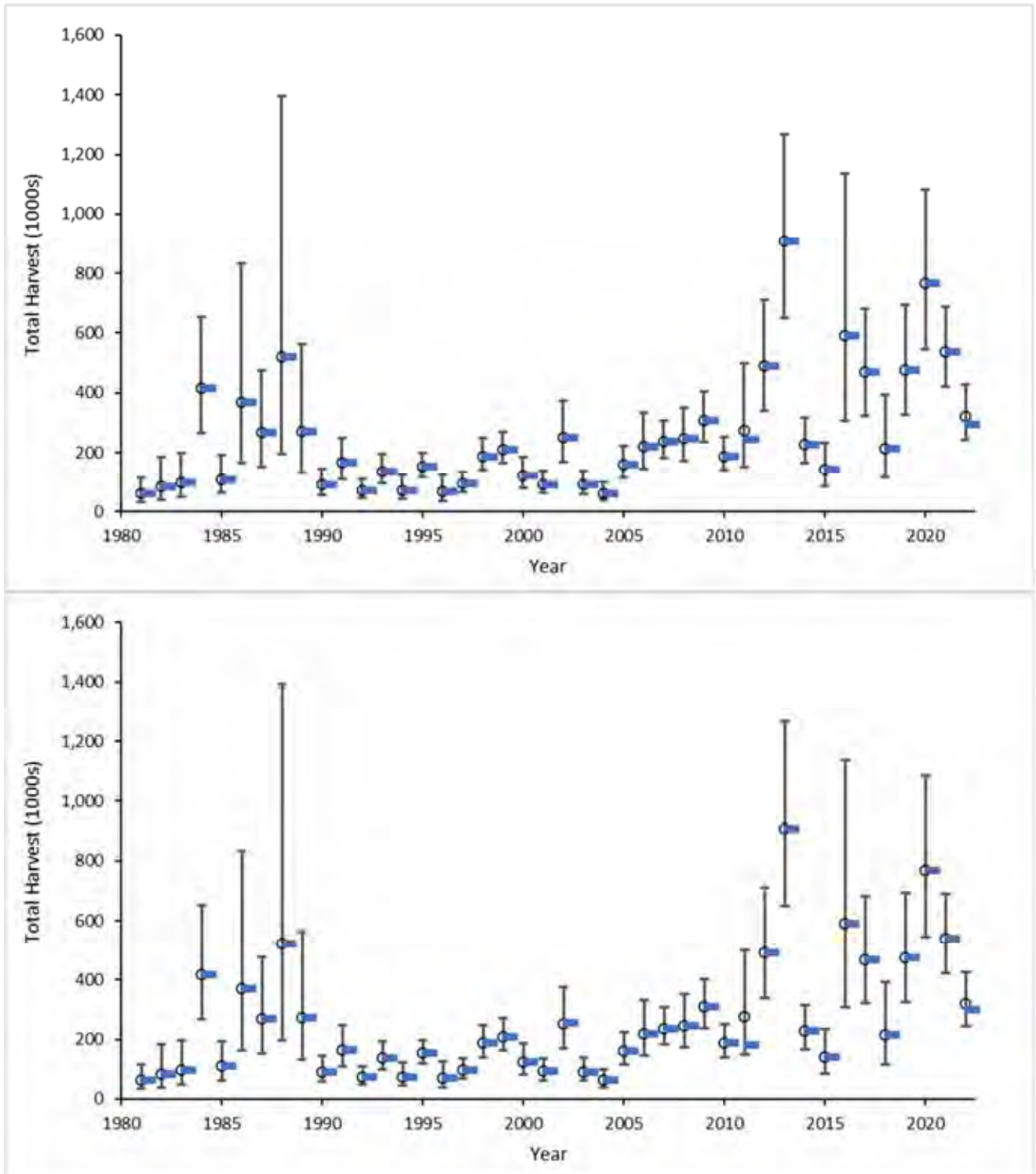


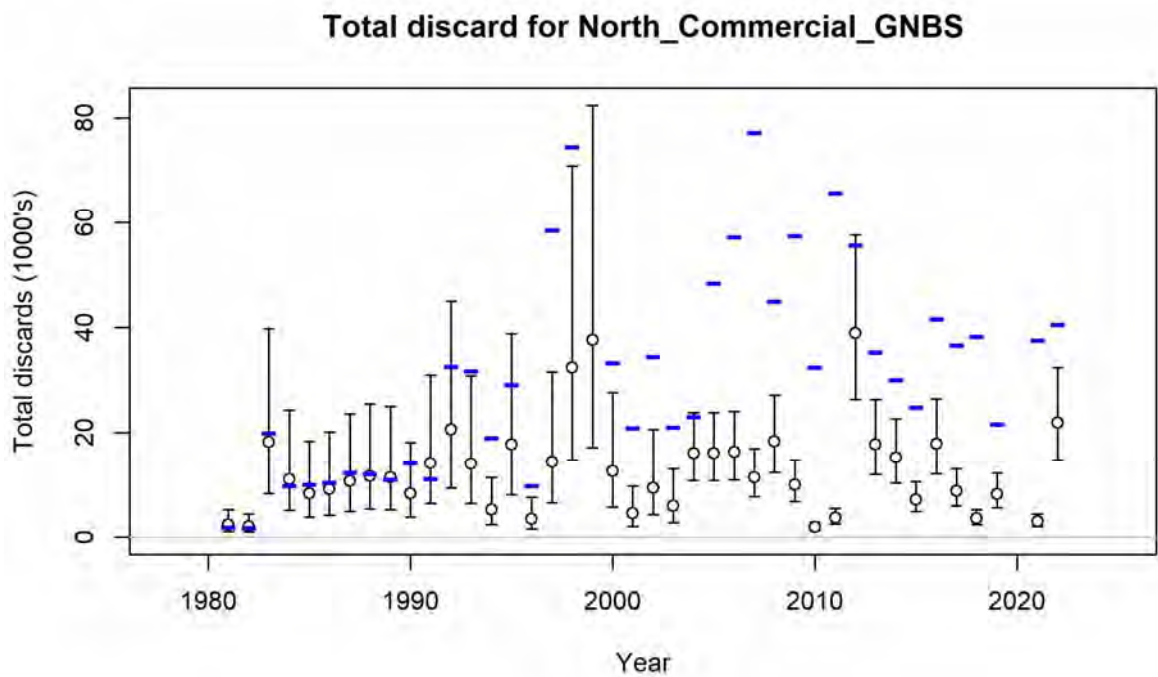
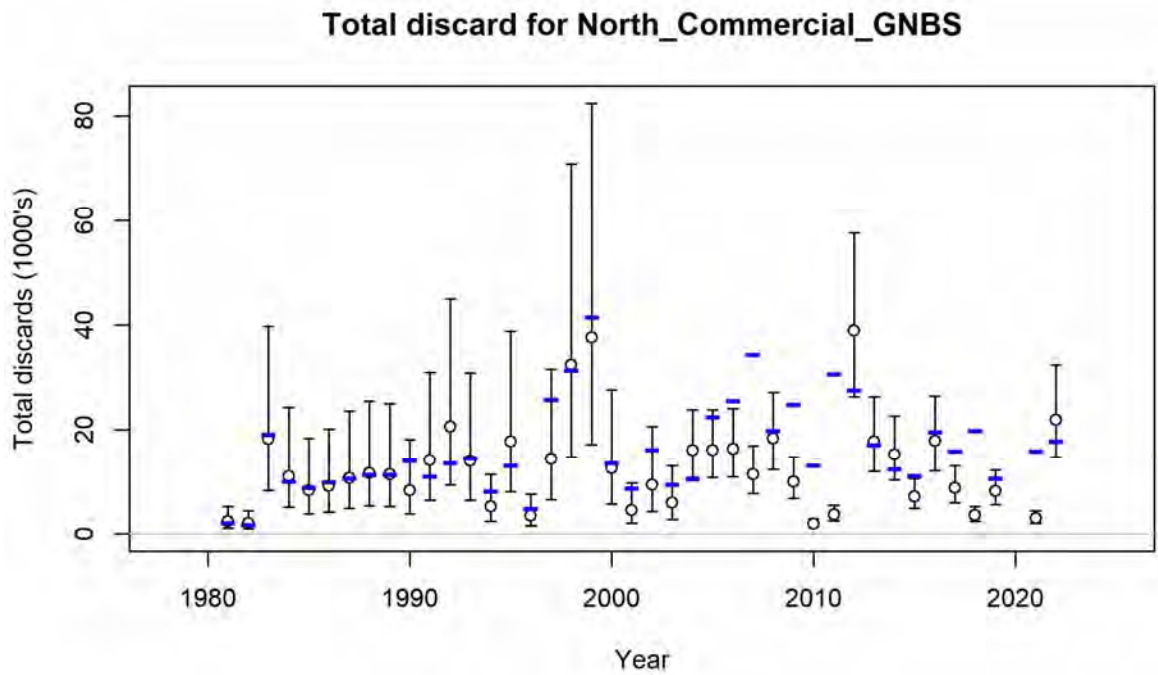
Figure 127. Observed and estimated catches for the North\_Commercial\_GNBS fleet for the northern stock SS estimated selectivity model (top) and hybrid selectivity model (bottom).



**Figure 128.** Observed and estimated catches for the North\_Commercial\_Other fleet for the northern stock SS estimated selectivity model (top) and hybrid selectivity model (bottom).

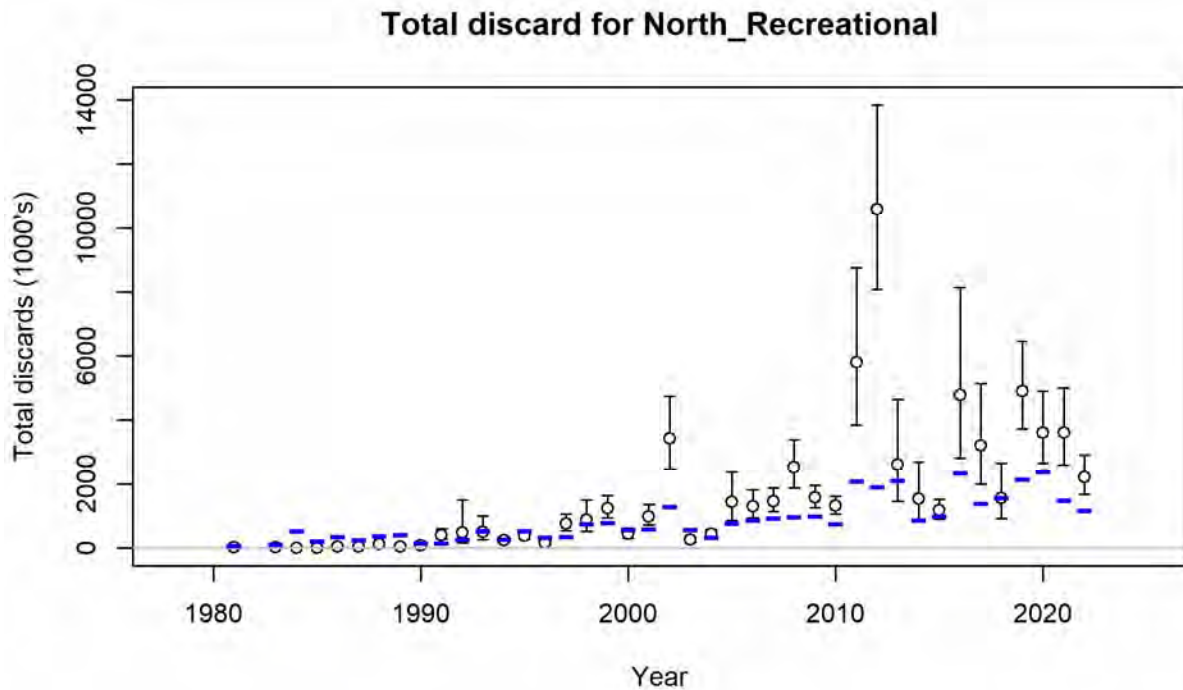
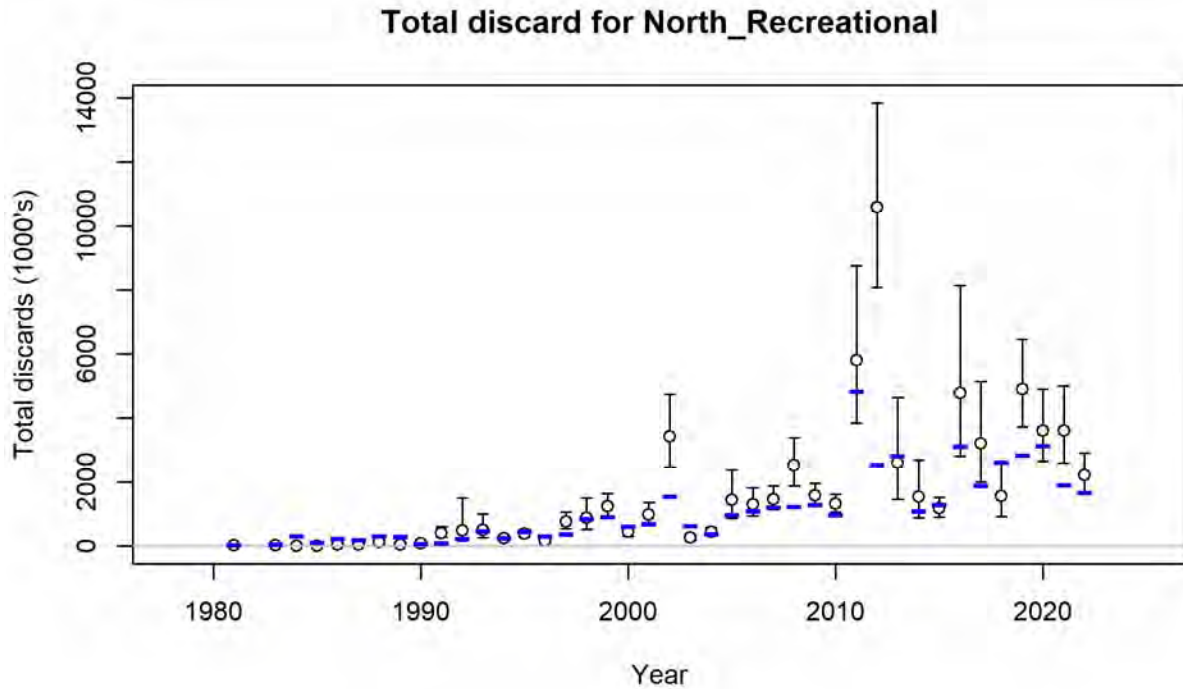


**Figure 129.** Observed and estimated catches for the North\_Recreational fleet for the northern stock SS estimated selectivity model (top) and hybrid selectivity model (bottom).

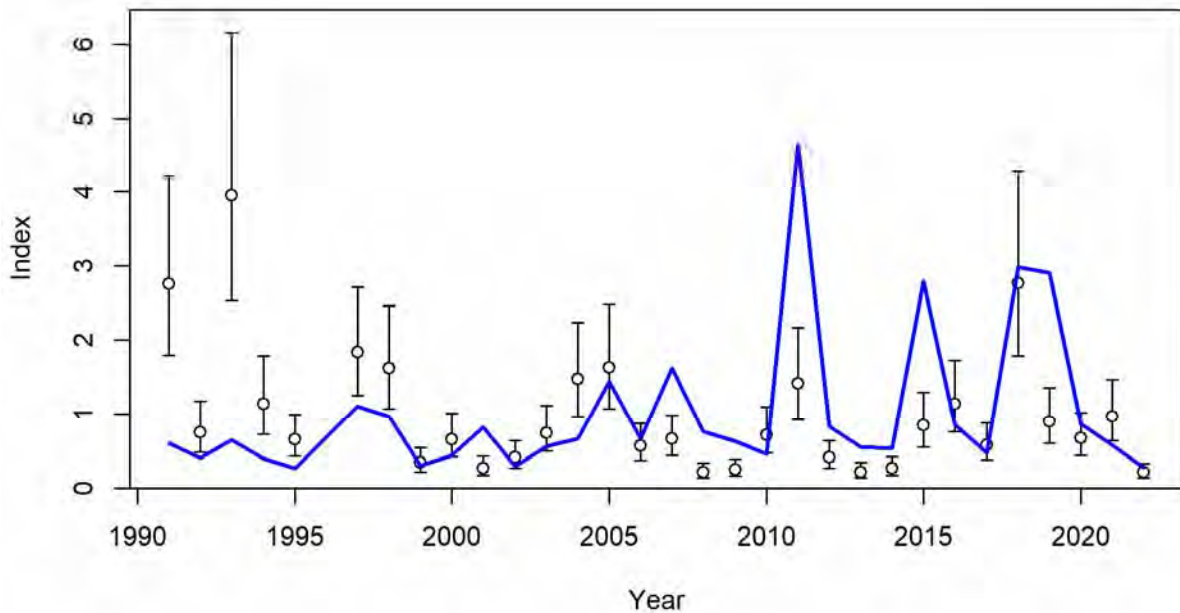
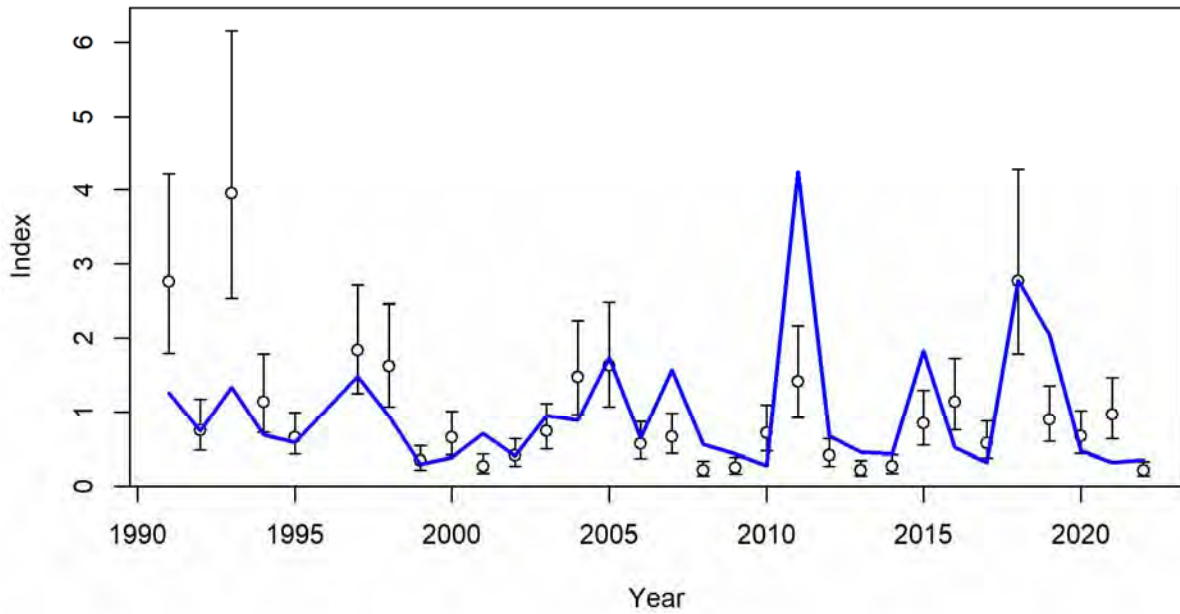


**Figure 130. Observed and estimated discards (in 1000's of fish) for the commercial gill net beach seine fleet for the northern stock SS estimated selectivity model (top) and hybrid selectivity model (bottom).**

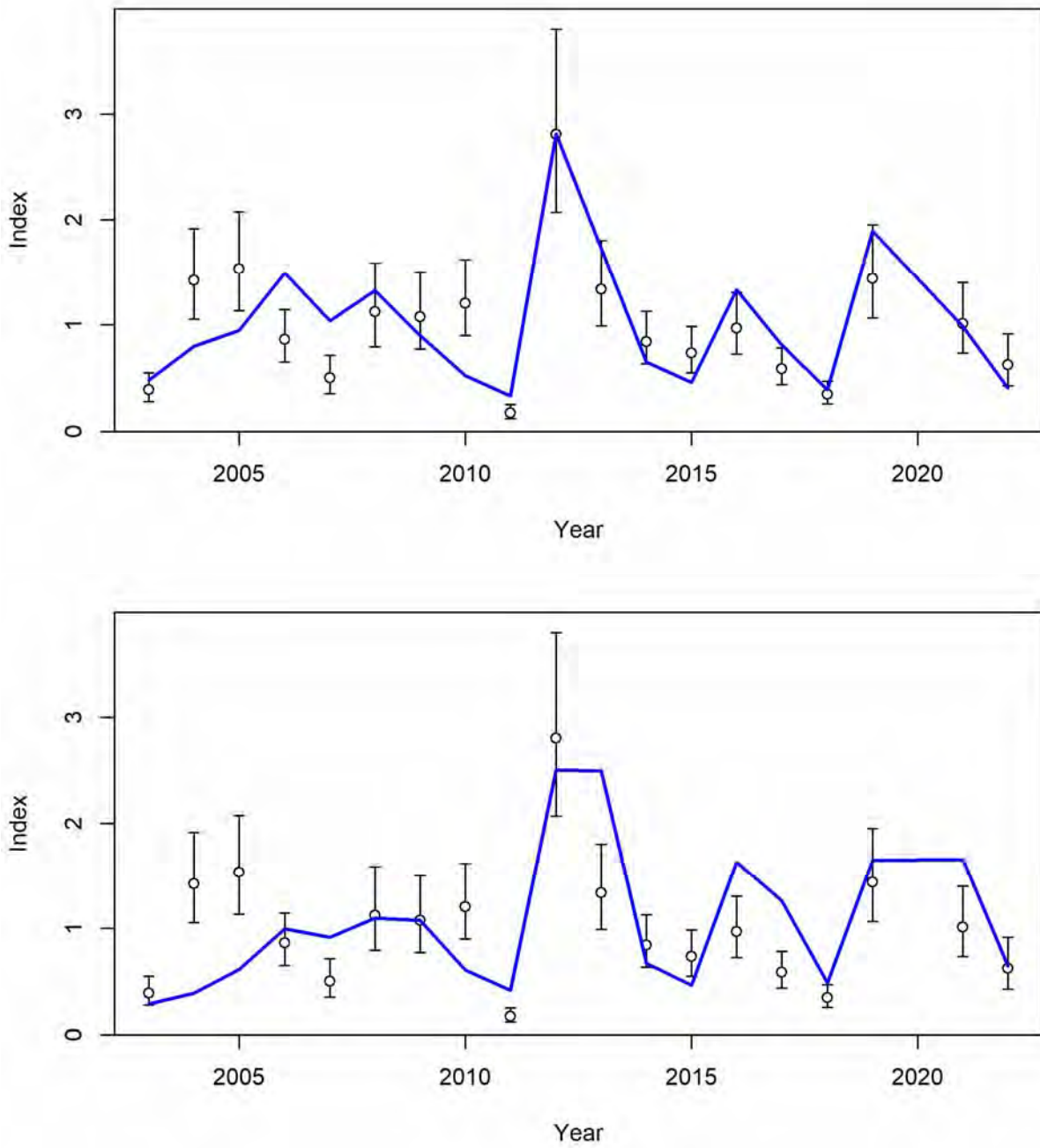




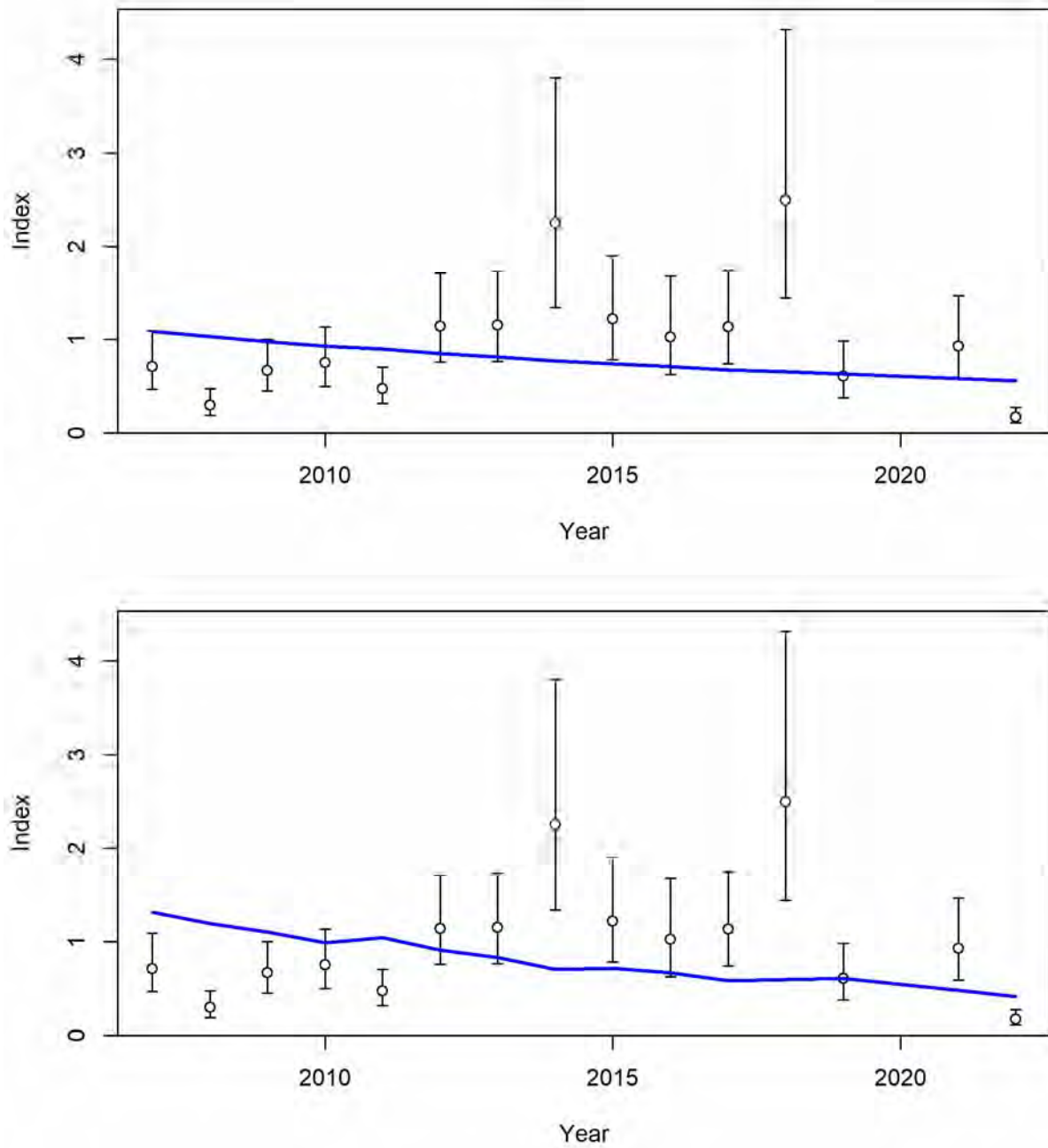
**Figure 131. Observed and estimated discards (in 1000's of fish) for the recreational fleet for the northern stock SS estimated selectivity model (top) and hybrid selectivity model (bottom).**



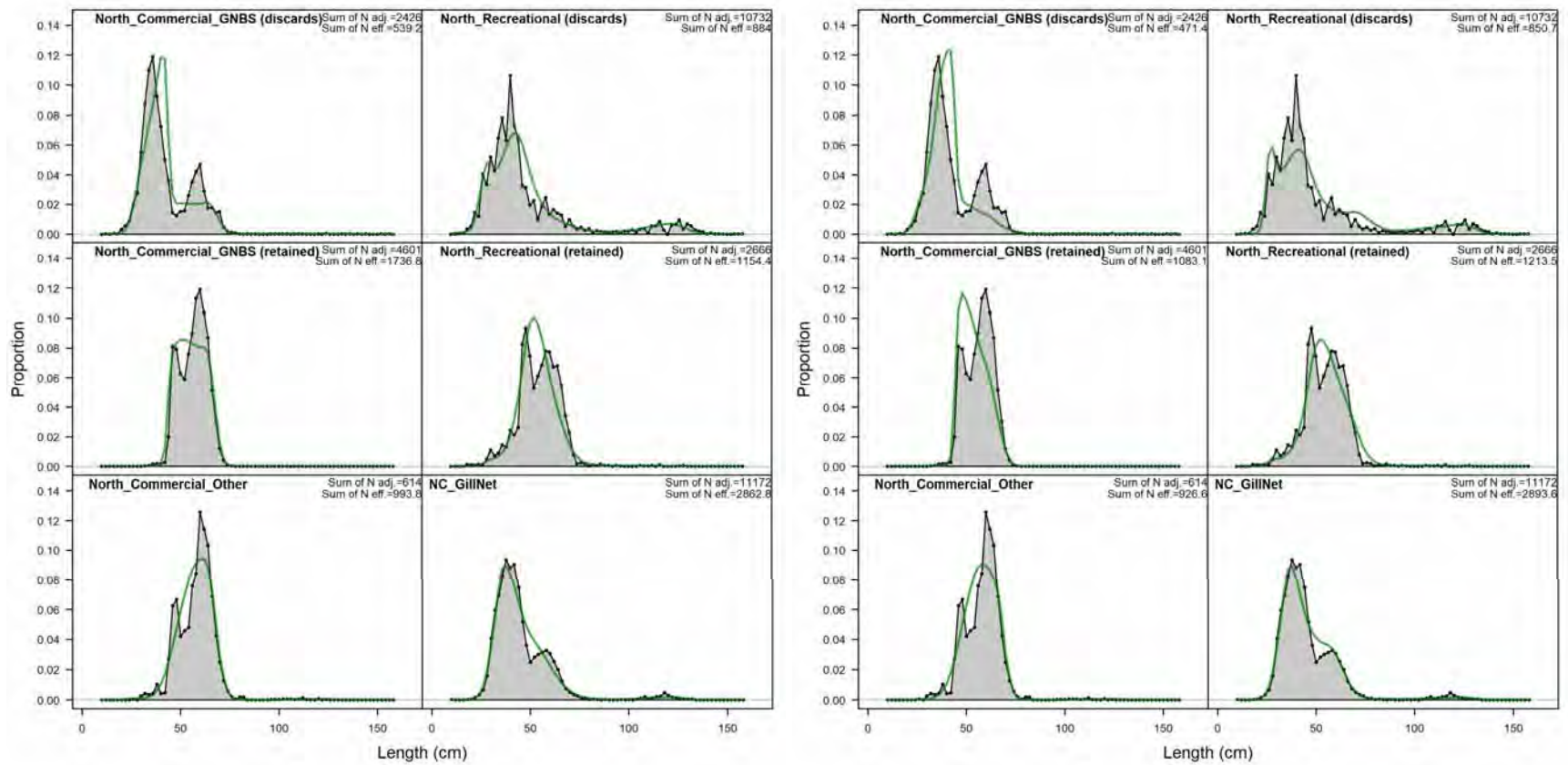
**Figure 132.** Observed and estimated index values for the NC\_BagSeine survey for the northern stock SS estimated selectivity model (top) and hybrid selectivity model (bottom).



**Figure 133.** Observed and estimated index values for the NC\_GillNet survey for the northern stock SS estimated selectivity model (top) and hybrid selectivity model (bottom).

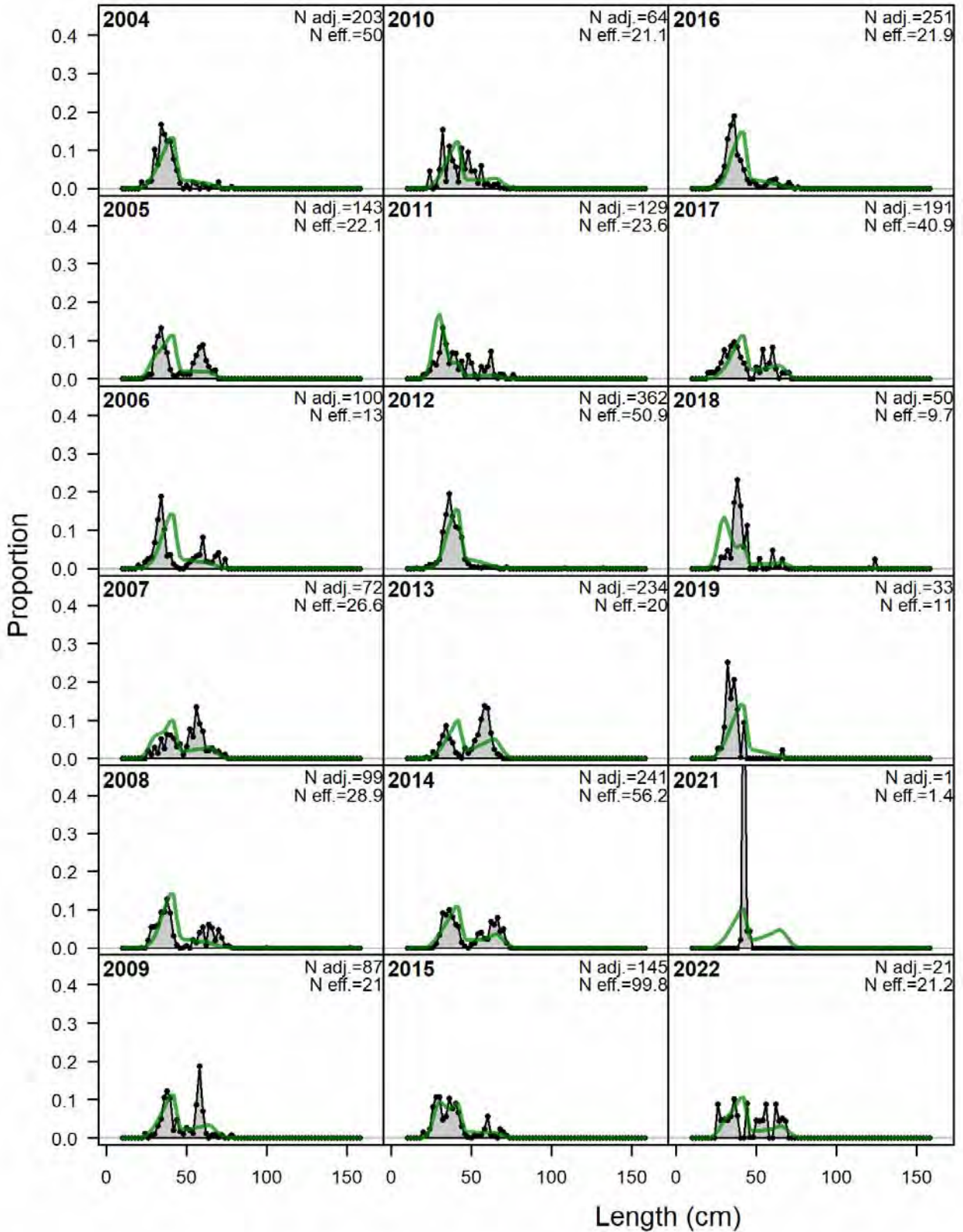


**Figure 134. Observed and estimated index values for the NC\_Longline survey for the northern stock SS estimated selectivity model (top) and hybrid selectivity model (bottom).**

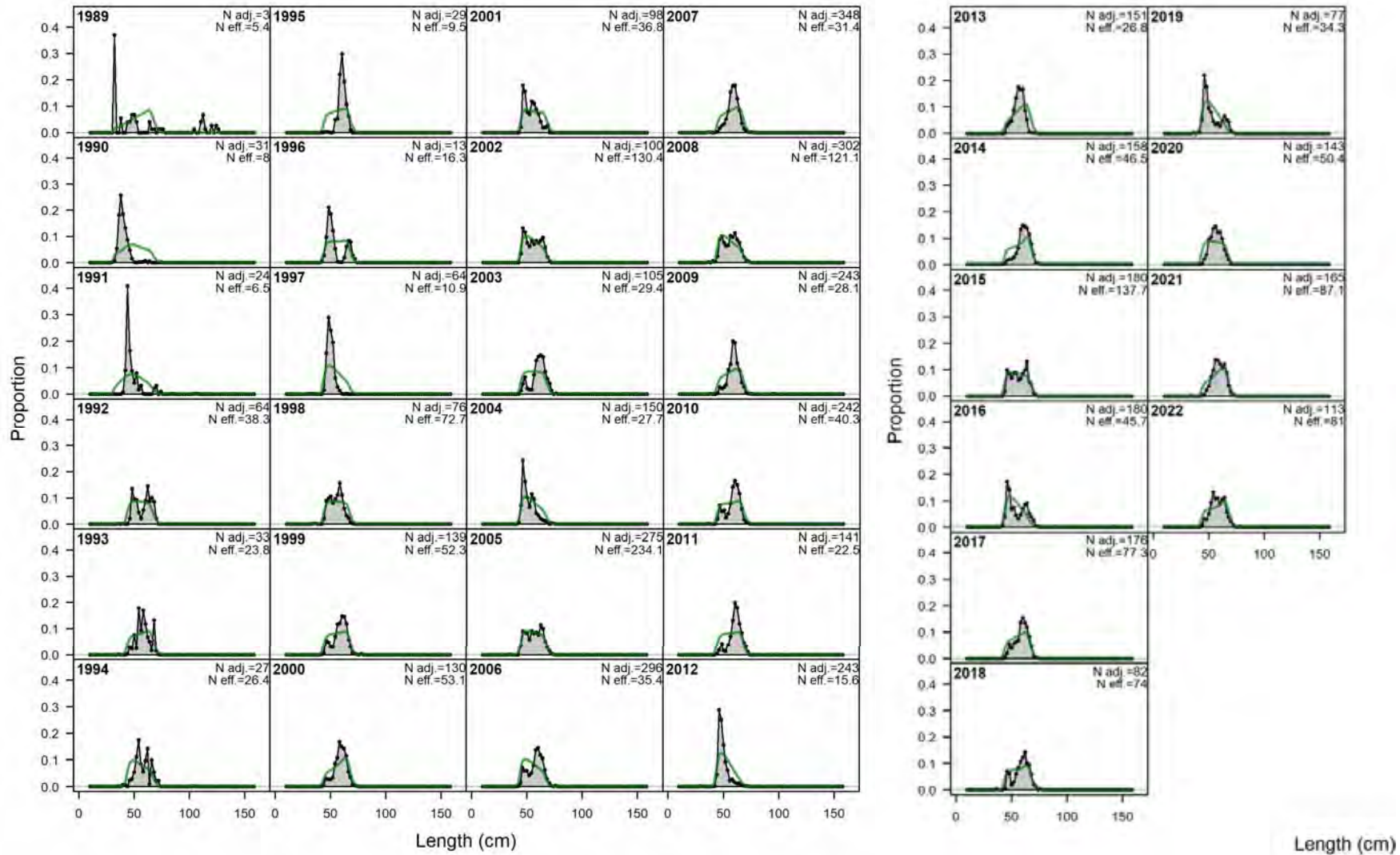


**Figure 135. Length compositions, aggregated across time by fleet/survey for the northern stock SS estimated selectivity model (left) and hybrid selectivity model (right).**

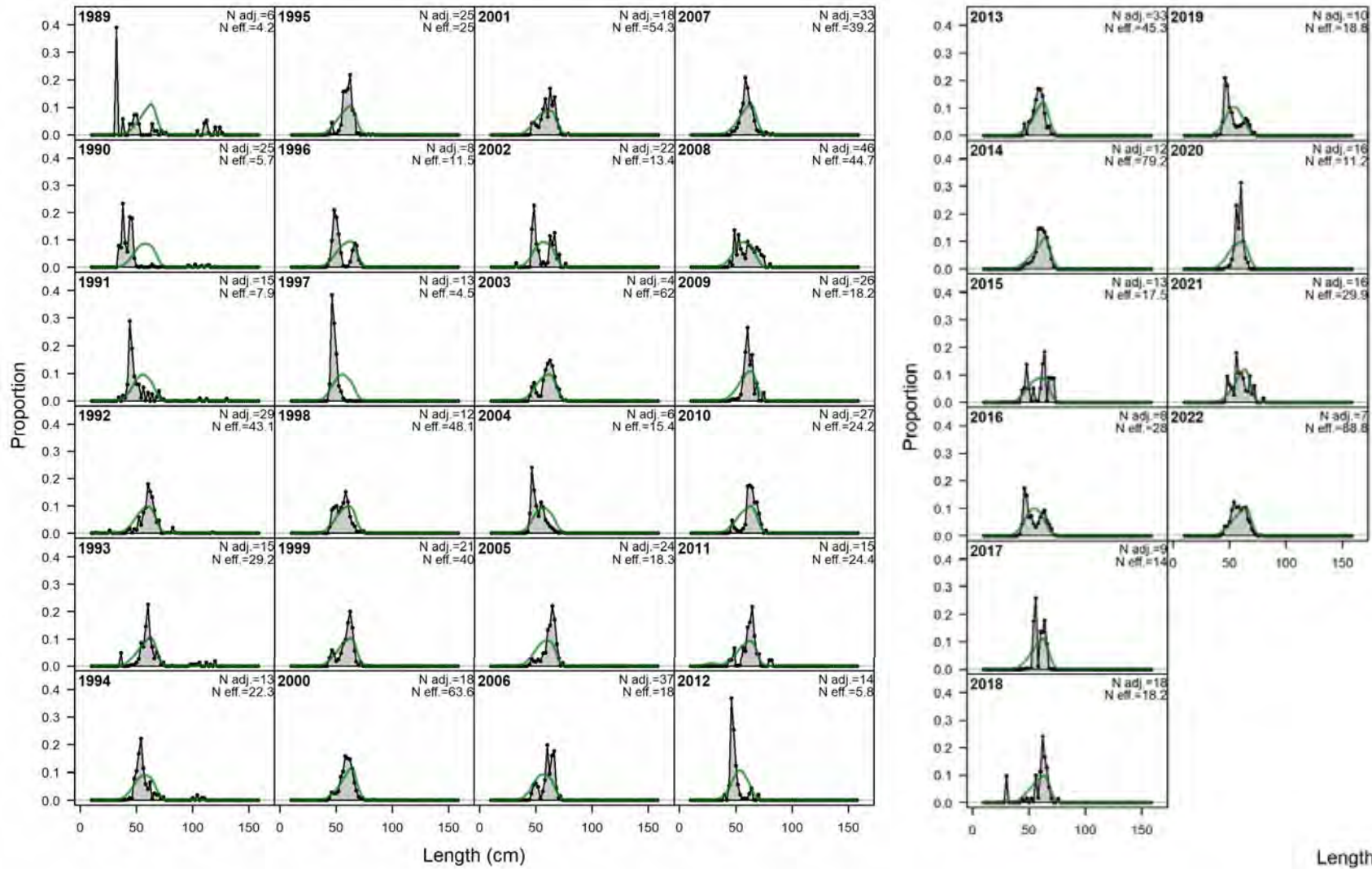




**Figure 136. Annual length compositions for the North\_Commercial\_GNBS discards for the northern stock SS estimated selectivity model.**

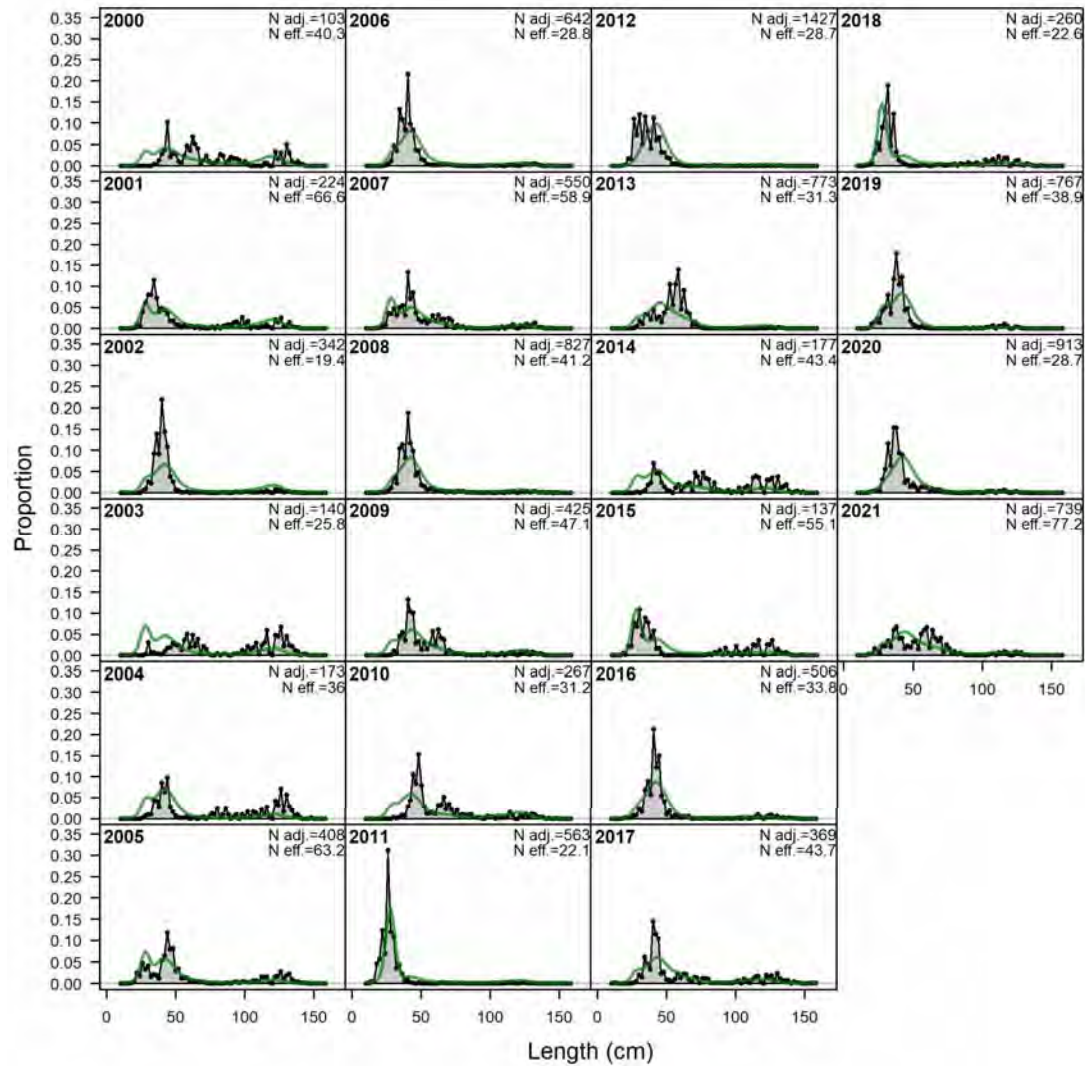


**Figure 137. Annual length compositions for the North\_Commercial\_GNBS harvest for the northern stock SS estimated selectivity model.**

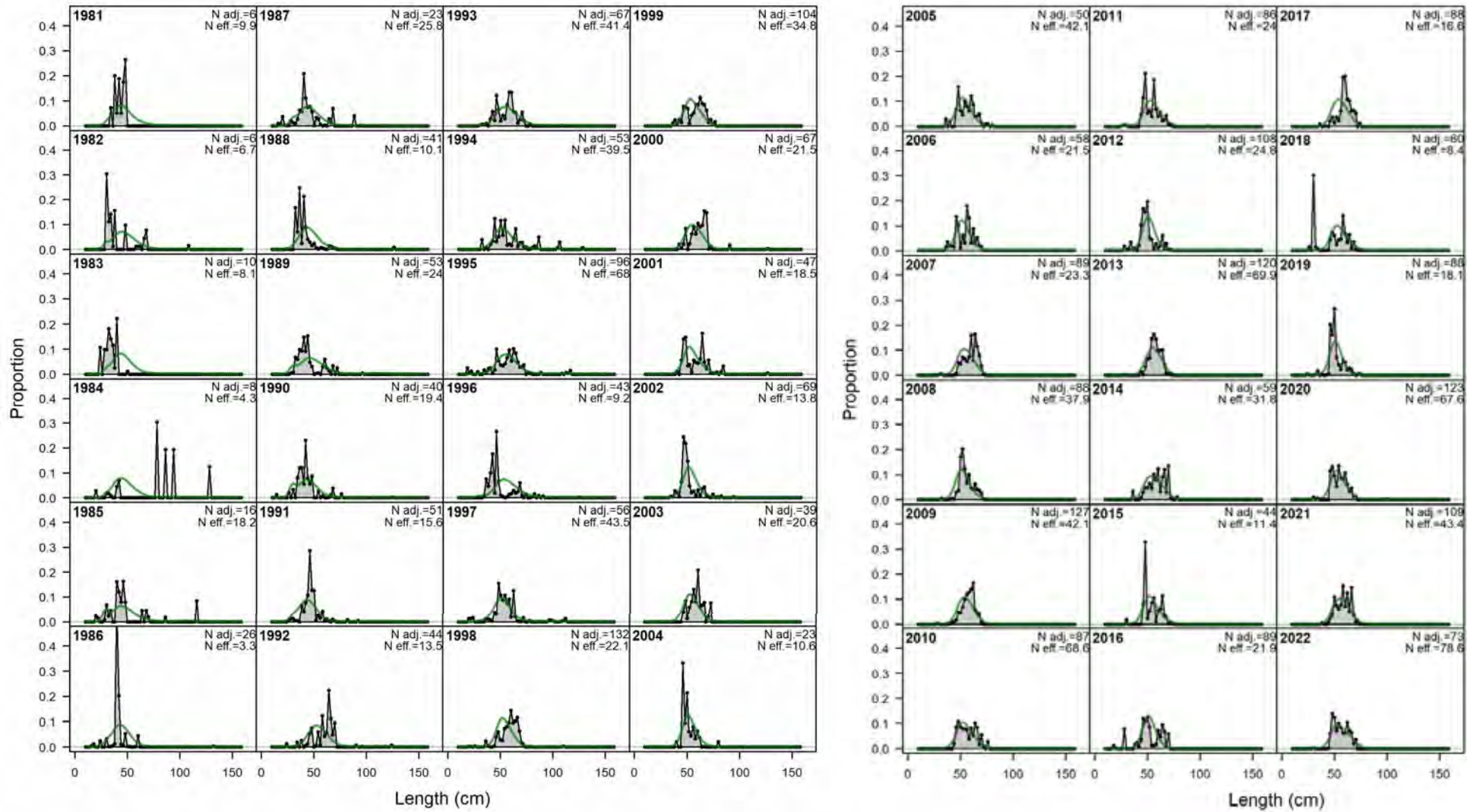


**Figure 138. Annual length compositions for the North\_Commercial\_Other harvest for the northern stock SS estimated selectivity model.**

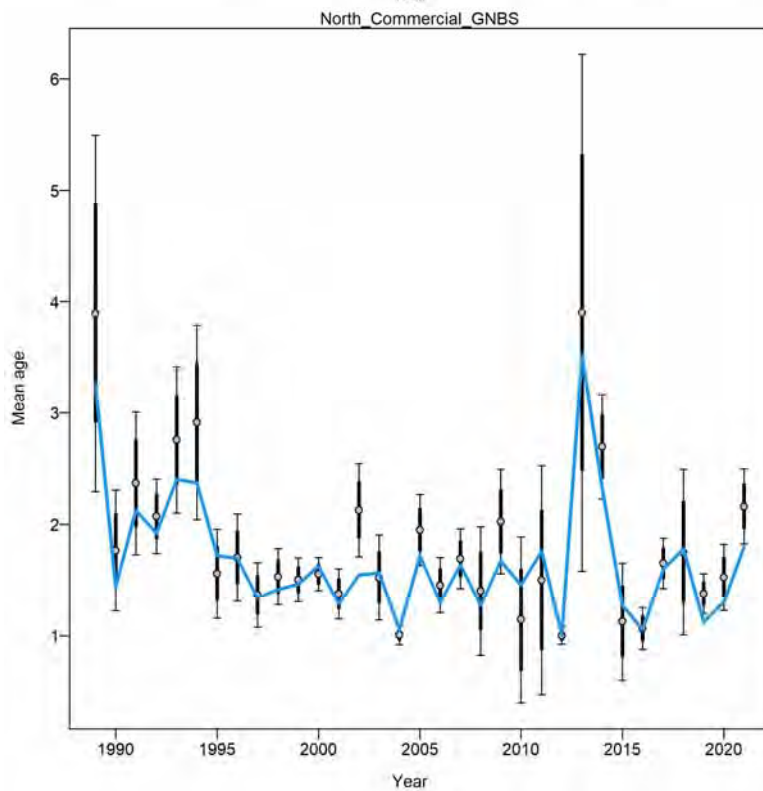
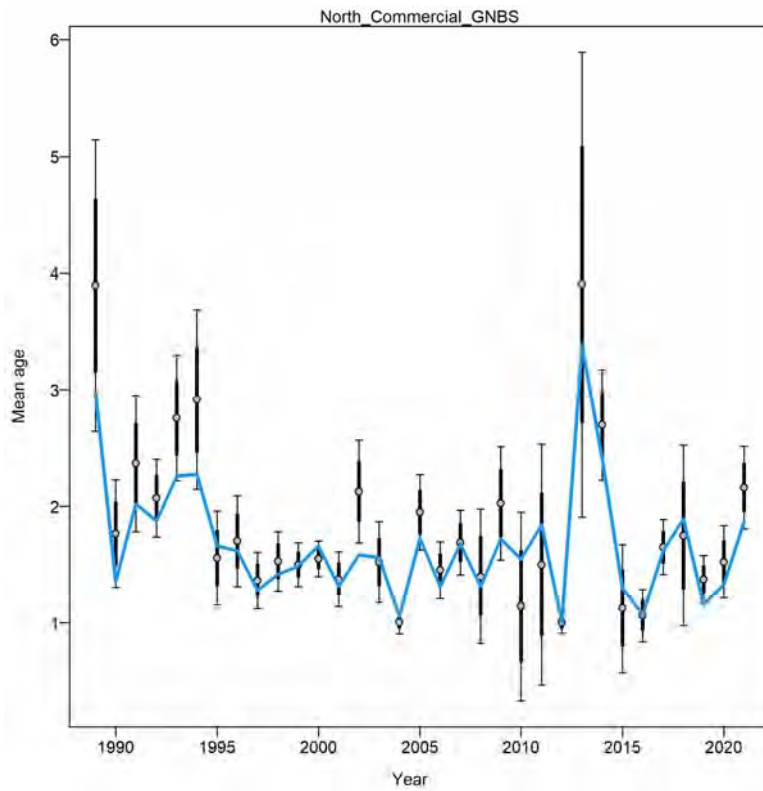




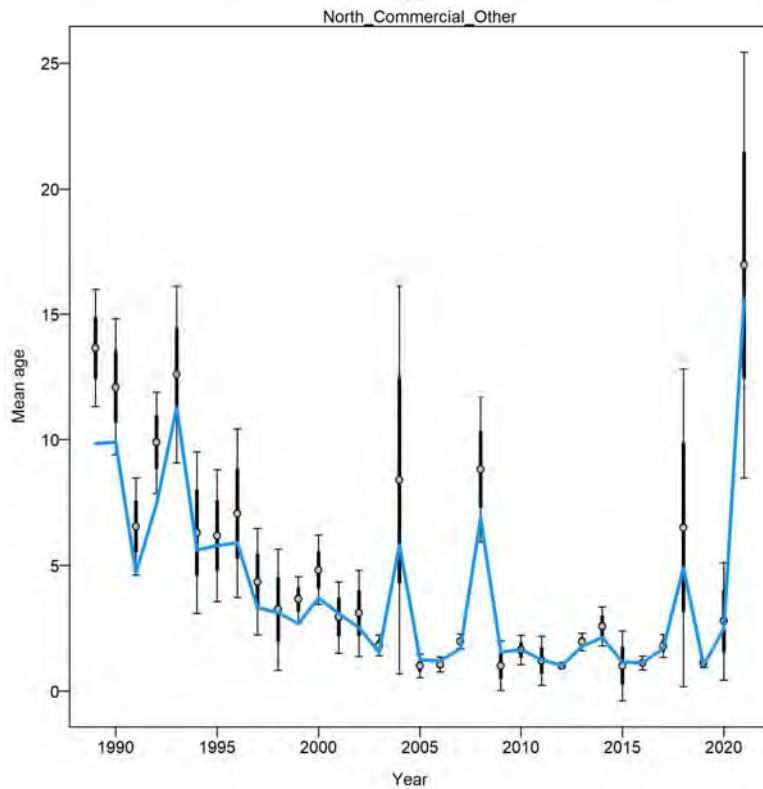
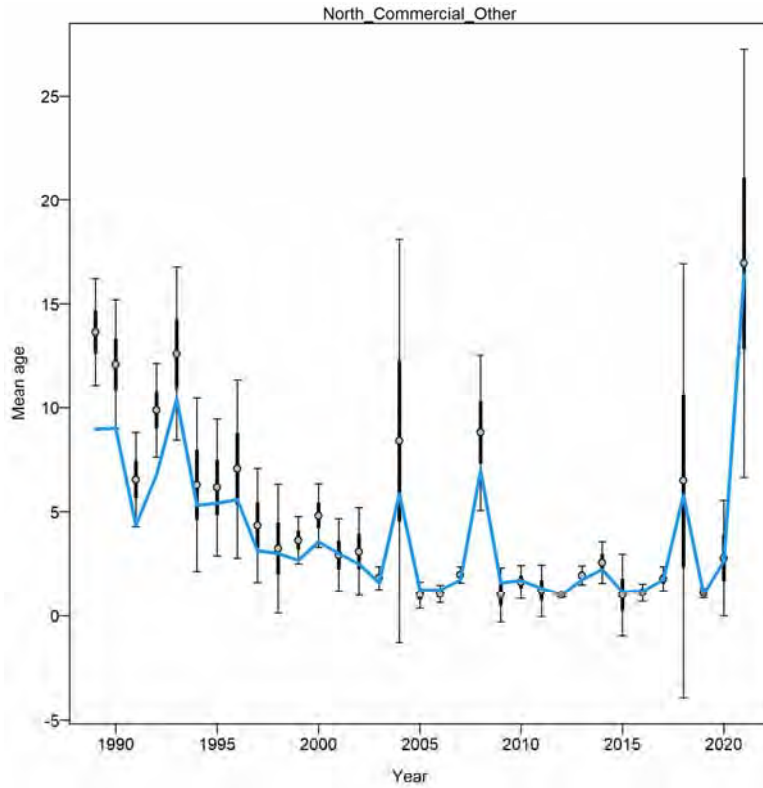
**Figure 139. Annual length compositions for the North\_Recreational discards for the northern stock SS estimated selectivity model.**



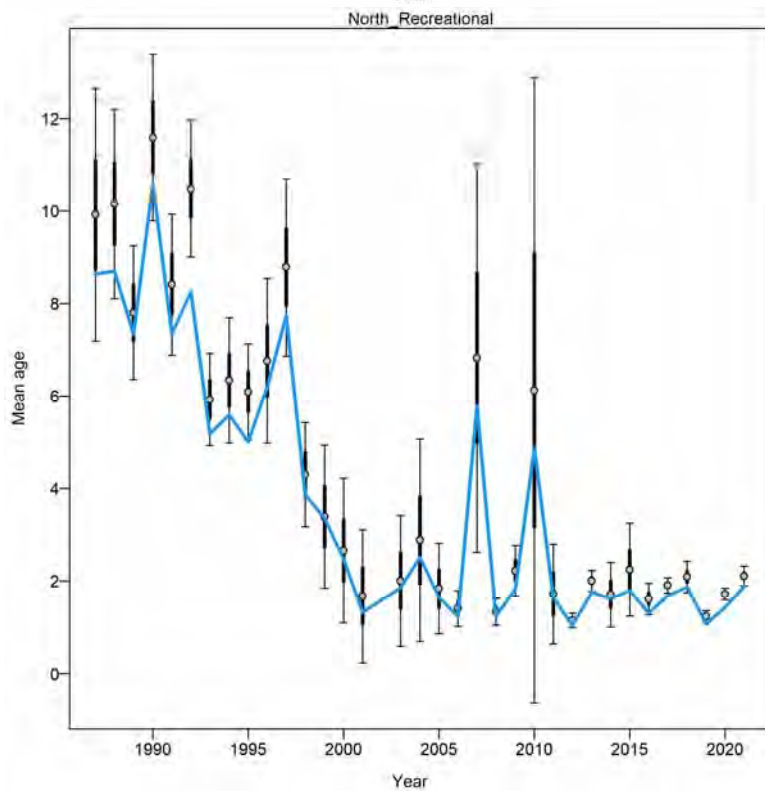
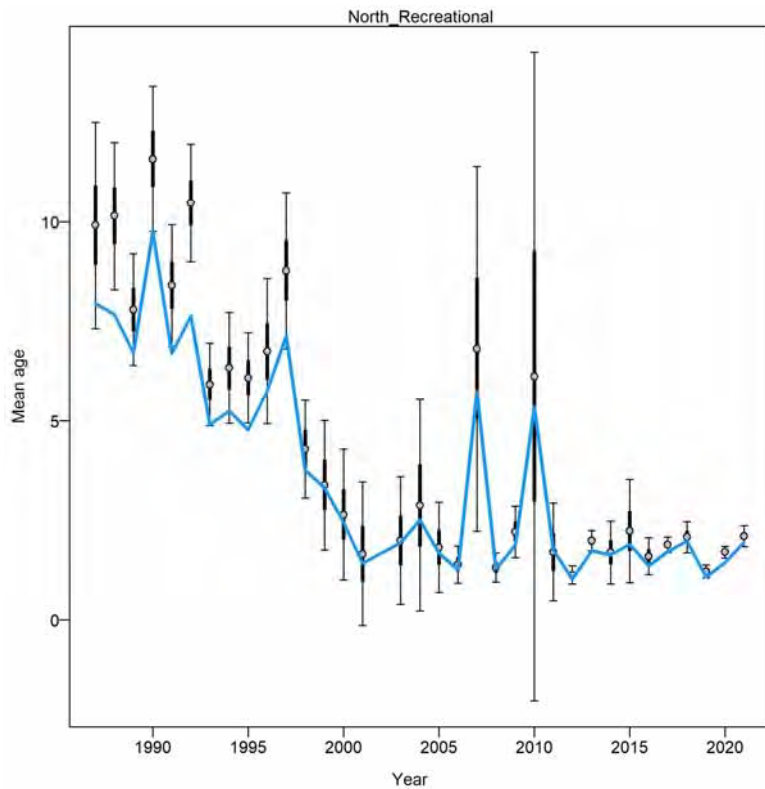
**Figure 140. Annual length compositions for the North\_Recreational harvest for the northern stock SS estimated selectivity model.**



**Figure 141. Mean age from the conditional age data for the North\_Commercial\_GNBS fleet for the northern stock SS estimated selectivity model (top) and hybrid selectivity model (bottom).**

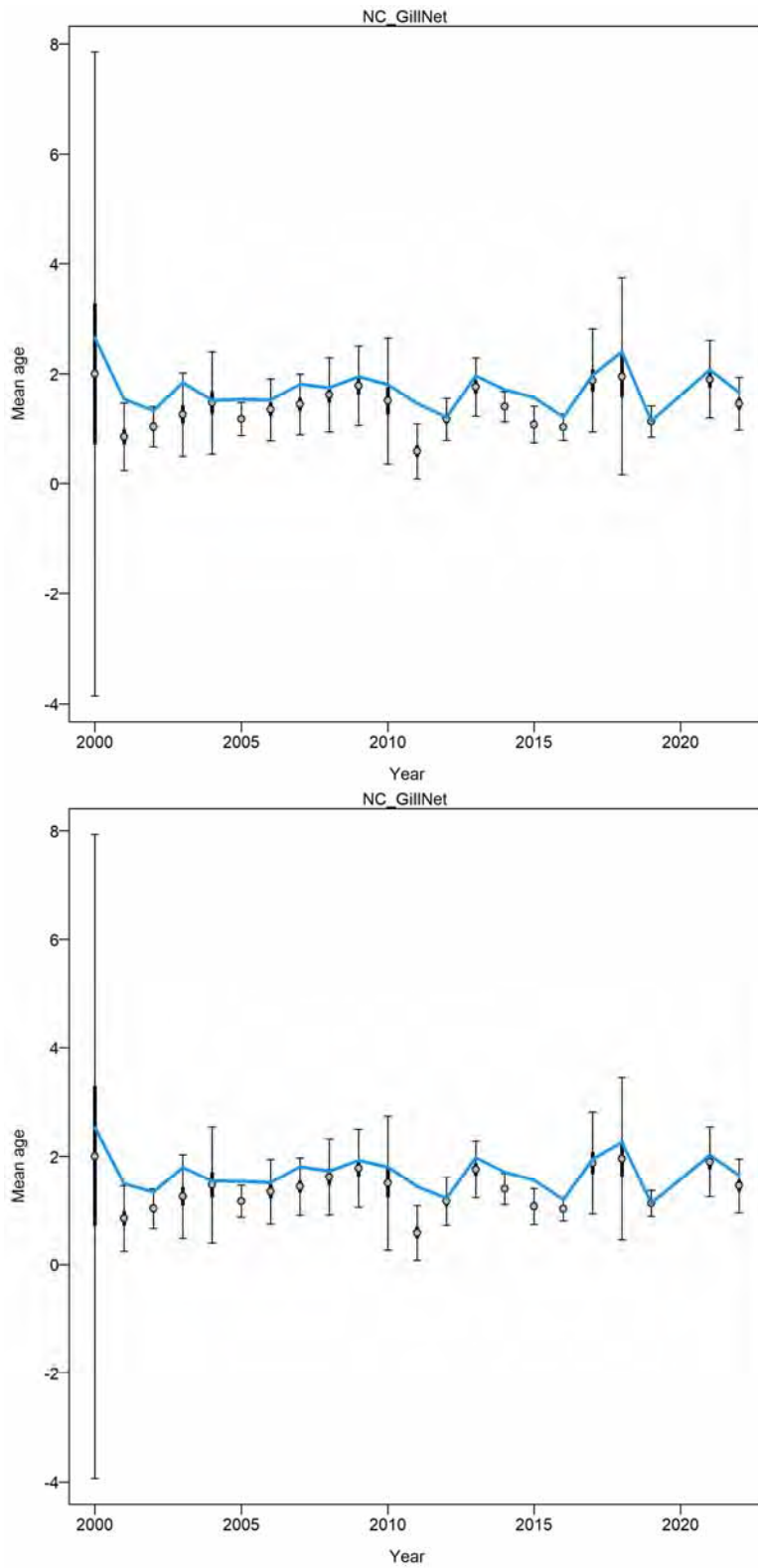


**Figure 142. Mean age from the conditional age data for the North\_Commercial\_Other fleet for the northern stock SS estimated selectivity model (top) and hybrid selectivity model (bottom).**

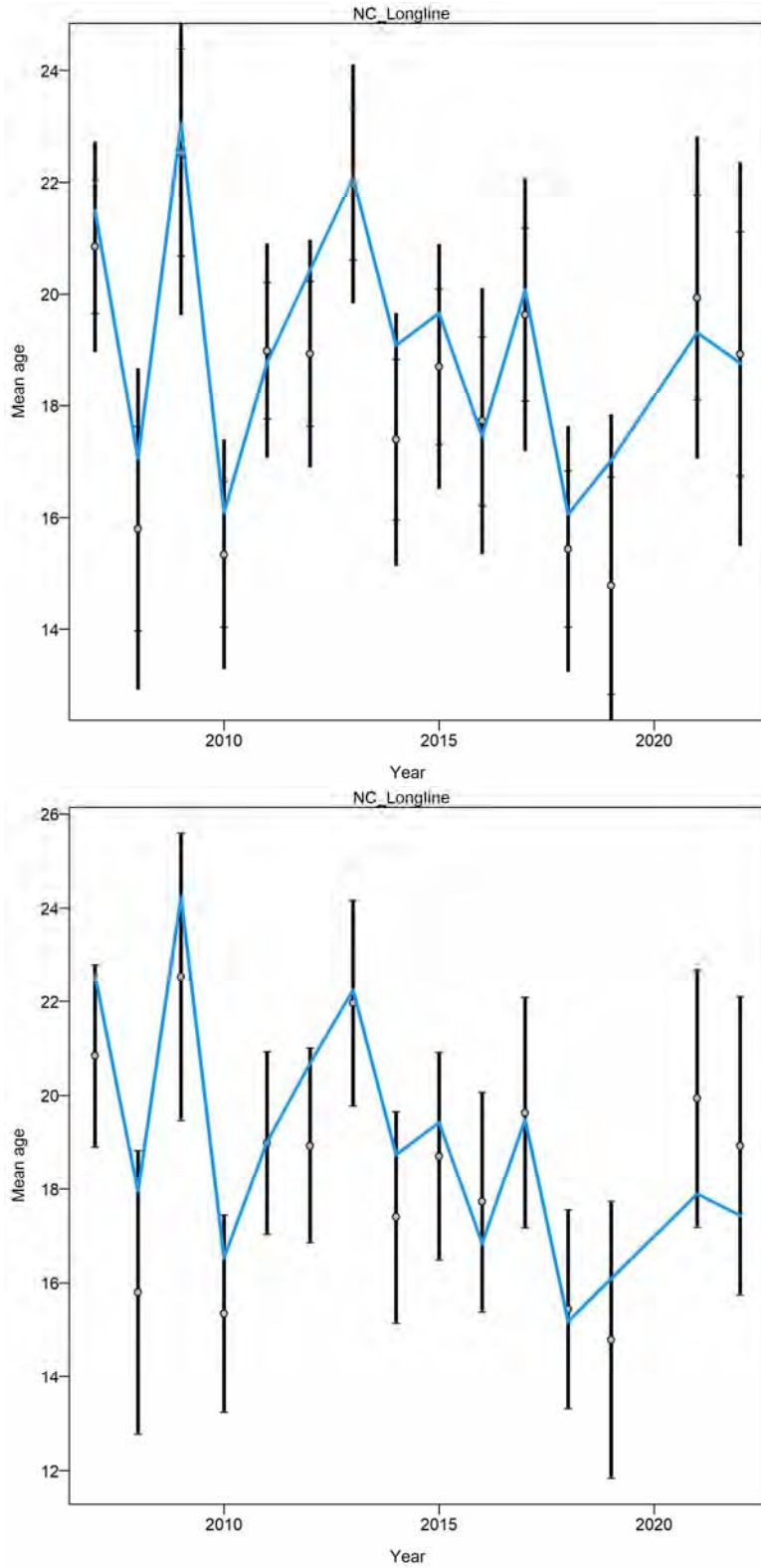


**Figure 143.** Mean age from the conditional age data for the North\_Recreational fleet for the northern stock SS estimated selectivity model (top) and hybrid selectivity model (bottom).

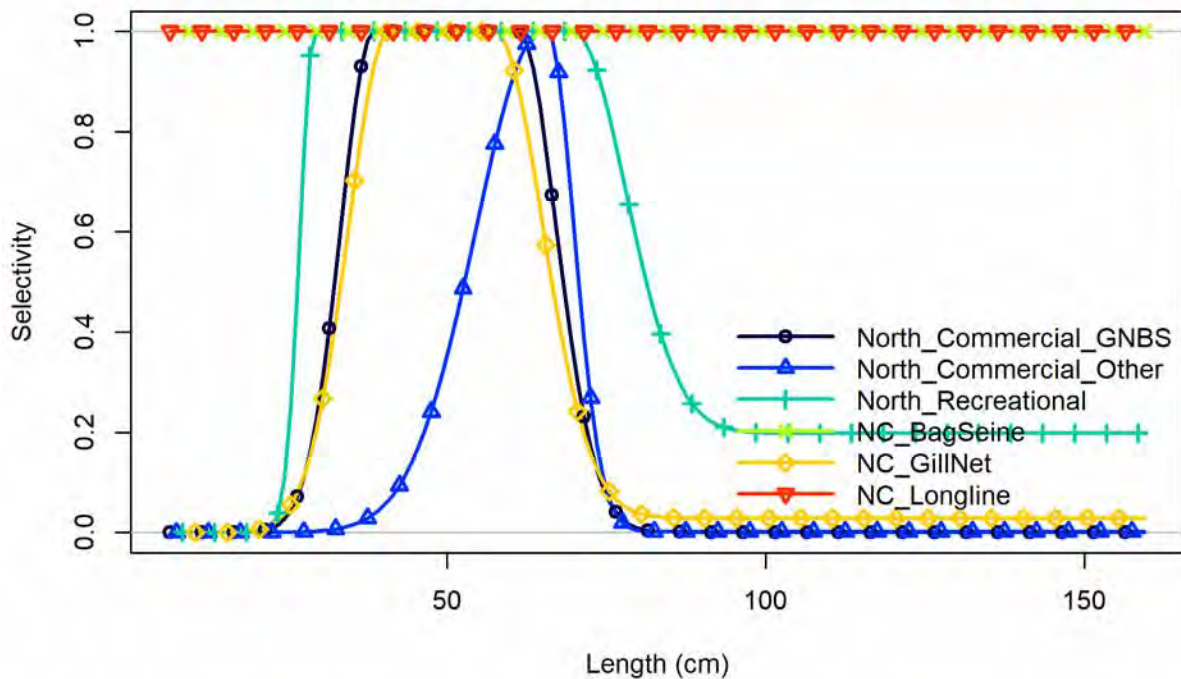
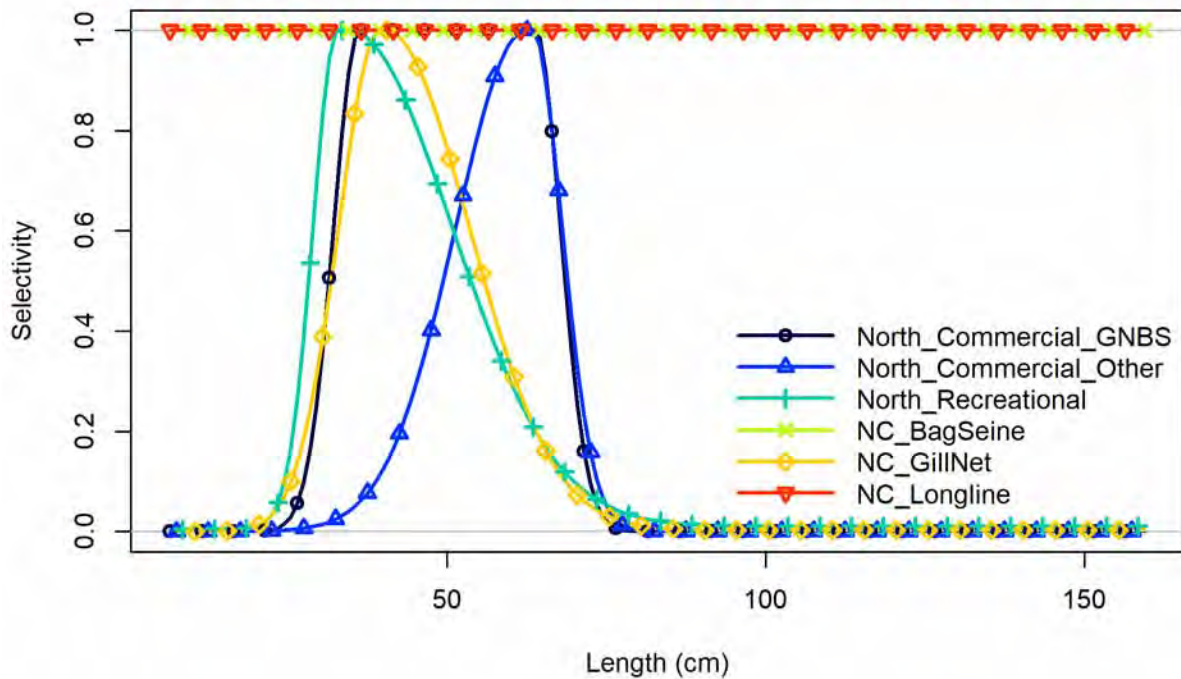




**Figure 144.** Mean age from the conditional age data for the NC\_GillNet survey for the northern stock SS estimated selectivity model (top) and hybrid selectivity model (bottom).



**Figure 145. Mean age from the conditional age data for the NC\_Longline survey for the northern stock SS estimated selectivity model (top) and hybrid selectivity model (bottom).**



**Figure 146.** Estimated length based selectivities for the northern stock SS estimated selectivity model (top) and hybrid selectivity model (bottom). The North\_Commercial\_GNBS and North\_Recreational selectivities are fixed in the hybrid selectivity model.



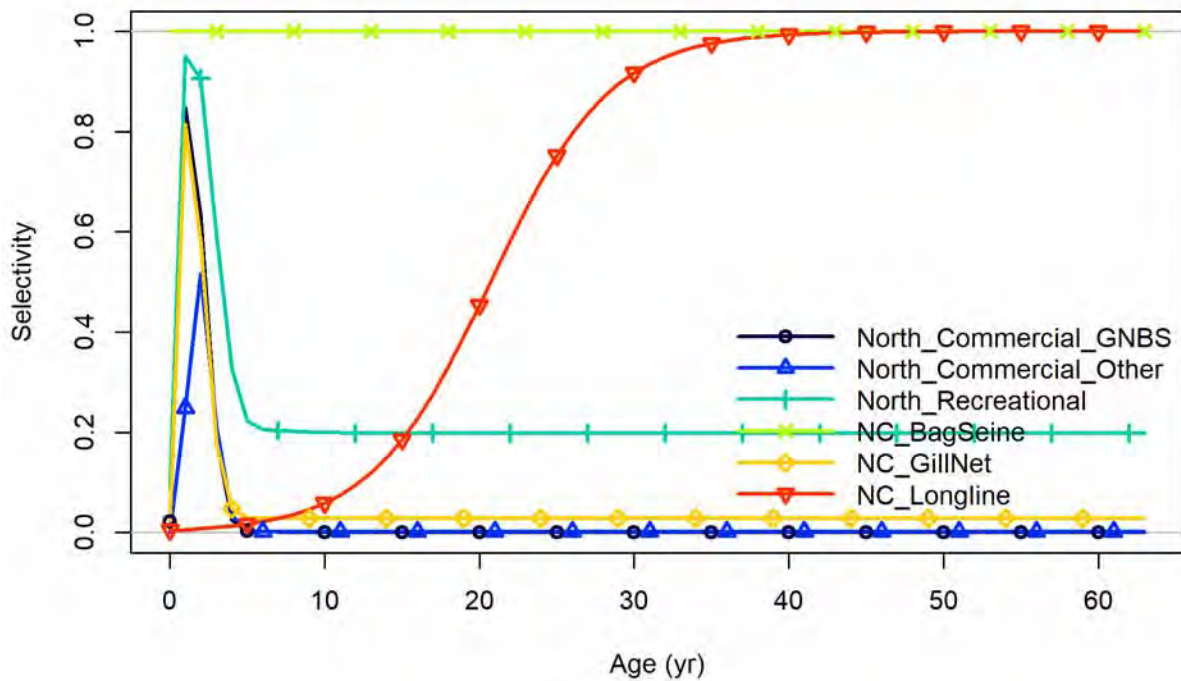
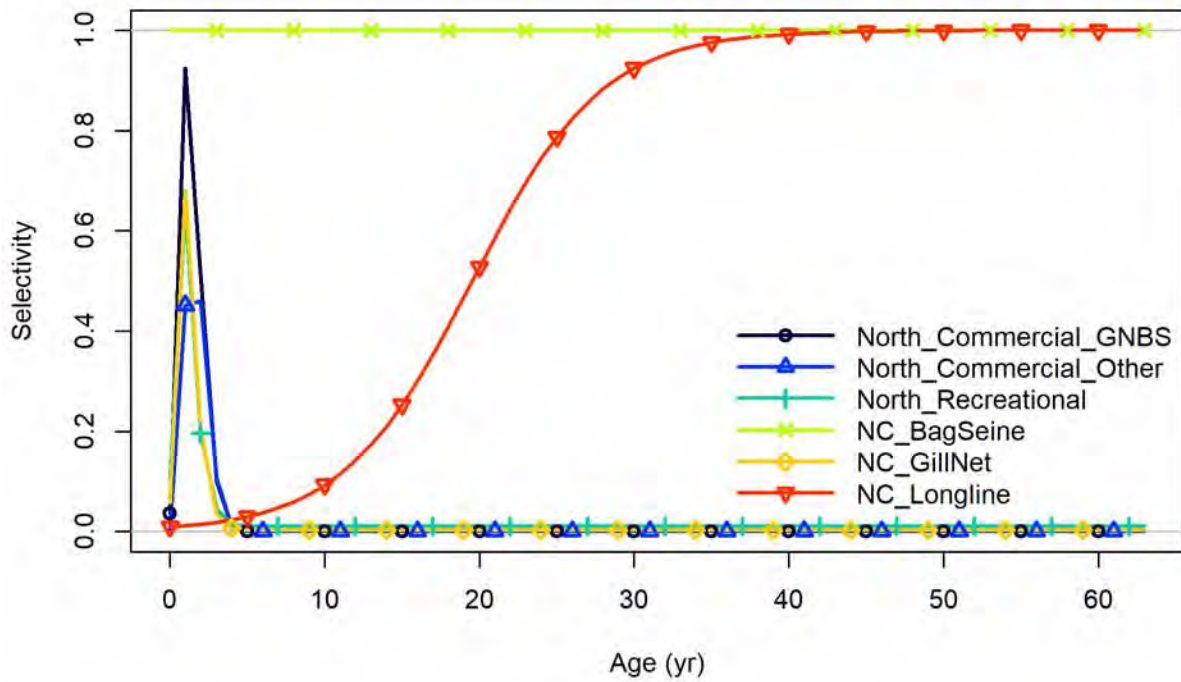
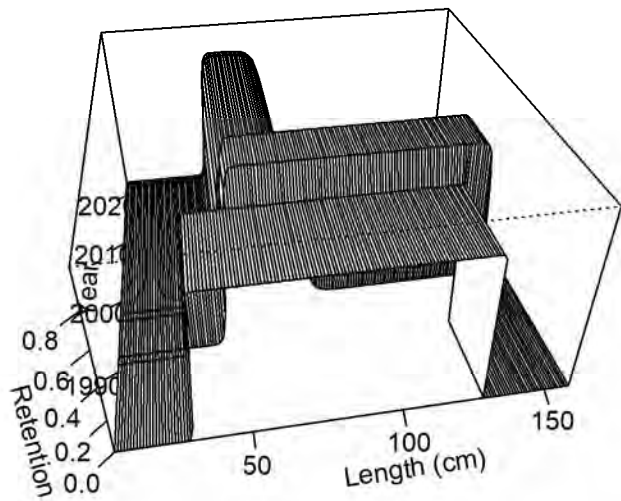
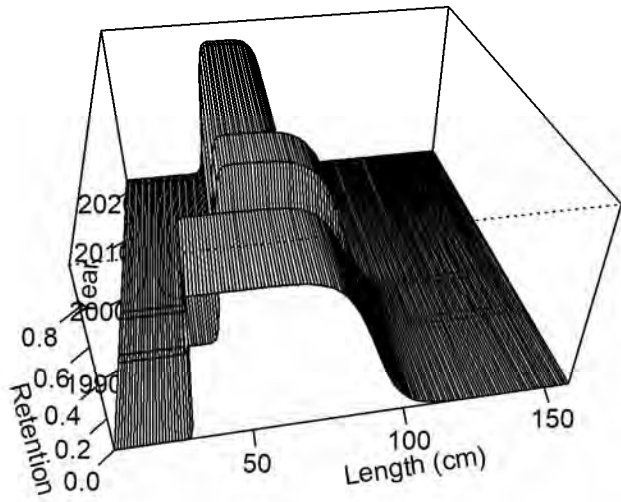
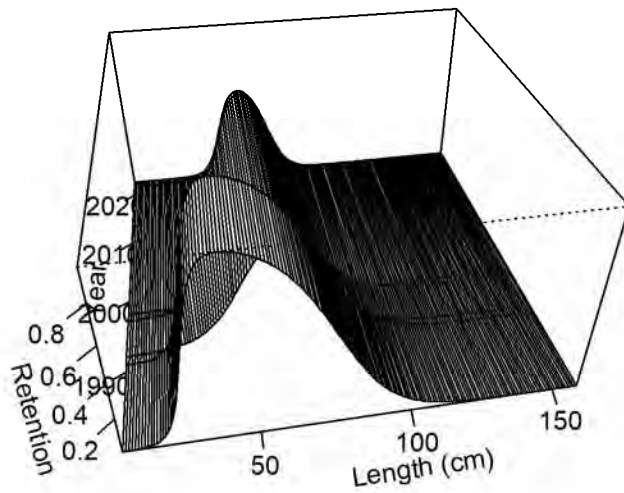
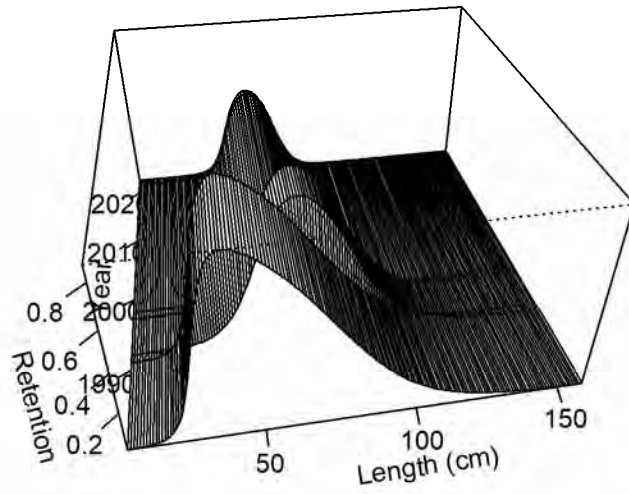


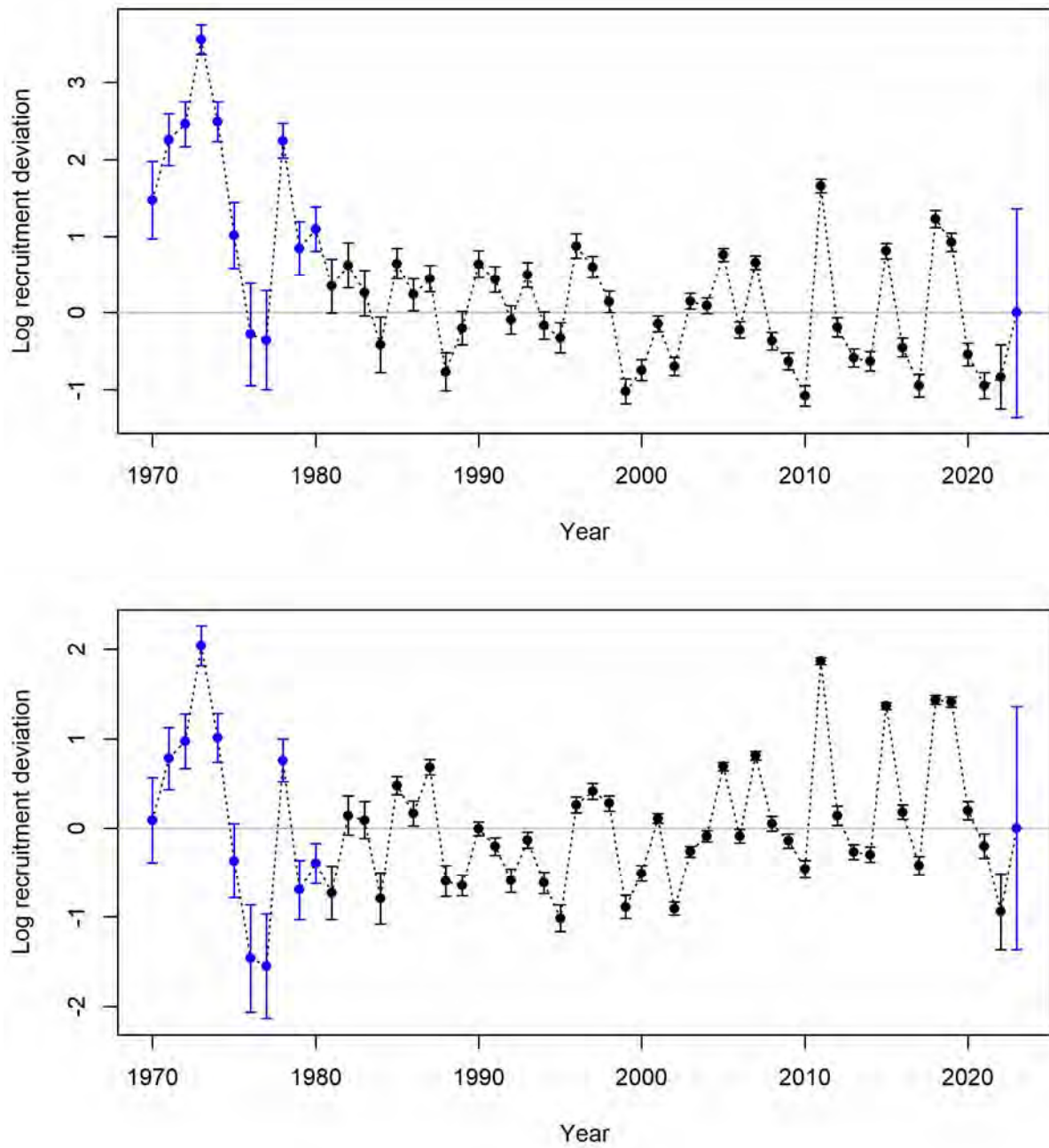
Figure 147. Estimated age based selectivity for the NC\_Longline survey with derived age based selectivities for the other fleets for the northern stock SS estimated selectivity model (top) and hybrid selectivity model (bottom).



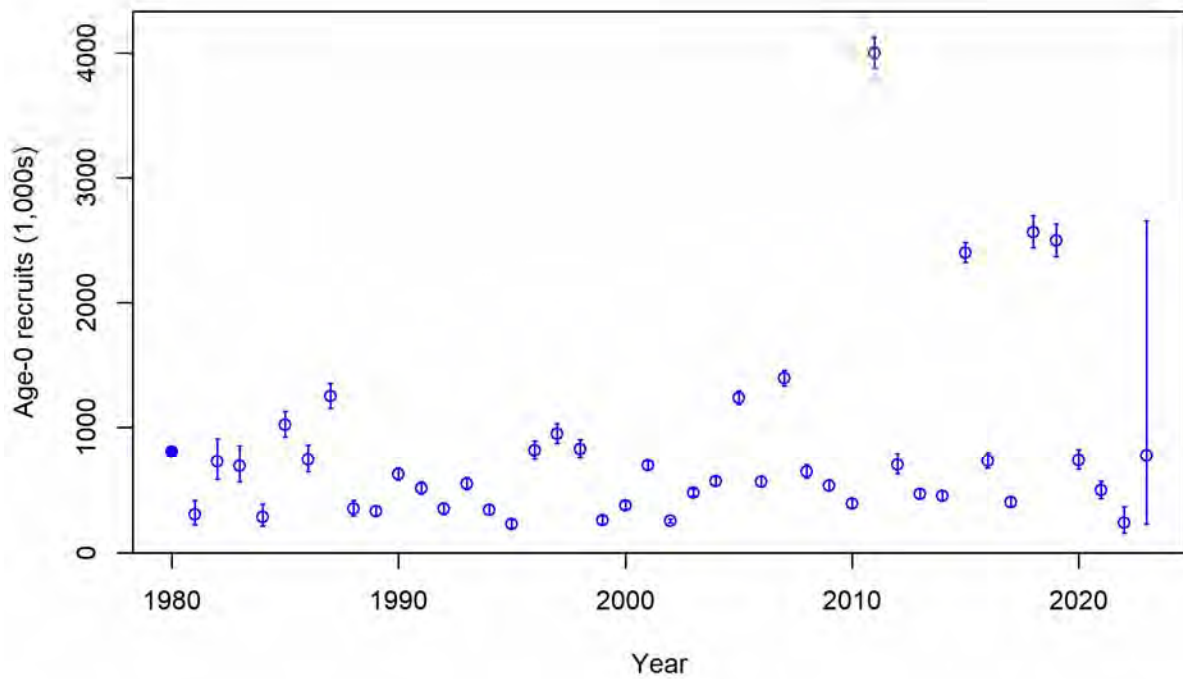
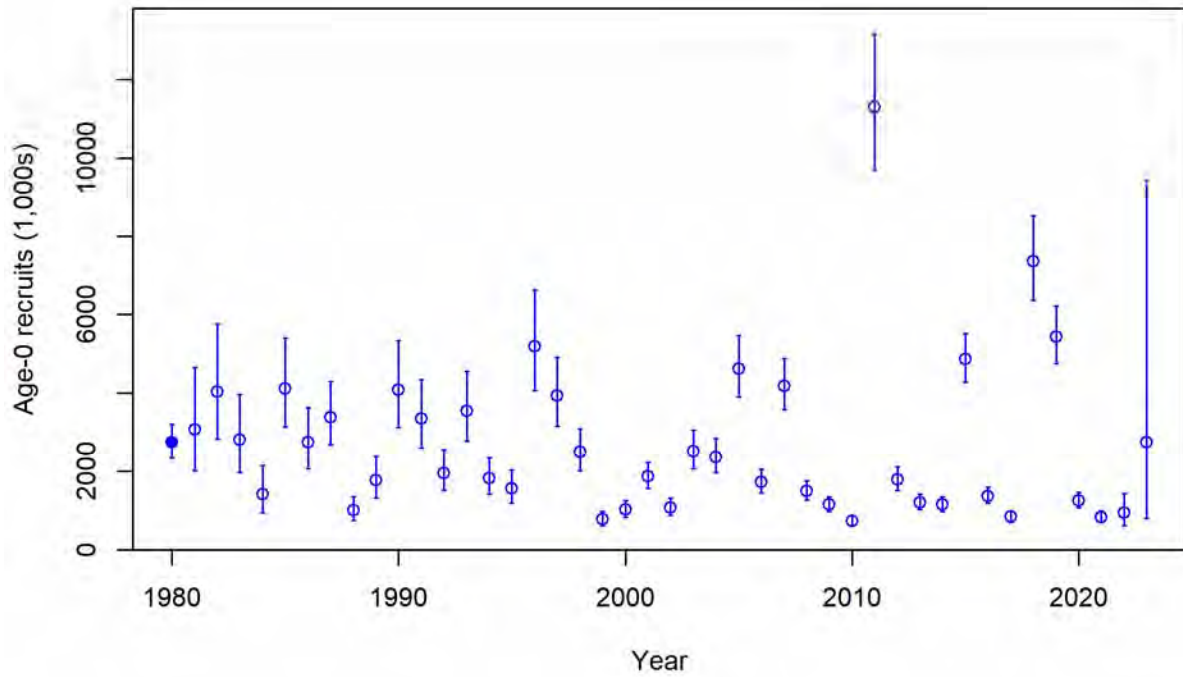
**Figure 148. Retention estimates, by regulatory period, for the North\_Commercial\_GNBS fleet for the northern stock SS estimated selectivity model (top) and hybrid selectivity model (bottom).**



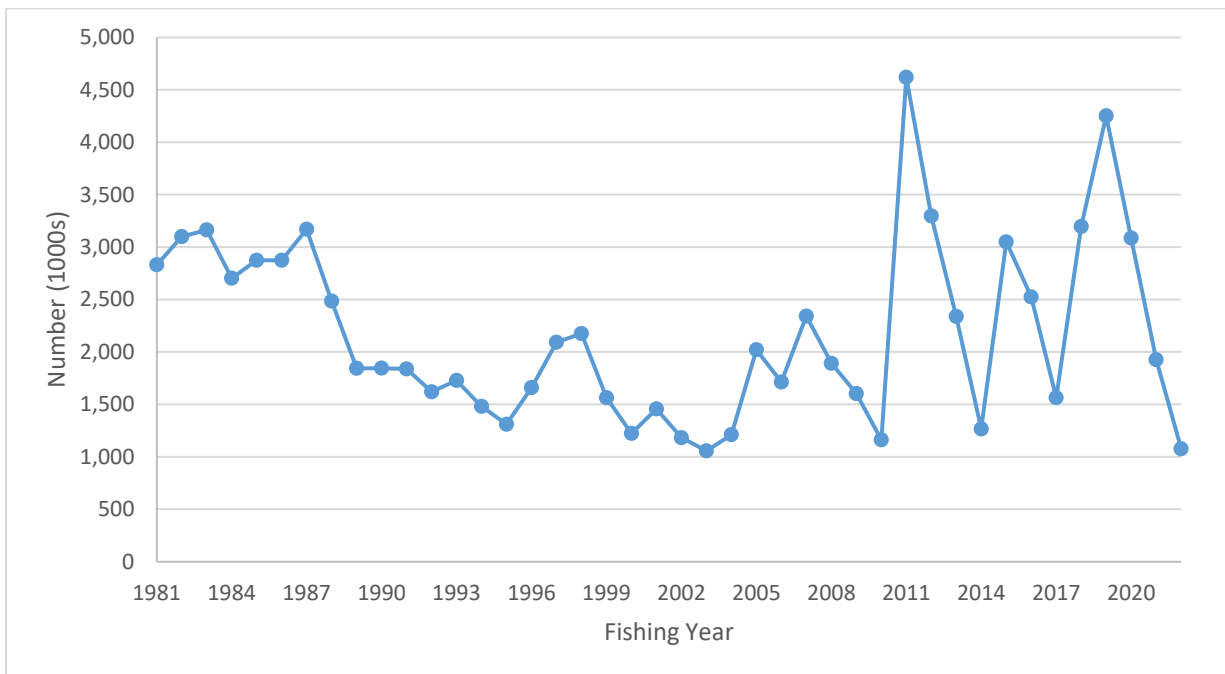
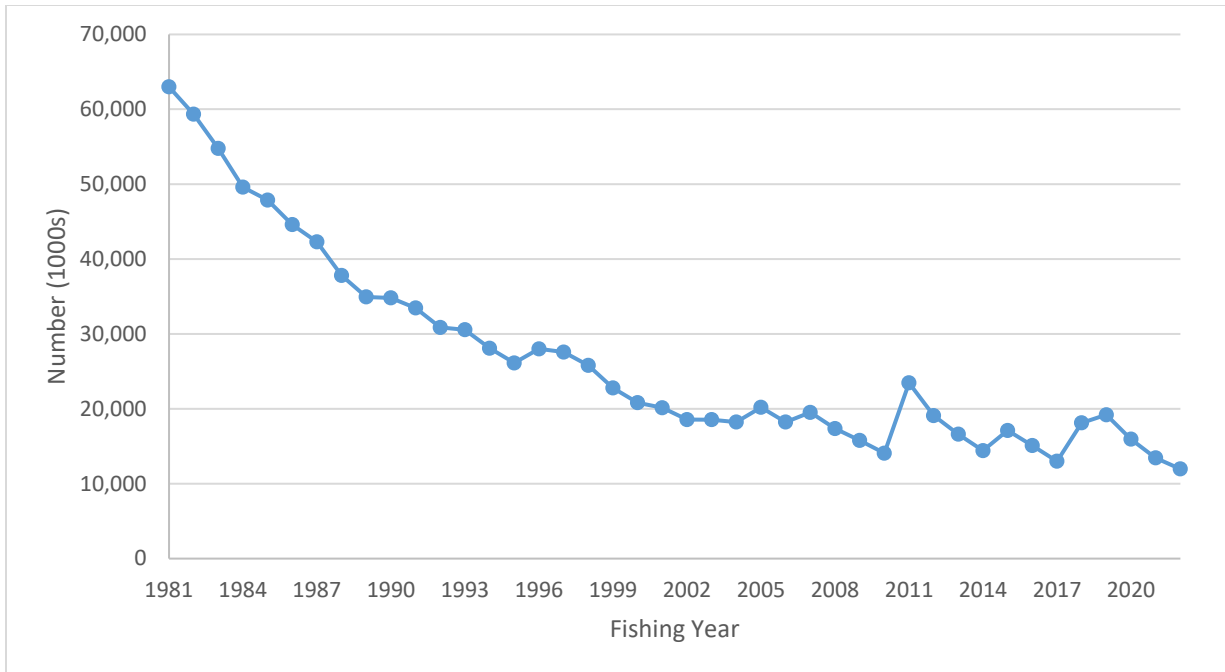
**Figure 149. Retention estimates, by regulatory period, for the North\_Recreational fleet for the northern stock SS estimated selectivity model (top) and hybrid selectivity model (bottom).**



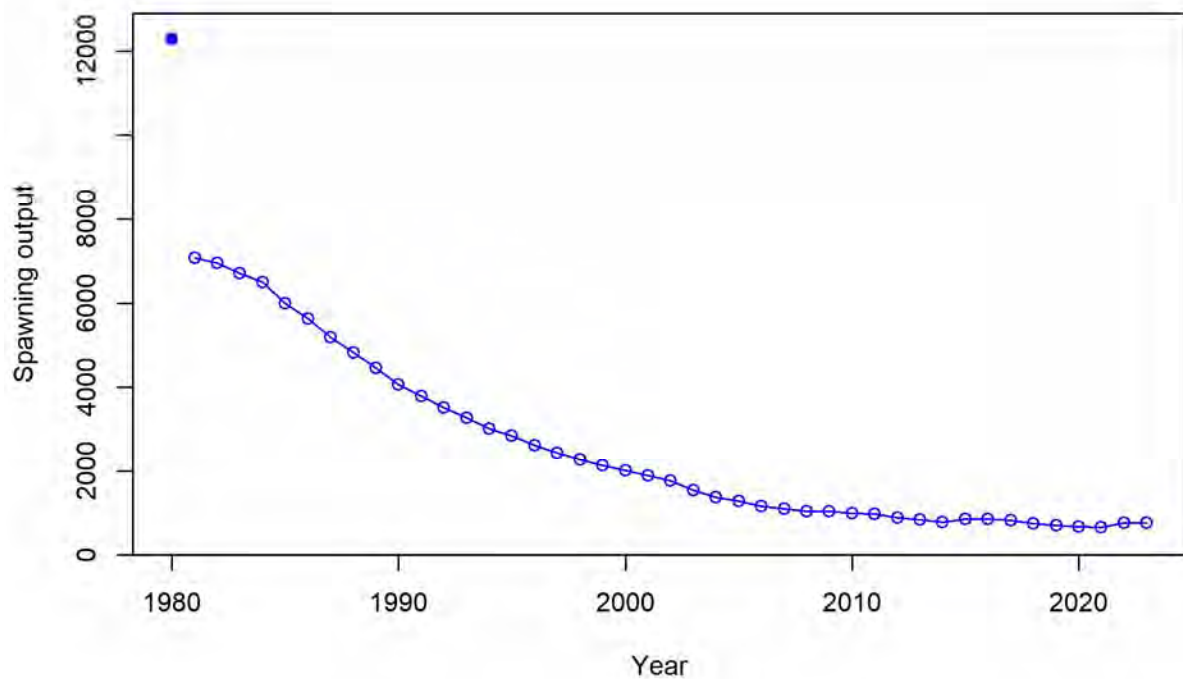
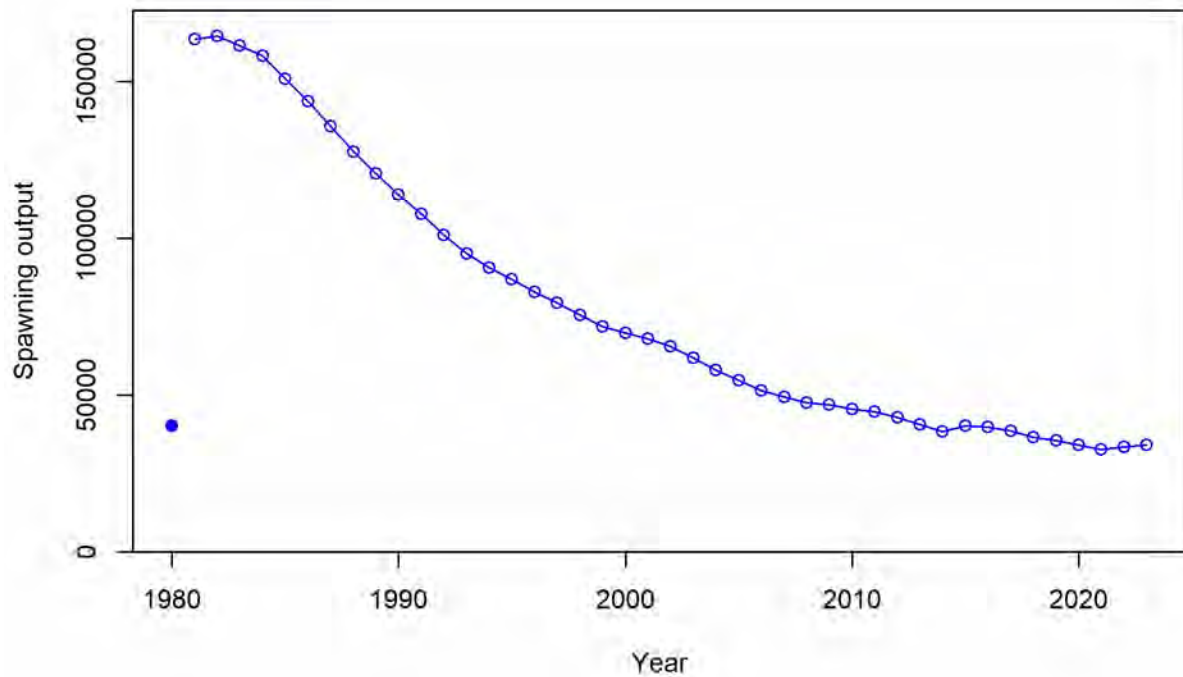
**Figure 150.** Recruitment deviations, with 95% confidence intervals from asymptotic standard errors, for the northern stock SS estimated selectivity model (top) and hybrid selectivity model (bottom).



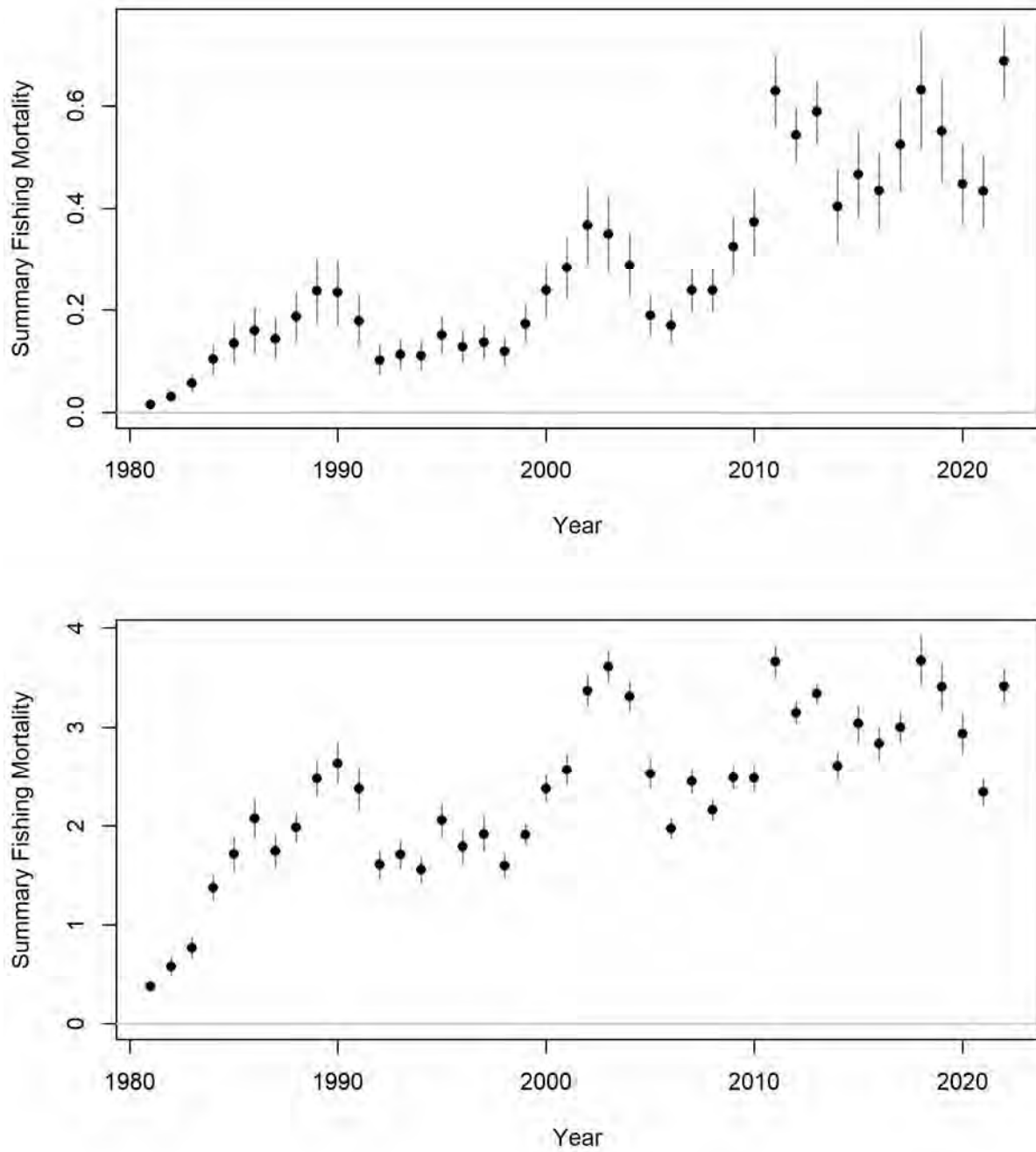
**Figure 151.** Estimated recruitment (in 1000s) for the northern stock SS estimated selectivity model (top) and hybrid selectivity model (bottom). Error bars are 95% confidence intervals based on asymptotic standard errors.



**Figure 152. Estimated population (in 1000s of fish) for the northern stock SS estimated selectivity model (top) and hybrid selectivity model (bottom).**

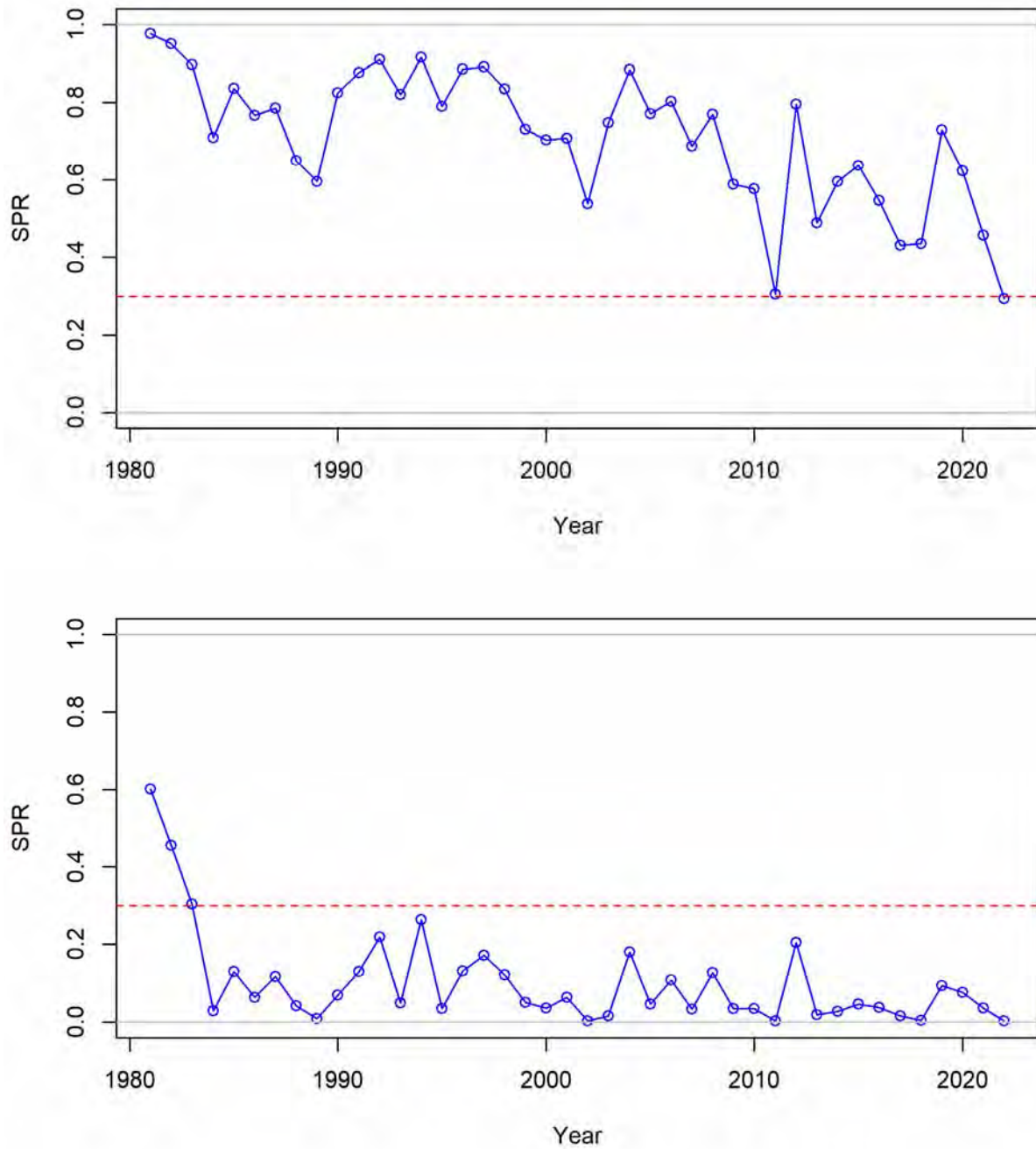


**Figure 153. Estimated female SSB (metric tons) for the northern stock SS estimated selectivity model (top) and hybrid selectivity model (bottom).**

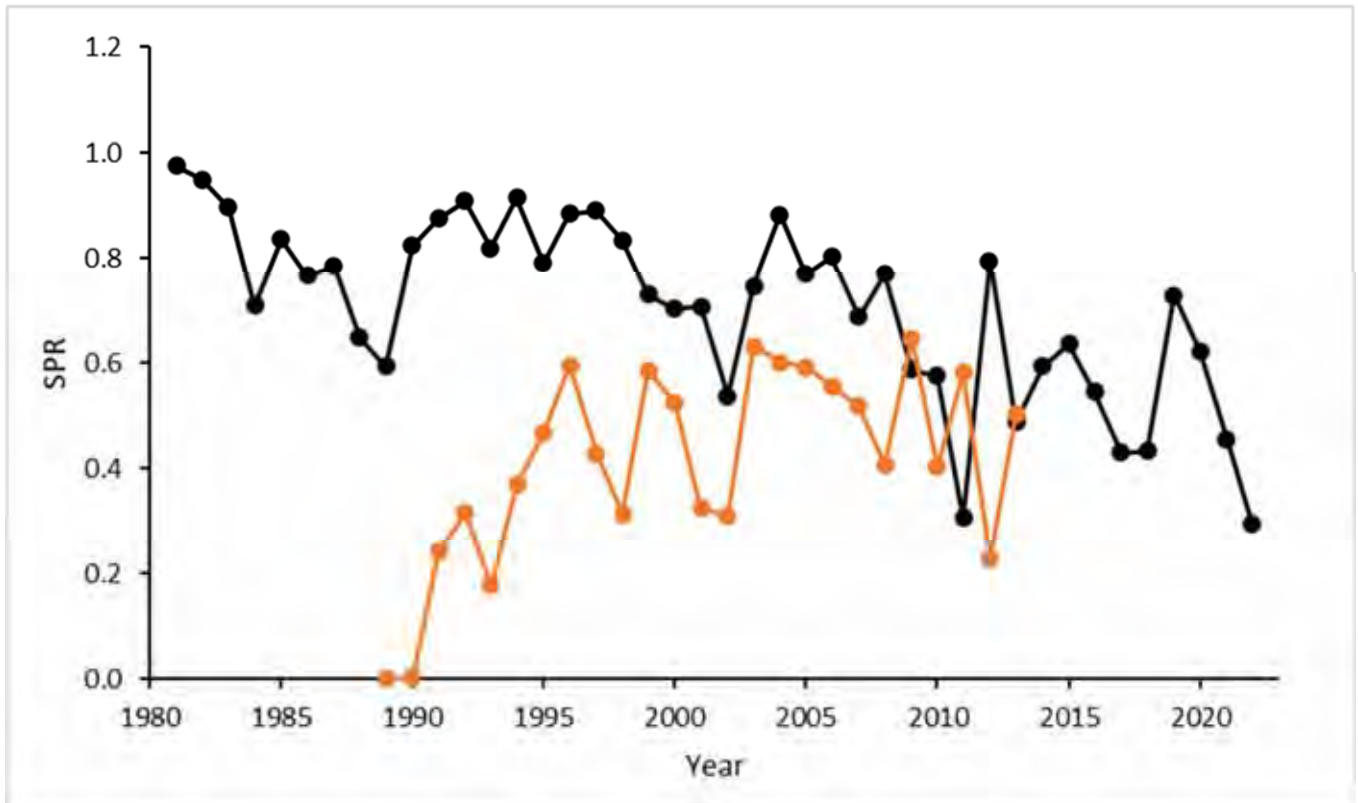


**Figure 154.** Total age-2 fishing mortality (F) for the northern stock SS estimated selectivity model (top) and hybrid selectivity model (bottom). Error bars are 95% confidence intervals based on asymptotic standard errors.

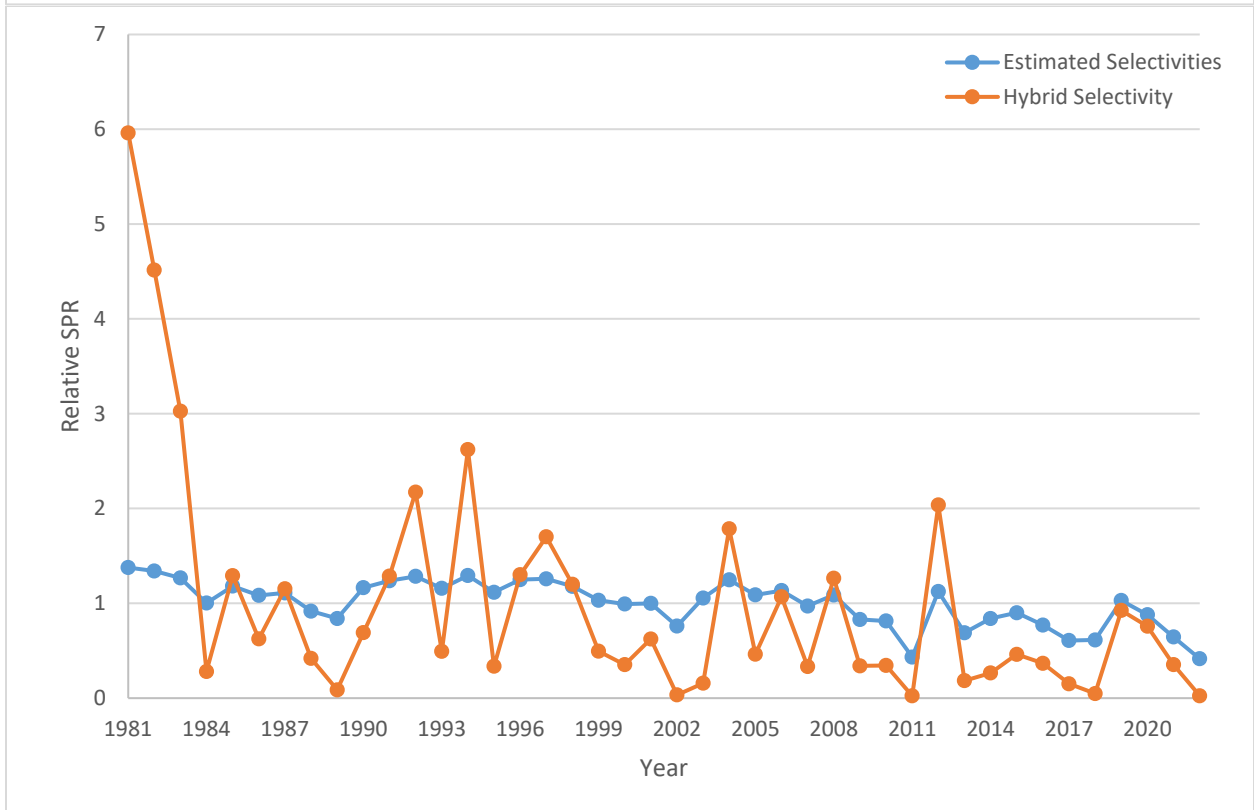
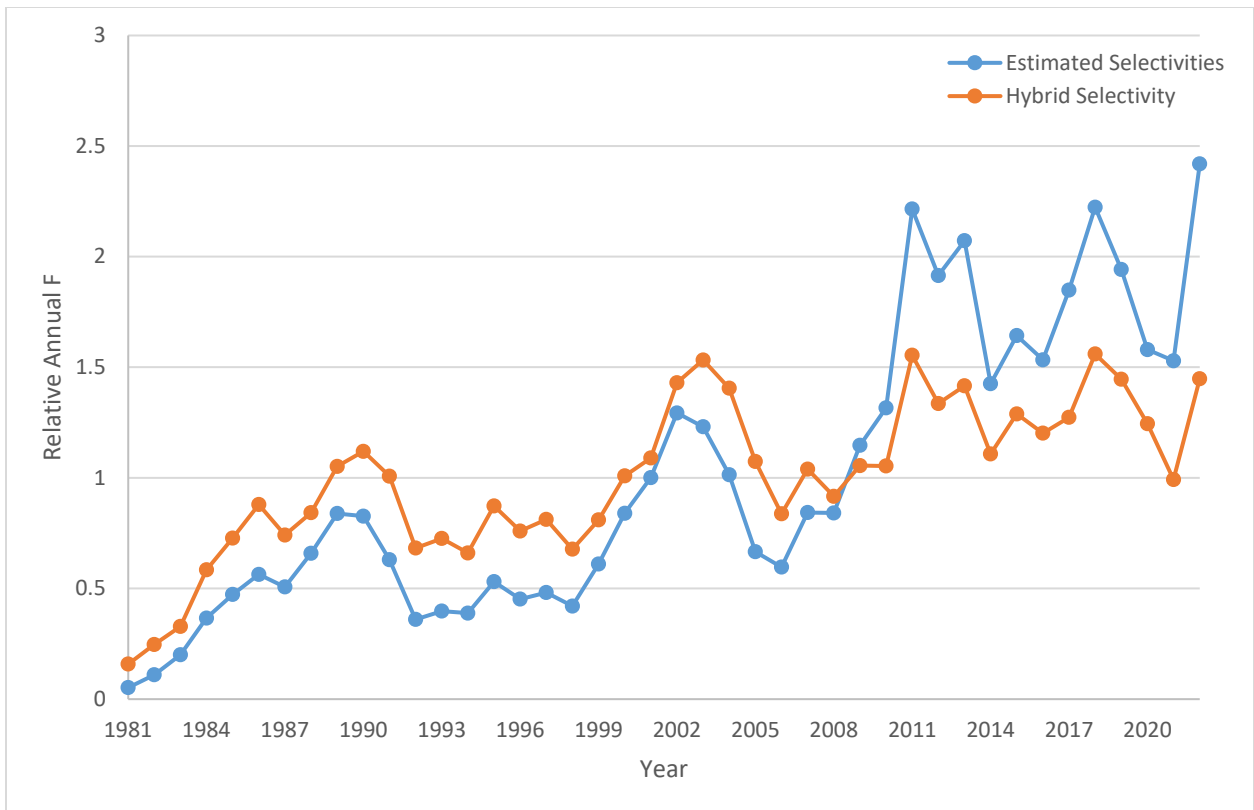




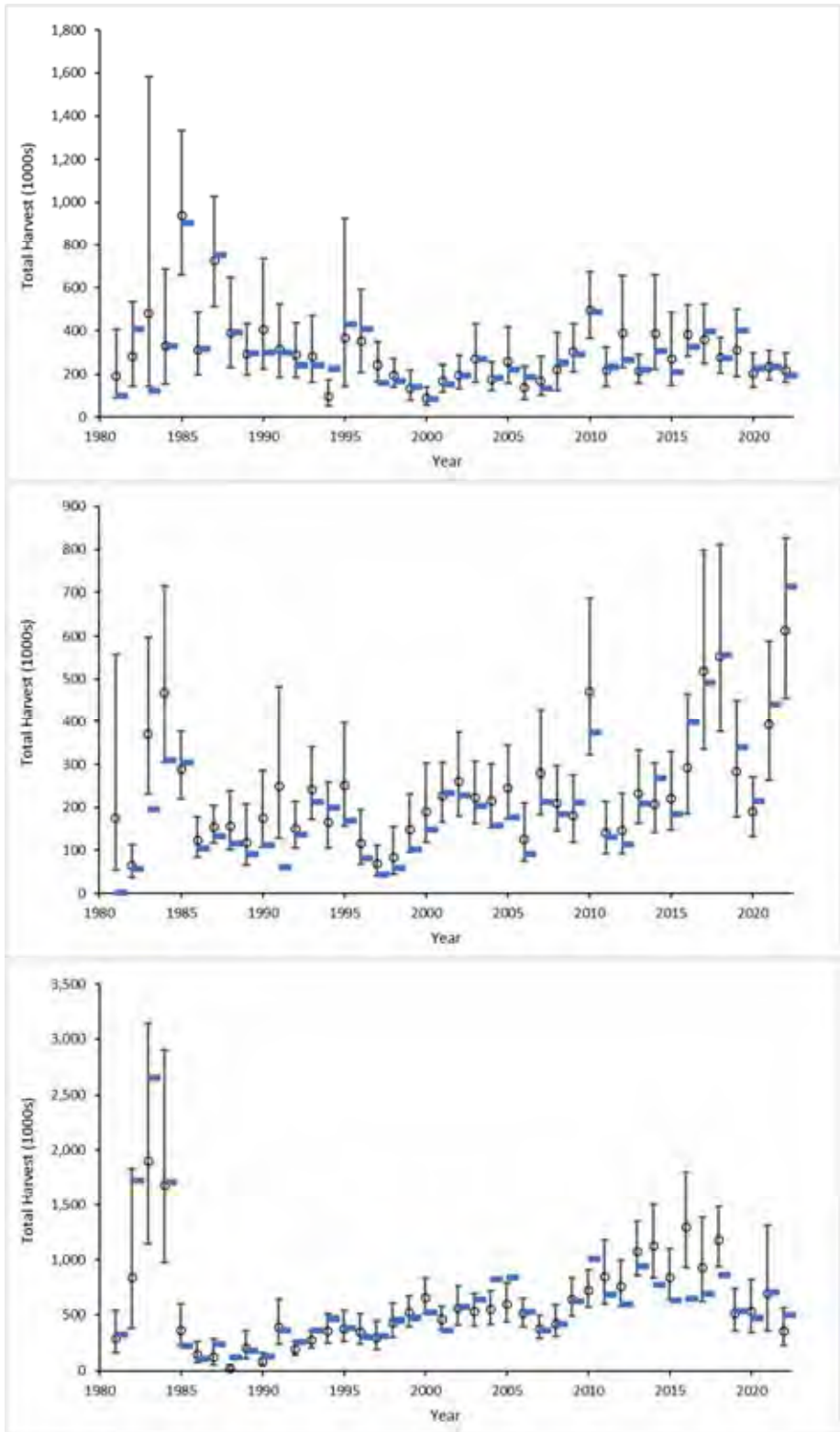
**Figure 155. SPR timeseries for the northern stock SS estimated selectivity model (top) and hybrid selectivity model (bottom). Horizontal line is the SPR target (0.30).**



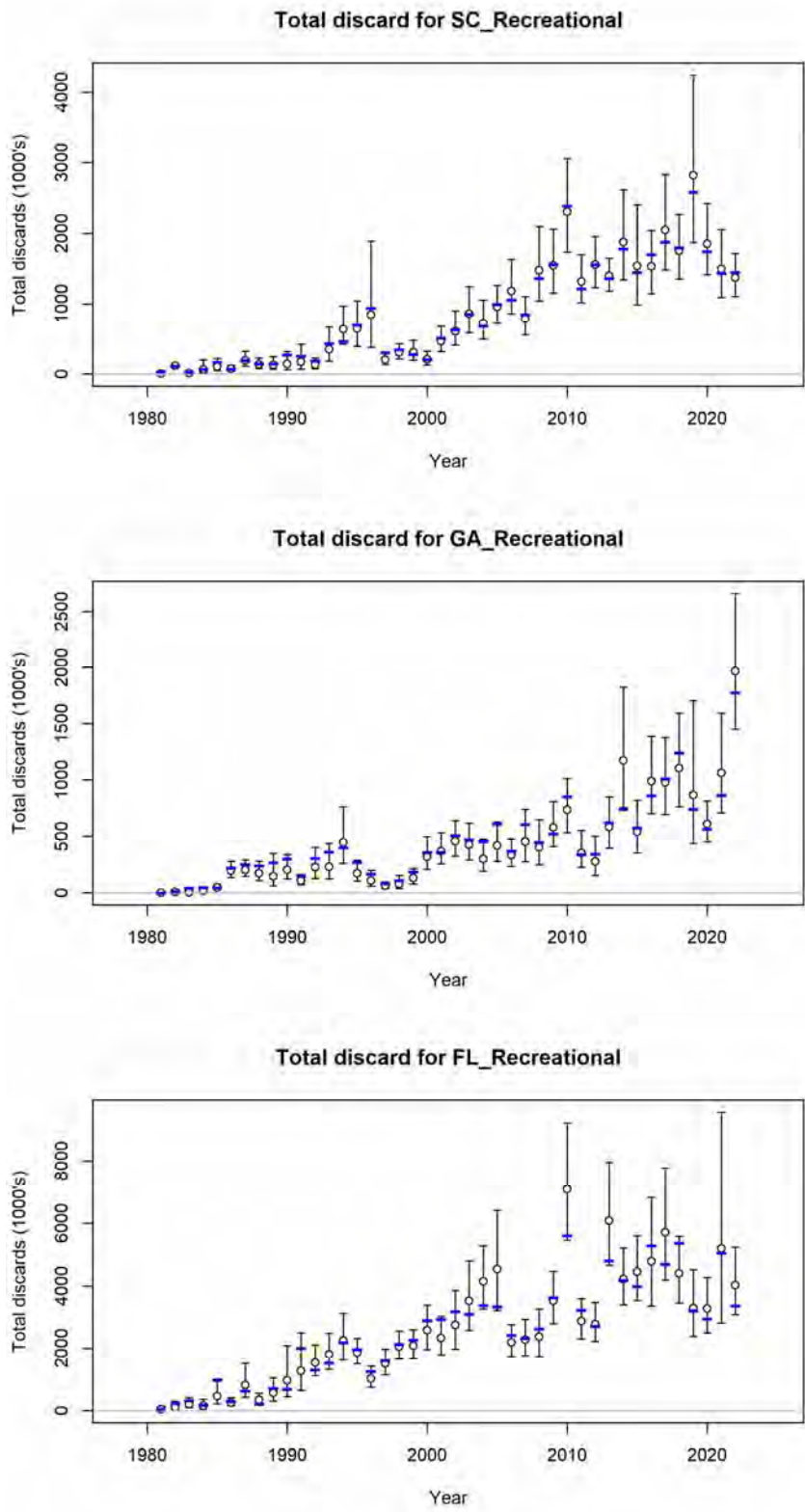
**Figure 156.** Spawning potential ratio estimates for the northern stock from the previous benchmark stock assessment using a custom statistical catch-at-age model (ASMFC 2017; orange) and the current benchmark assessment SS estimated selectivity model (black). Estimates from the previous assessment are for calendar years while estimates in the current assessment are for fishing years.



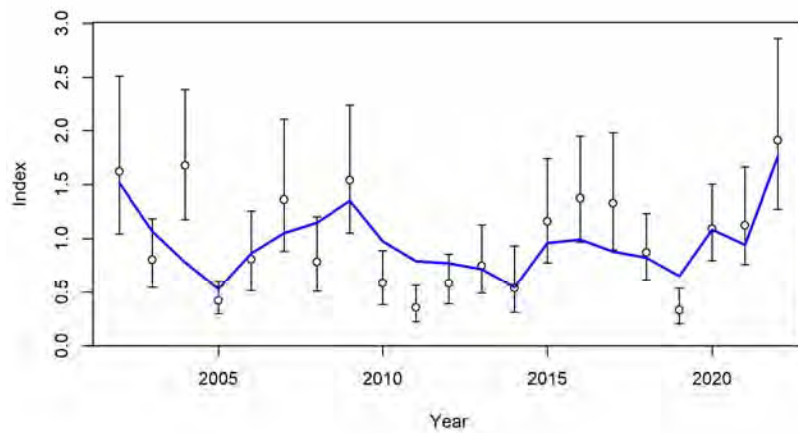
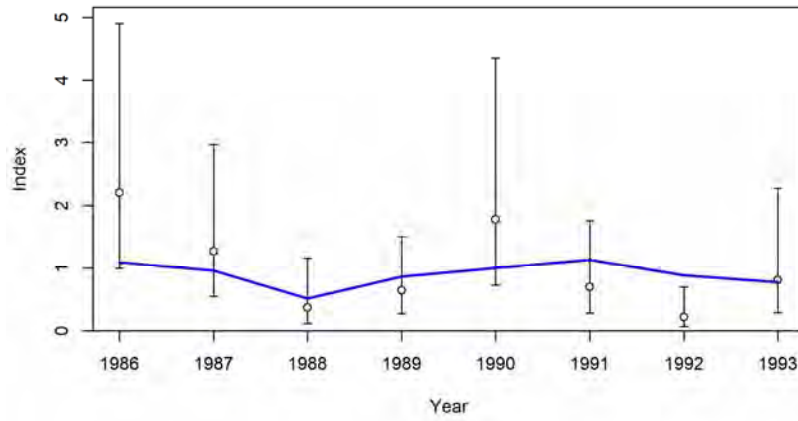
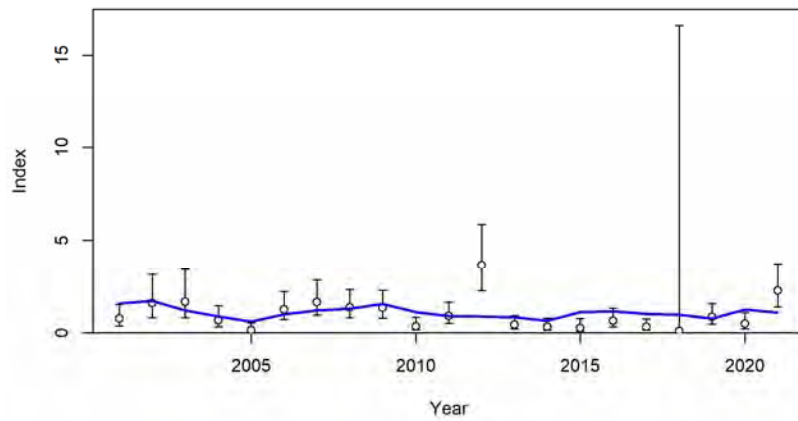
**Figure 157. F and SPR timeseries for the northern stock SS hybrid and estimated selectivity models, each scaled to their means.**



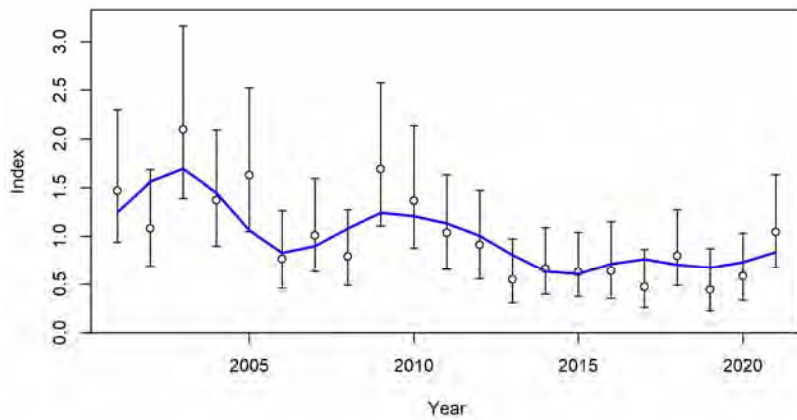
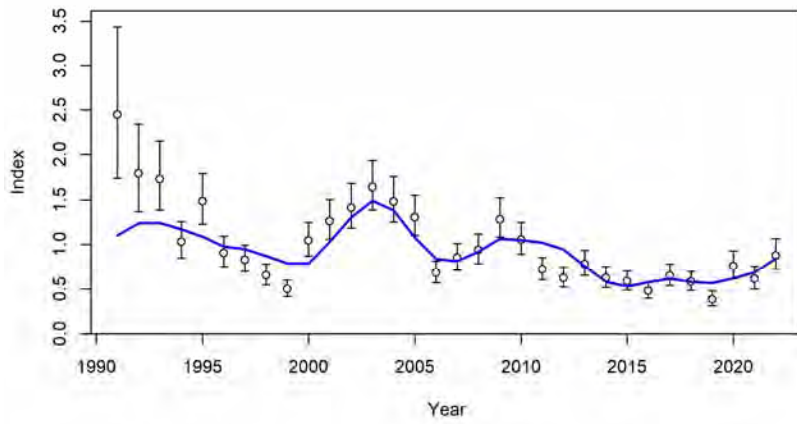
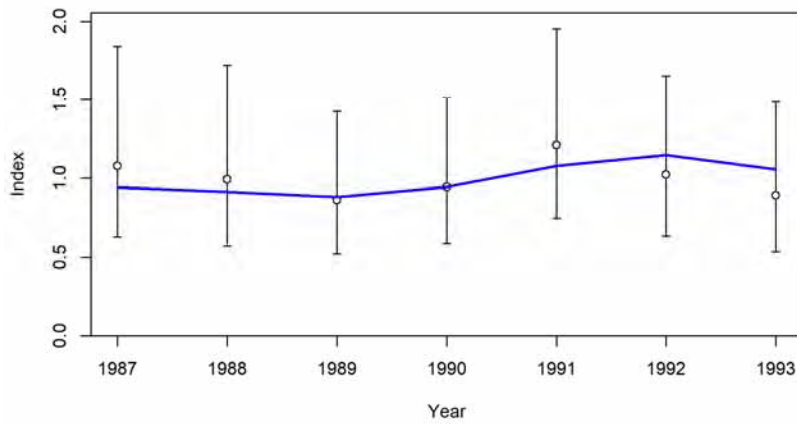
**Figure 158.** Observed and estimated catches for the SC\_Recreational (top), GA\_Recreational (middle), and FL\_Recreational (bottom) fleets for the southern stock SS base model.



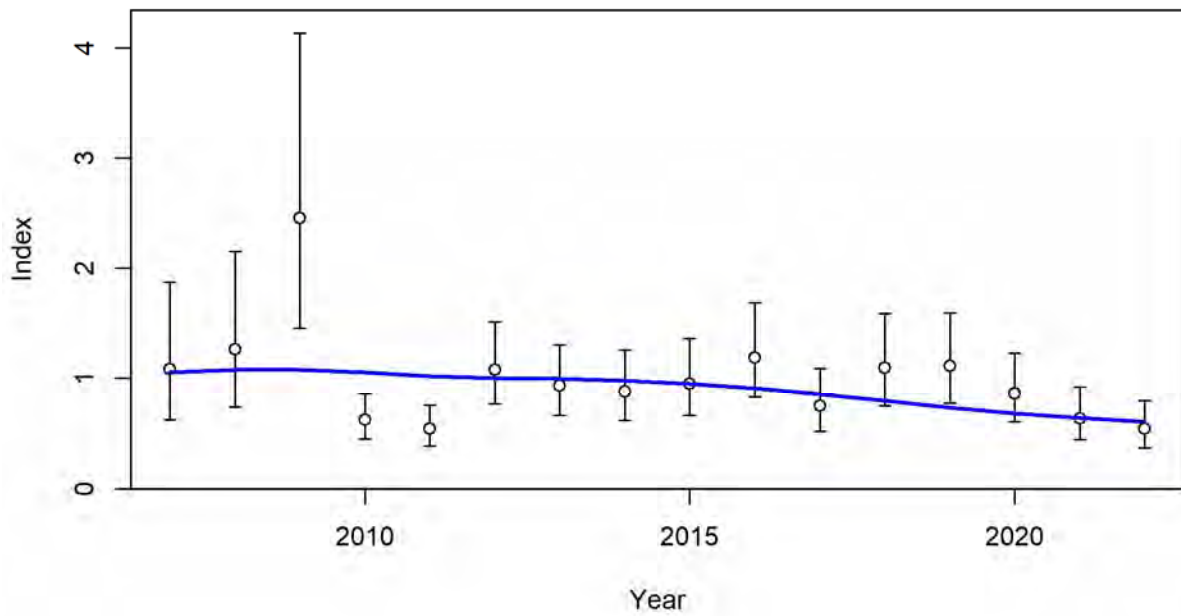
**Figure 159. Observed and estimated discards (in 1000's of fish) for the southern stock SS base model.**



**Figure 160.** Observed and estimated index values for the FL\_21.3\_HaulSeine (top), SC\_Rotenone (middle), and GA\_GillNet (bottom) age-0 recruitment surveys for the southern stock SS base model.

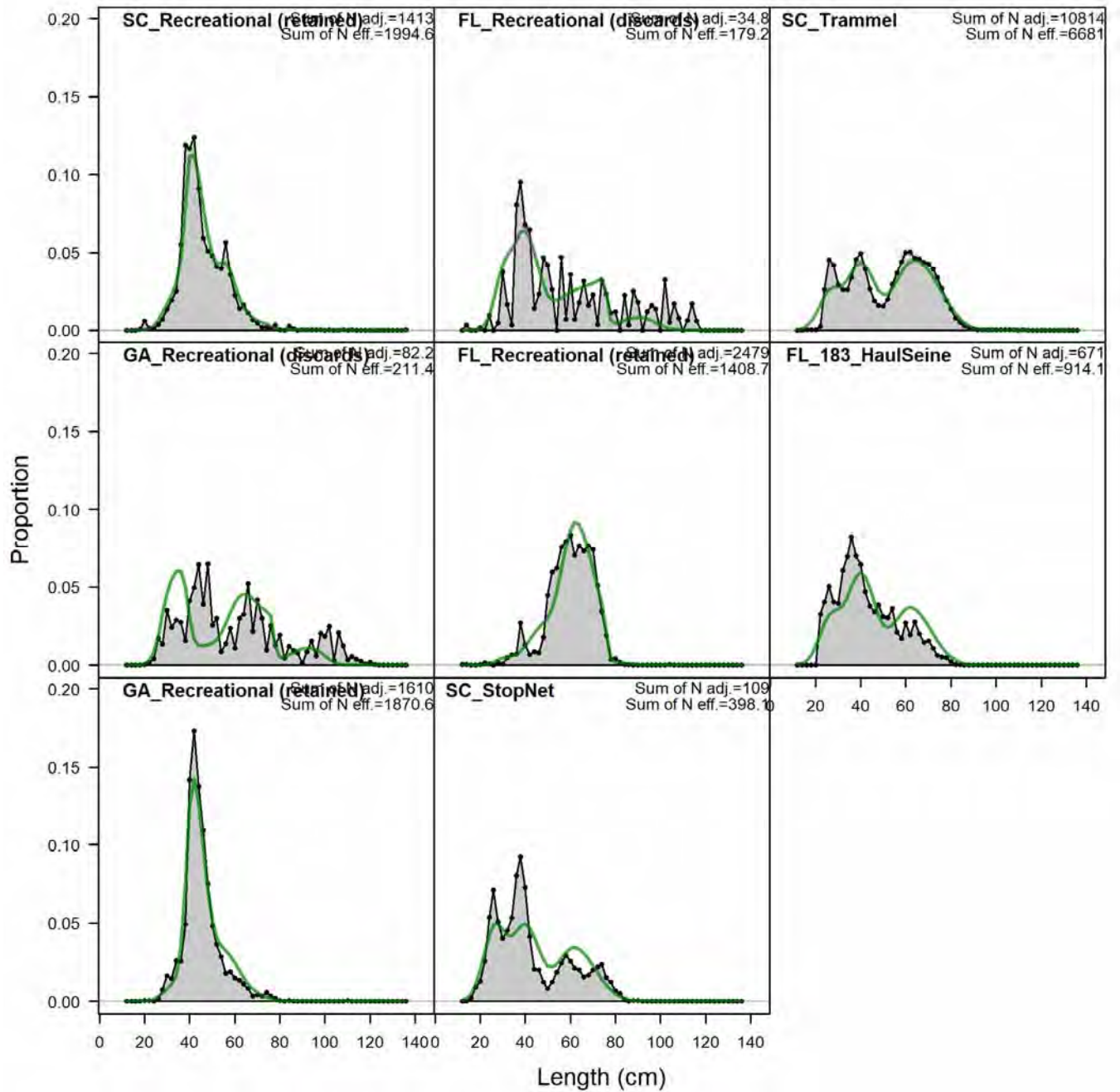


**Figure 161. Observed and estimated index values for the SC\_StopNet (top), SC\_Trammel (middle), and FL\_183\_HaulSeine (bottom) sub-adult surveys for the southern stock SS base model.**



**Figure 162. Observed and estimated index values for the adult longline survey for the southern stock SS base model.**





**Figure 163.** Length compositions, aggregated across time by fleet/survey for the southern stock SS base model.

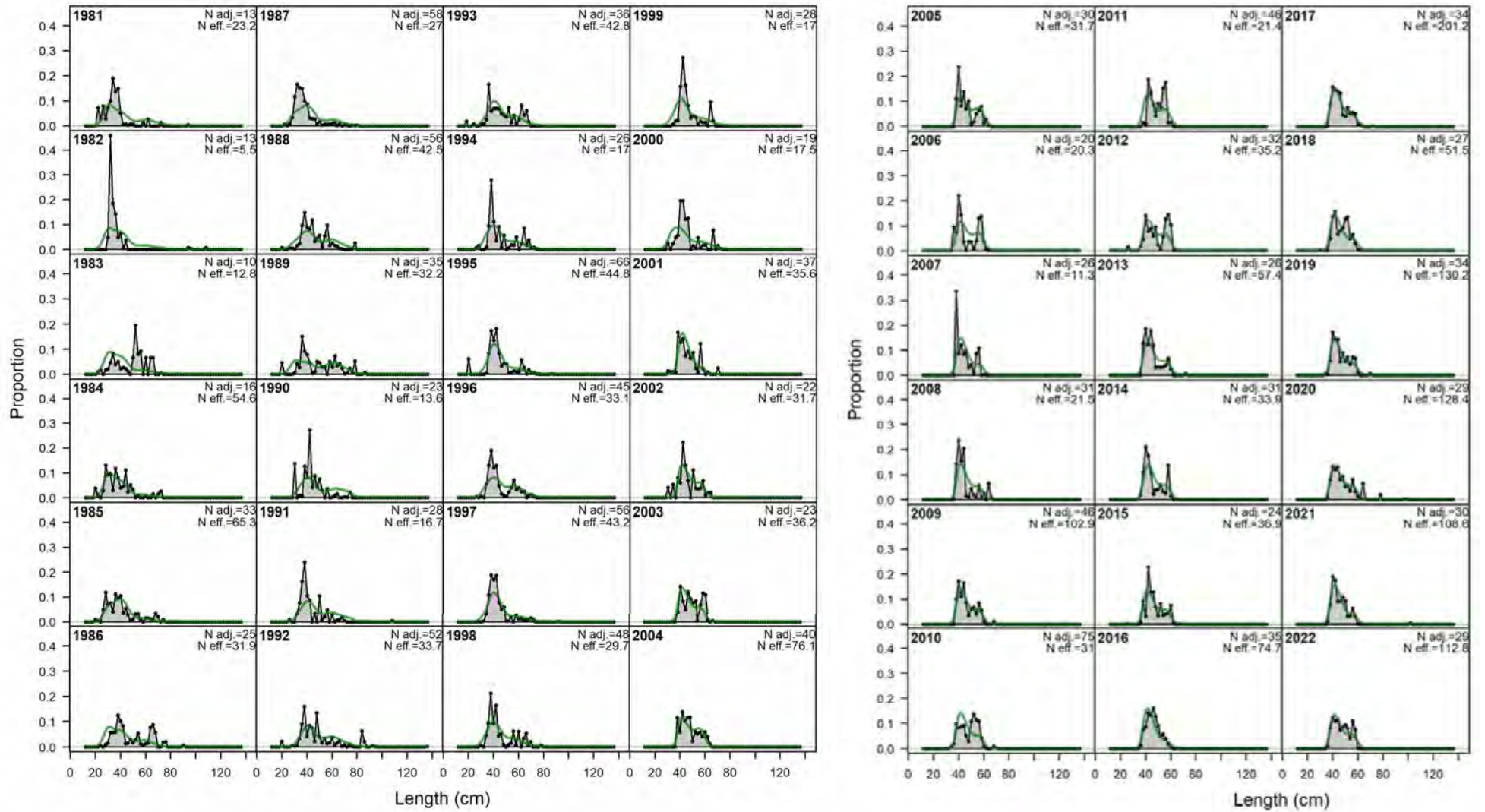
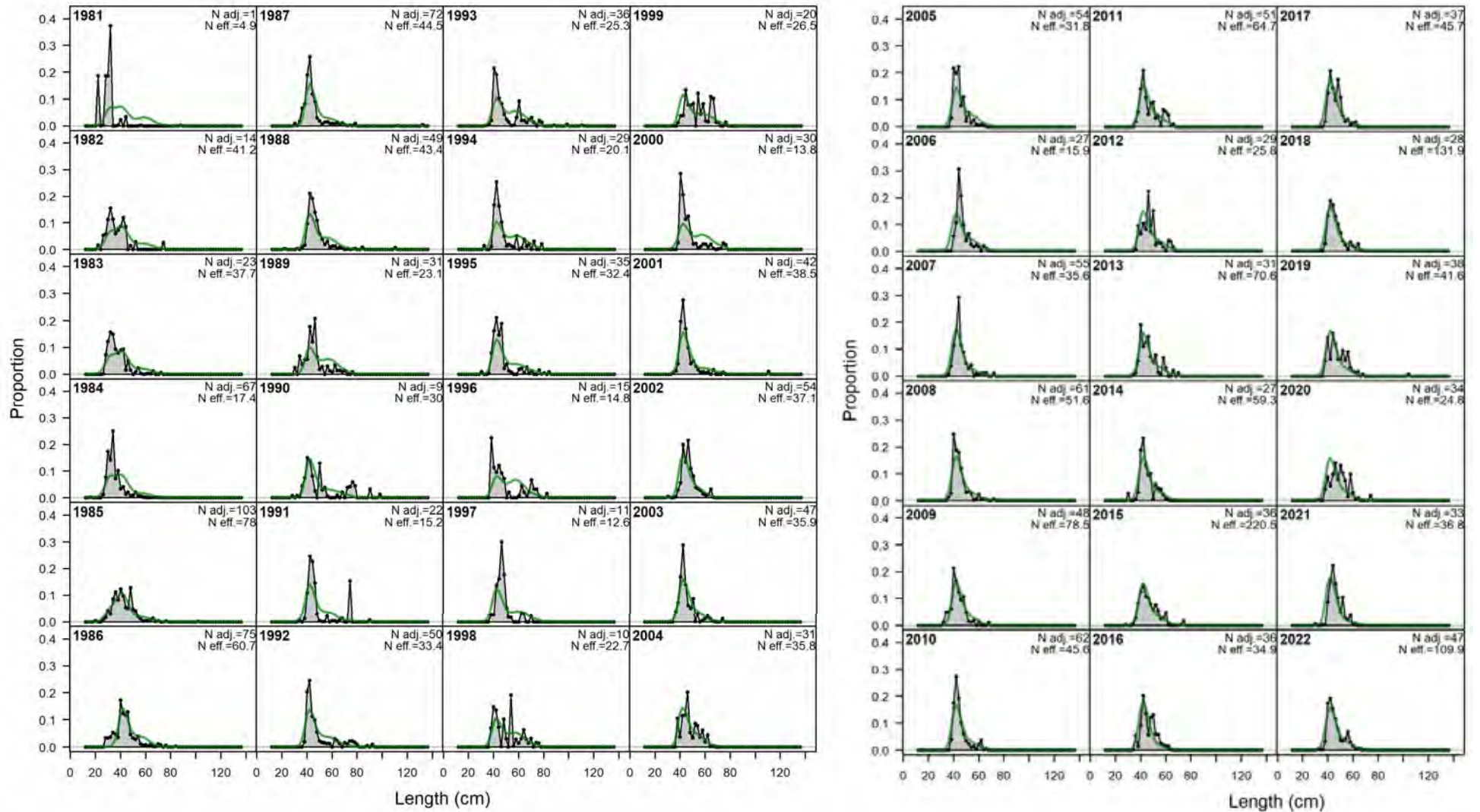
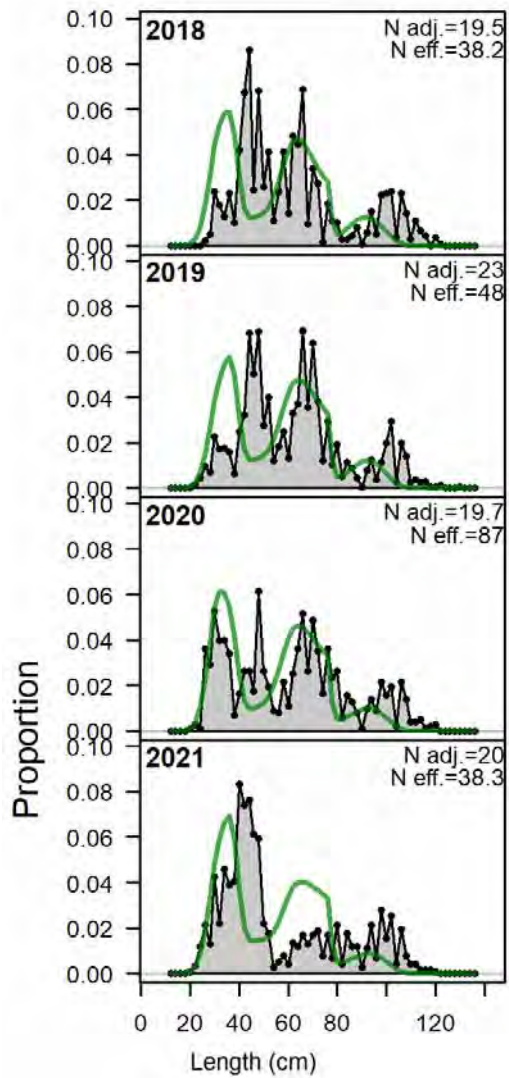


Figure 164. Annual length compositions for the SC\_Recreational fleet retained catch for the southern stock SS base model.



**Figure 165. Annual length compositions for the GA\_Recreational fleet retained catch for the southern stock SS base model.**





**Figure 166.** Annual length compositions for the GA\_Recreational fleet discards for the southern stock SS base model.

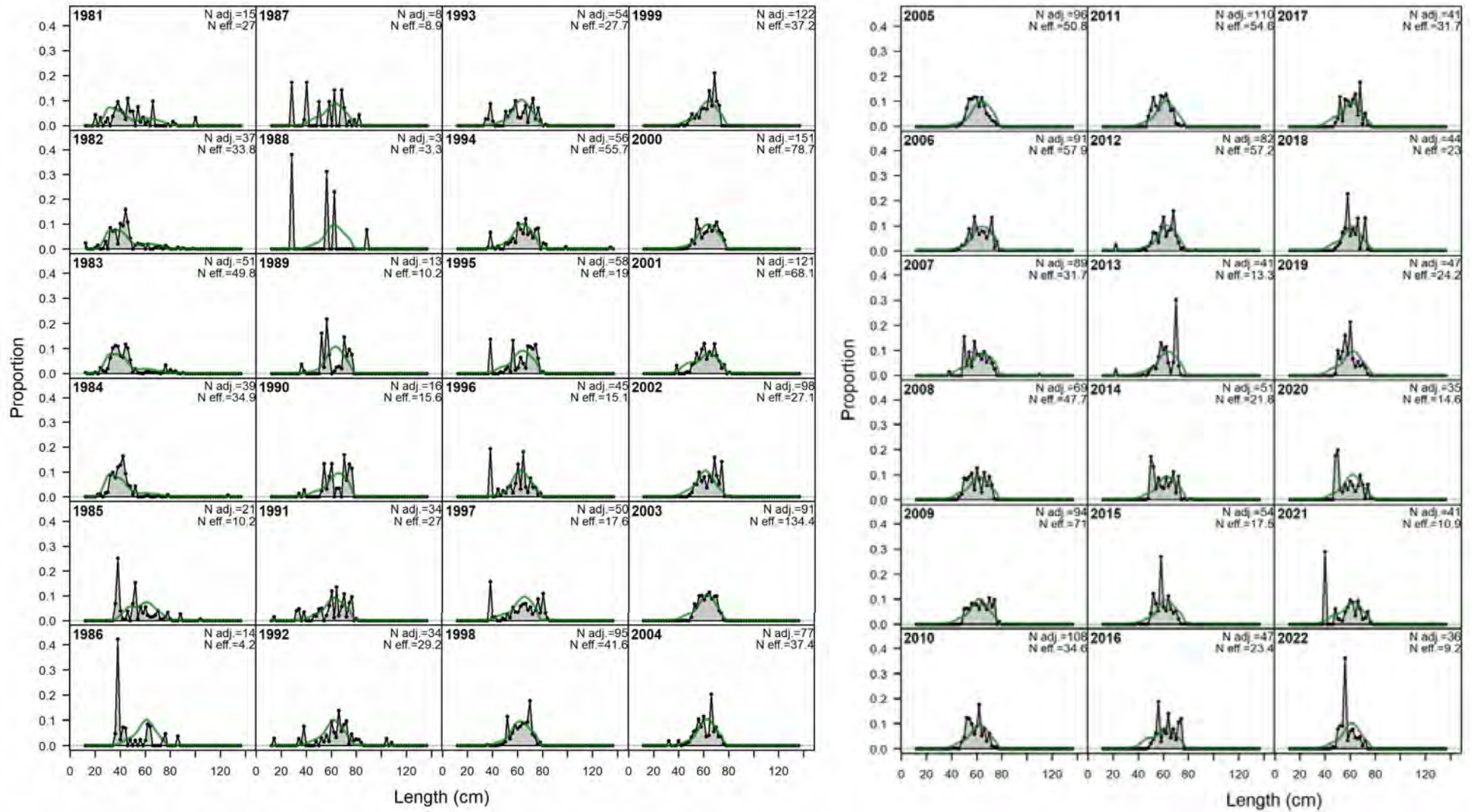
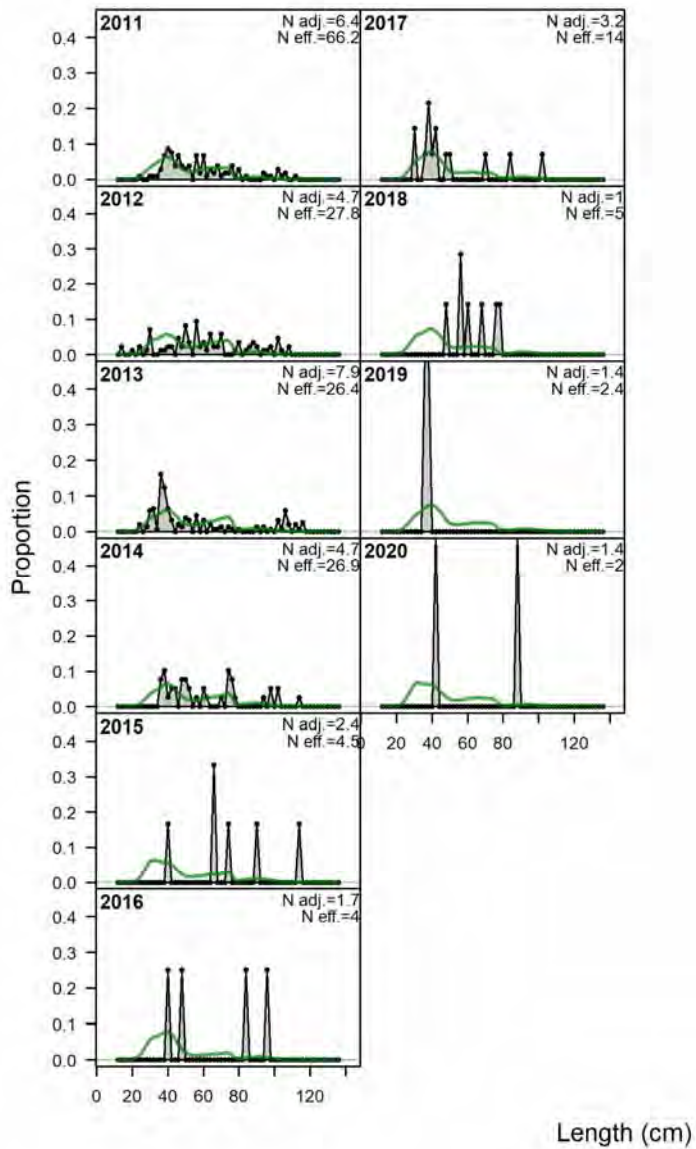
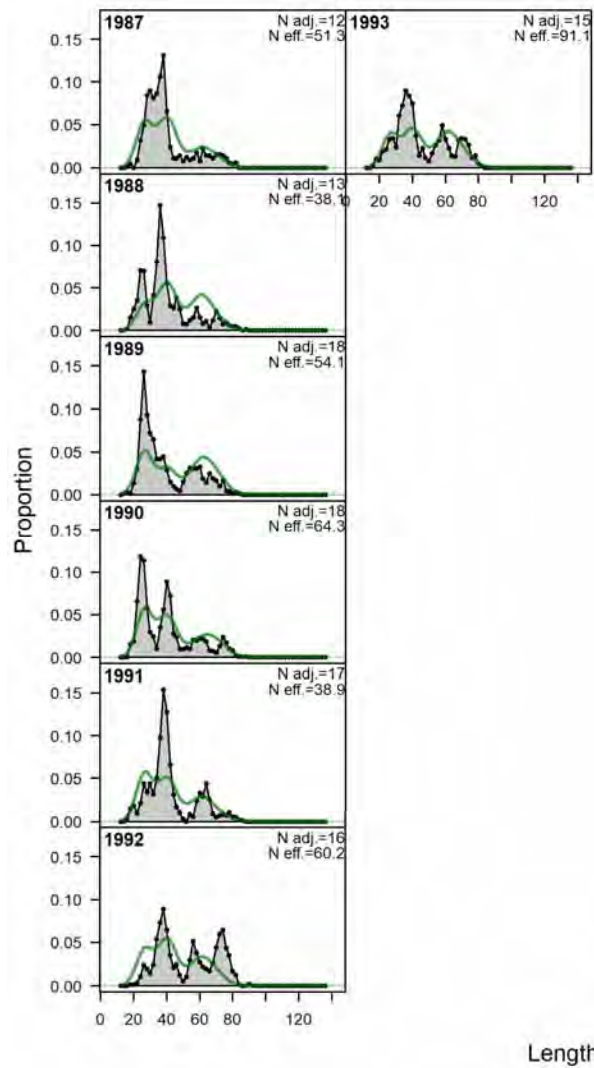


Figure 167. Annual length compositions for the FL\_Recreational fleet retained catch for the southern stock SS base model.



**Figure 168.** Annual length compositions for the FL\_Recreational fleet discards for the southern stock SS base model.



**Figure 169.** Annual length compositions for the SC\_StopNet survey for the southern stock SS base model.



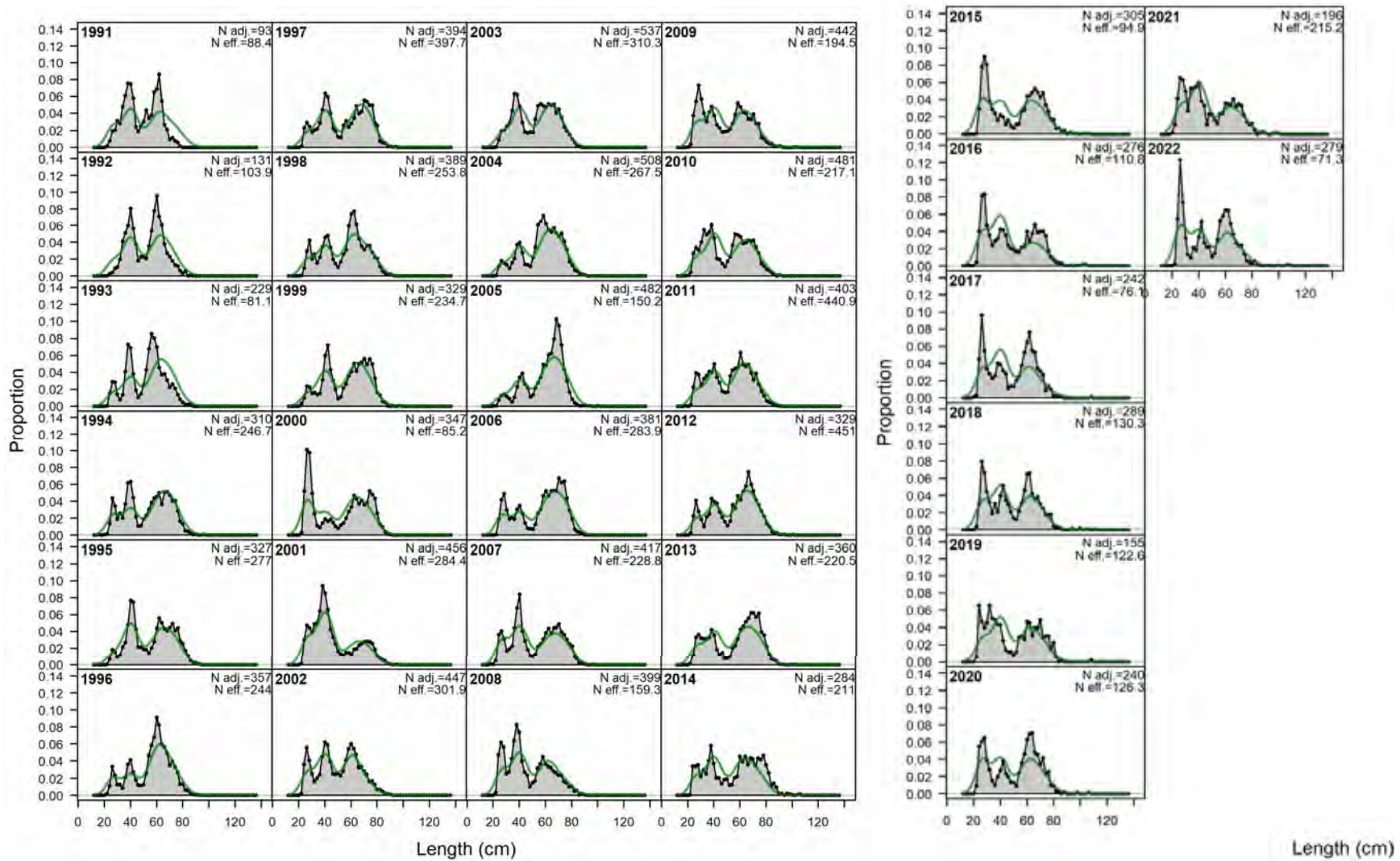
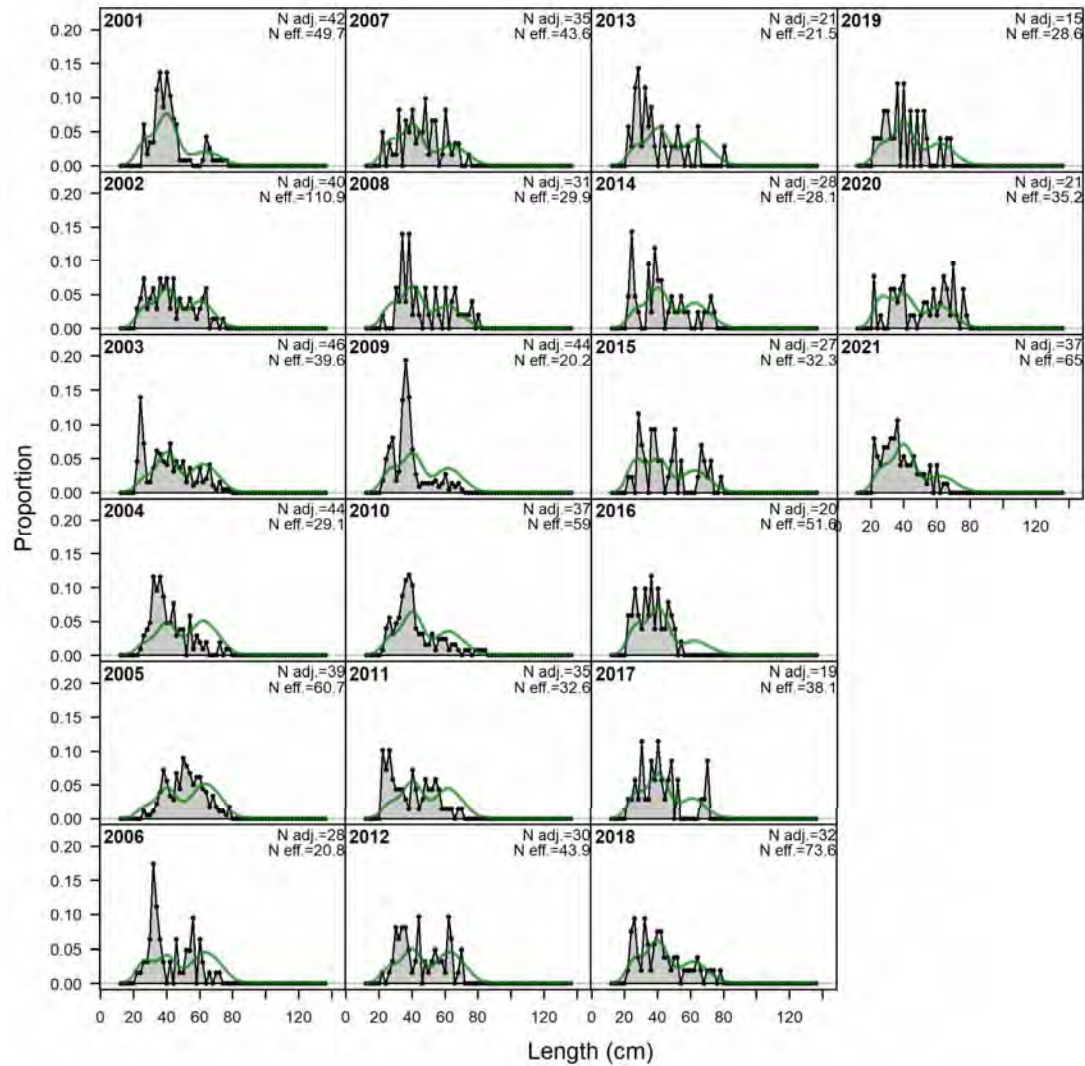
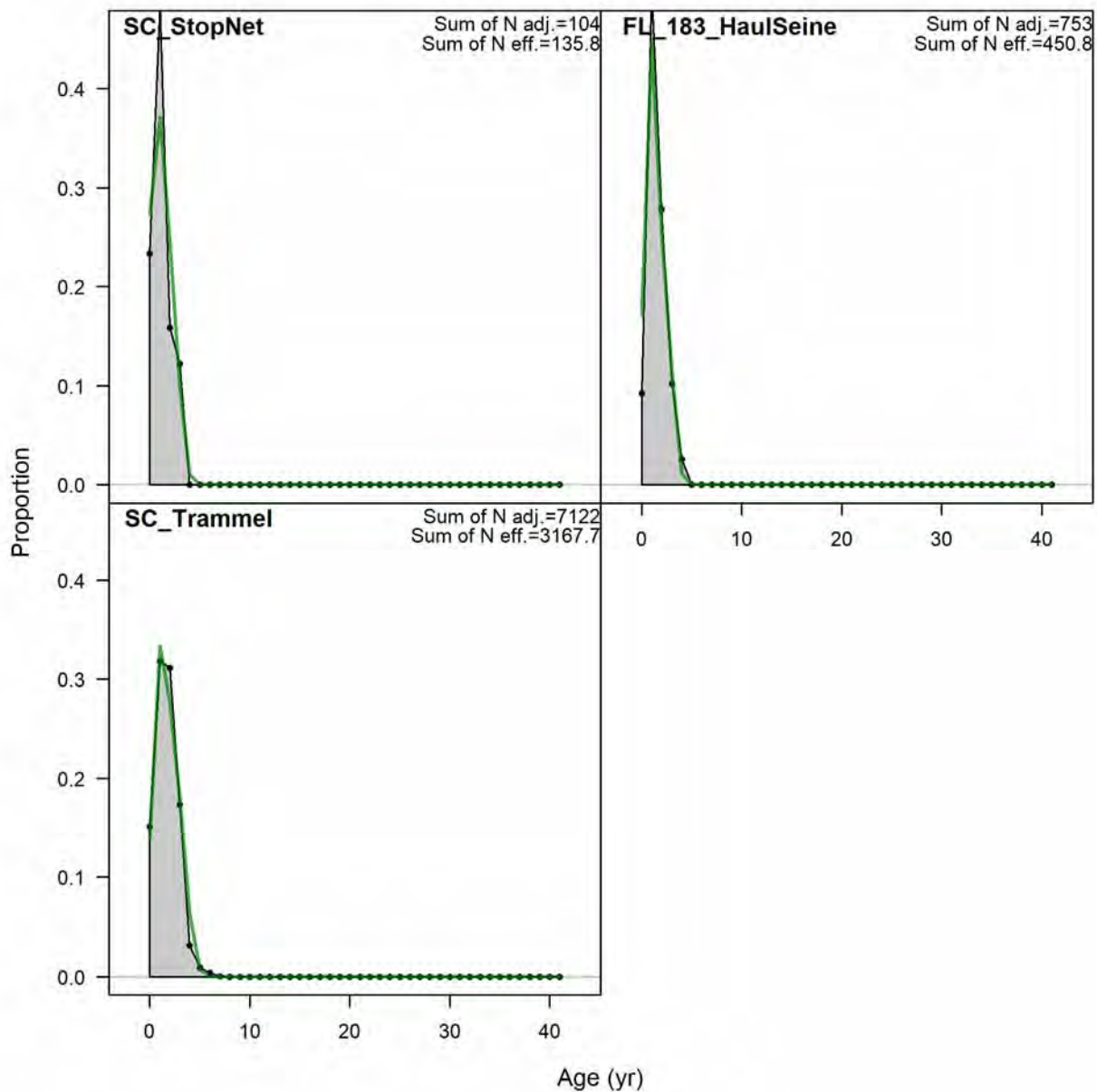


Figure 170. Annual length compositions for the SC\_Trammel survey for the southern stock SS base model.

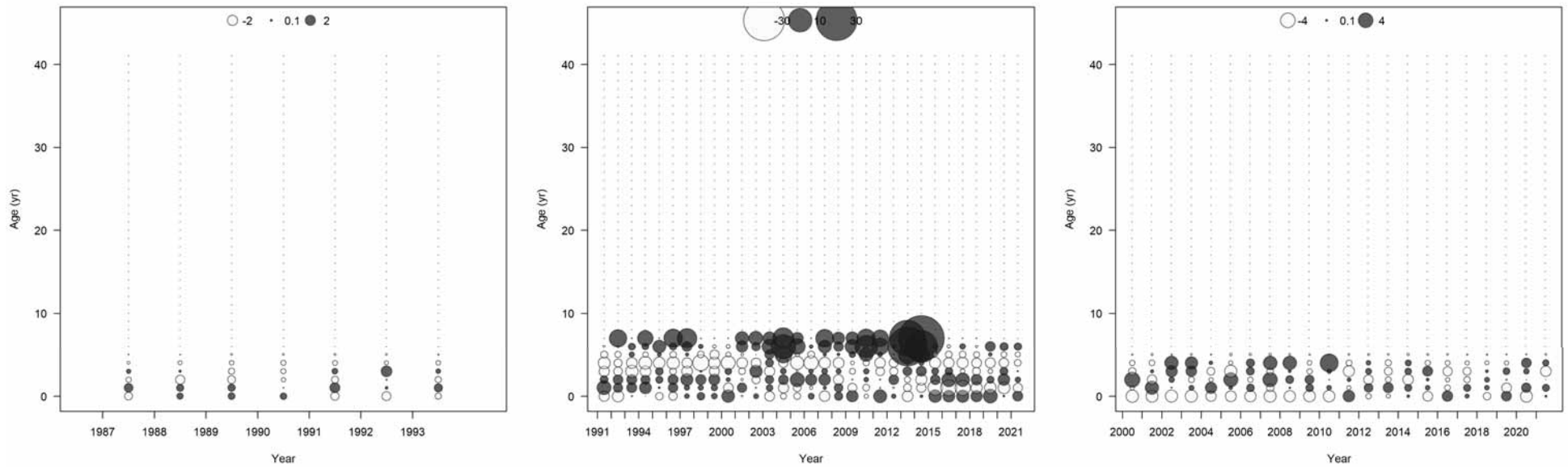




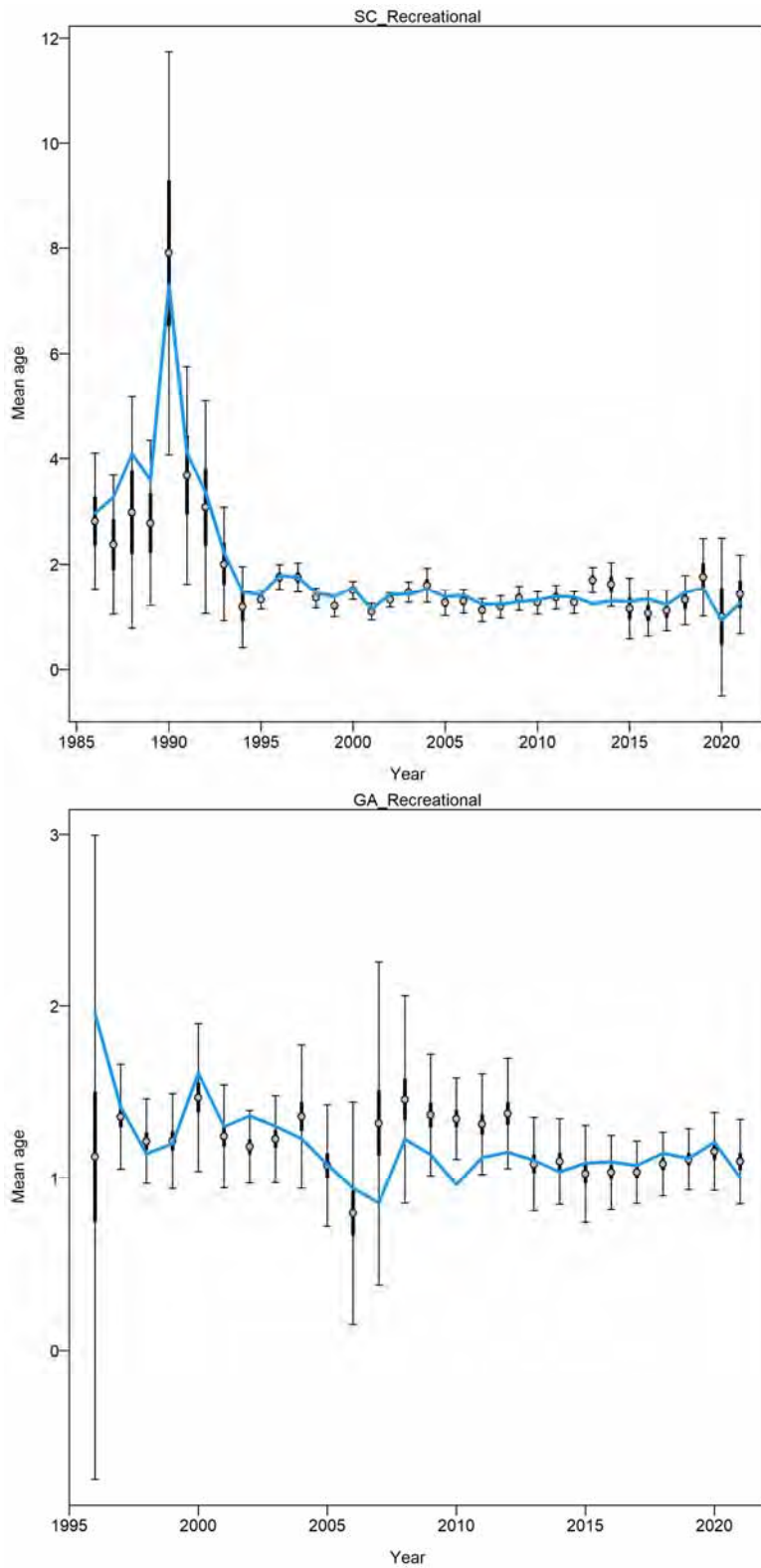
**Figure 171. Annual length compositions for the FL\_183\_HaulSeine survey for the southern stock SS base model.**



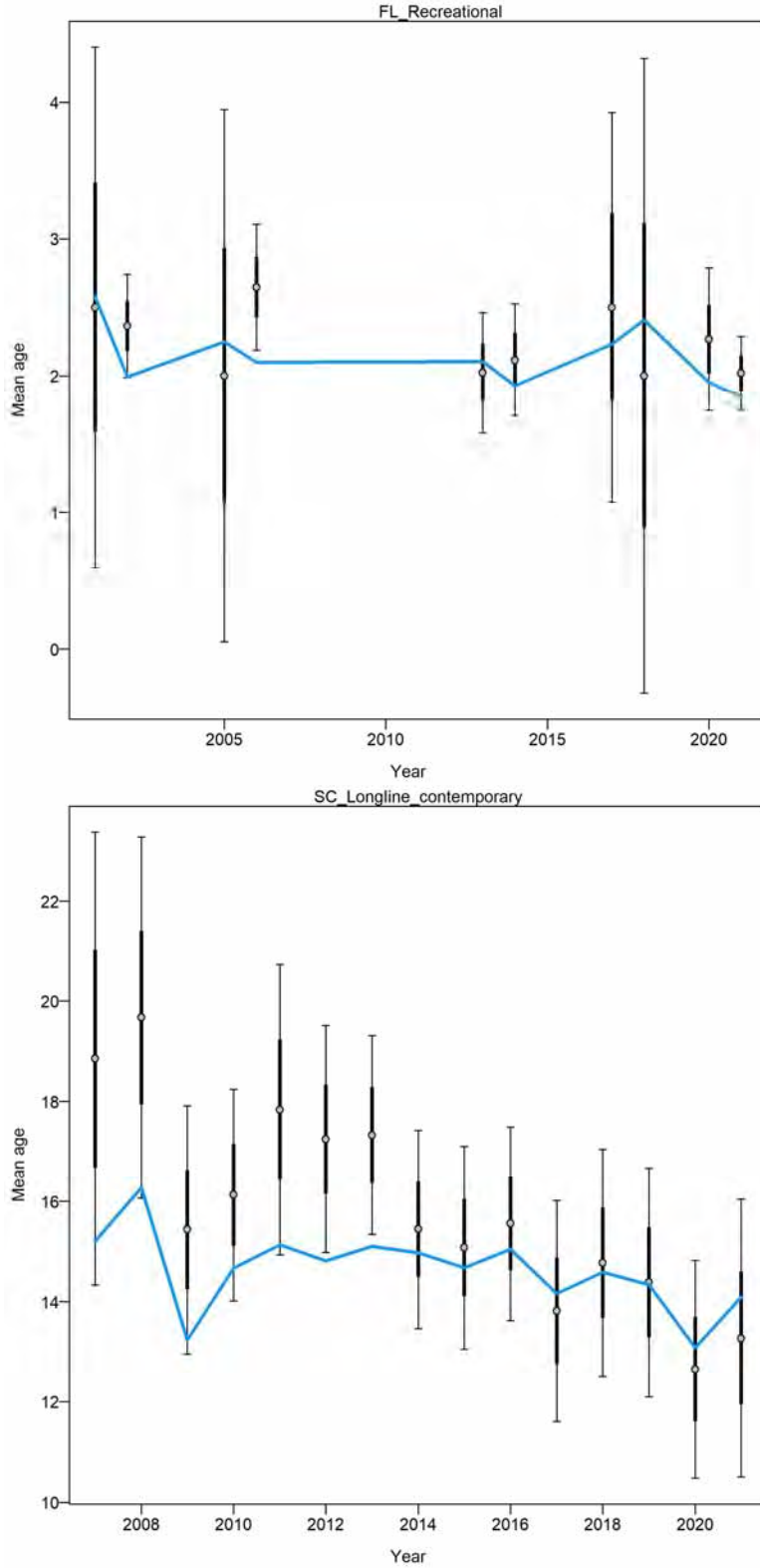
**Figure 172.** Age compositions, aggregated across time by survey for the southern stock SS base model.



**Figure 173. Annual age compositions for the SC\_StopNet (left), SC\_Trammel (middle), and FL\_183\_HaulSeine (right) surveys for the southern stock SS base model.**



**Figure 174.** Mean age from the conditional age data for the SC\_Recreational (top) and GA\_Recreational (bottom) fleets for the southern stock SS base model.



**Figure 175. Mean age from the conditional age data for the FL\_Recreational fleet (top) and SC\_Longline\_contemporary survey (bottom) for the southern stock SS base model.**

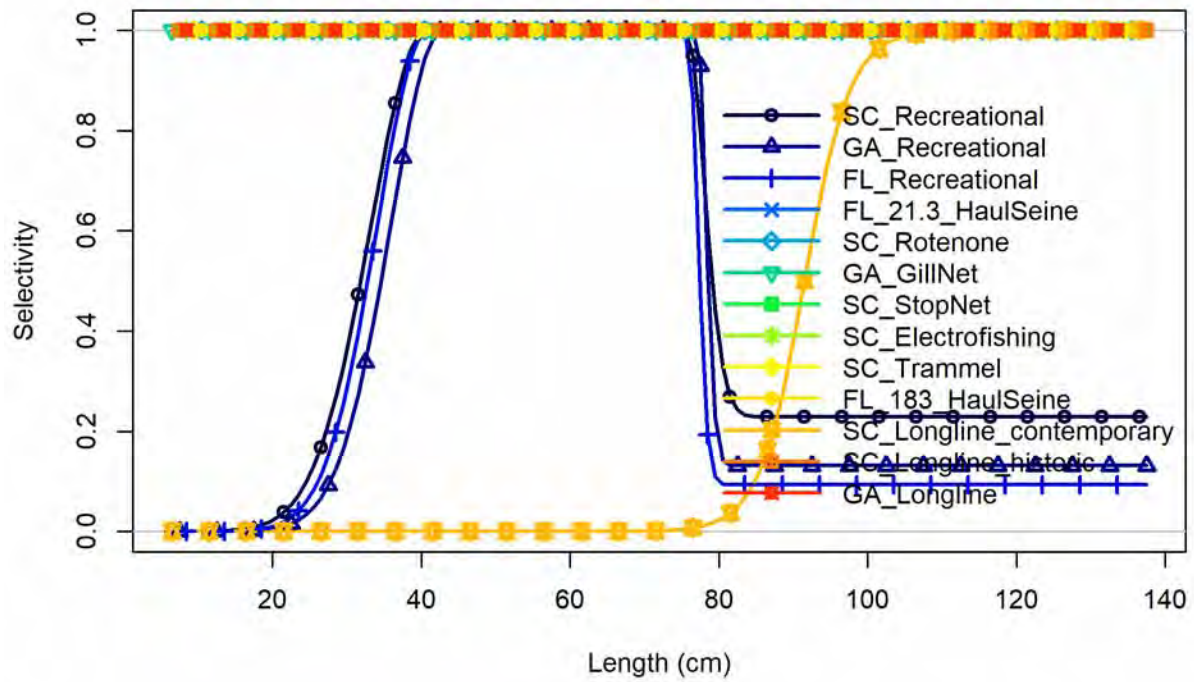
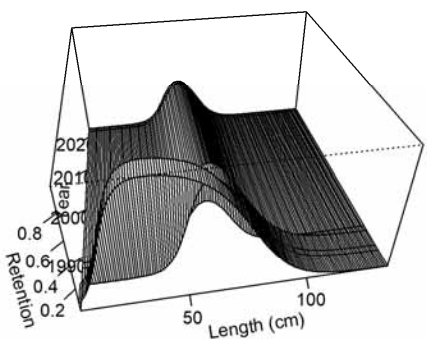
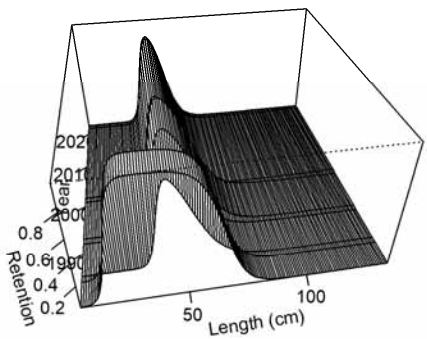
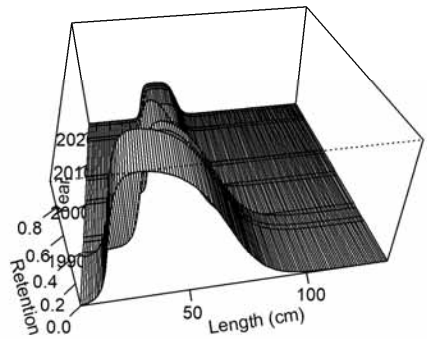
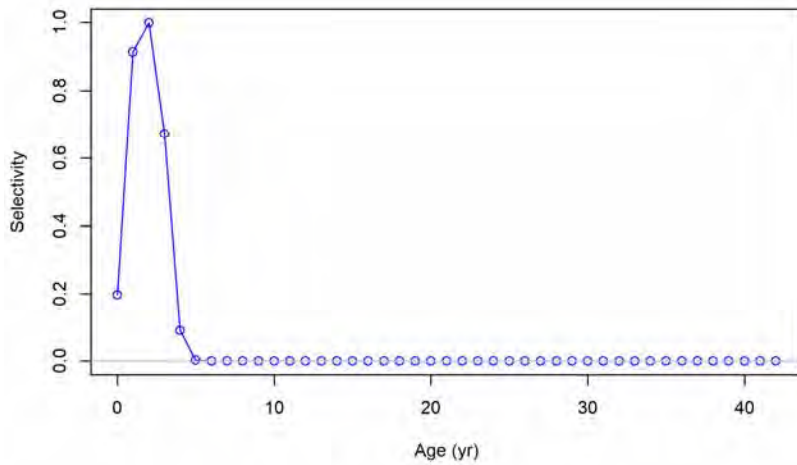
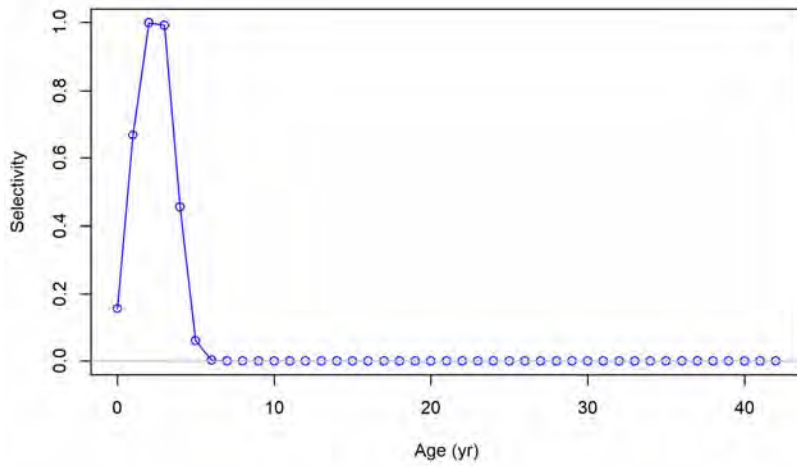
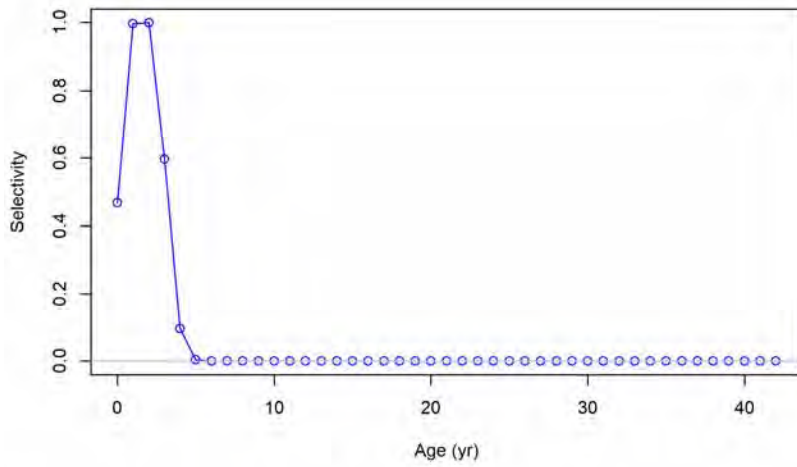


Figure 176. Length based selectivities for the southern stock SS base model. The SC\_Longline\_contemporary survey selectivity is fixed.

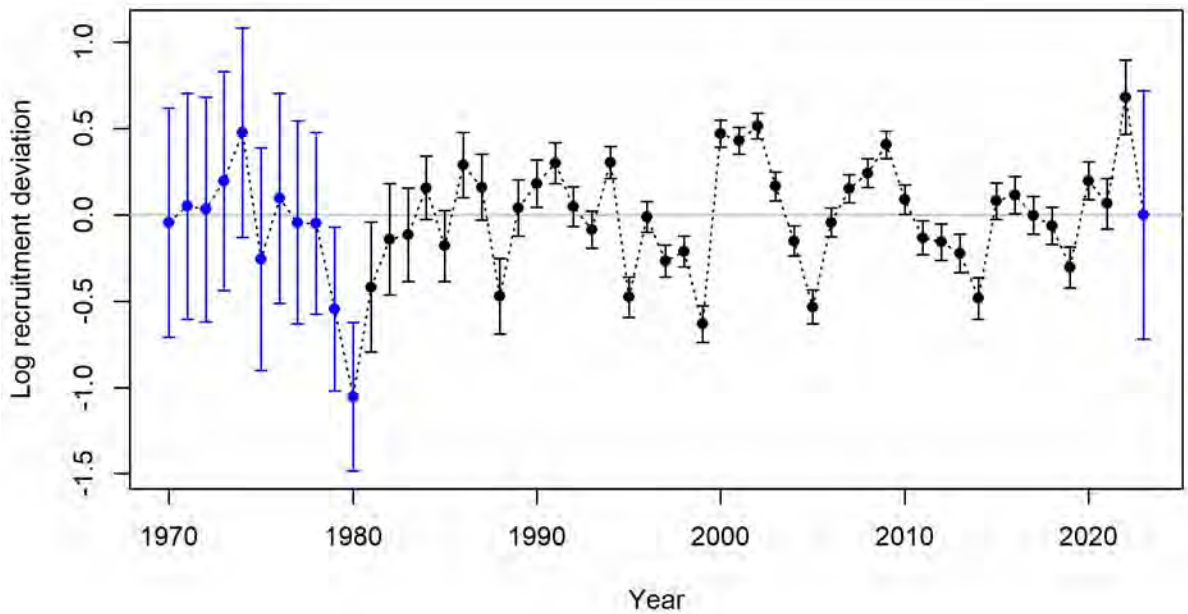


**Figure 177. Retention estimates, by regulatory period, for the SC\_Recreational (top), GA\_Recreational (middle), and FL\_Recreational (bottom) fleets for the southern stock SS base model.**

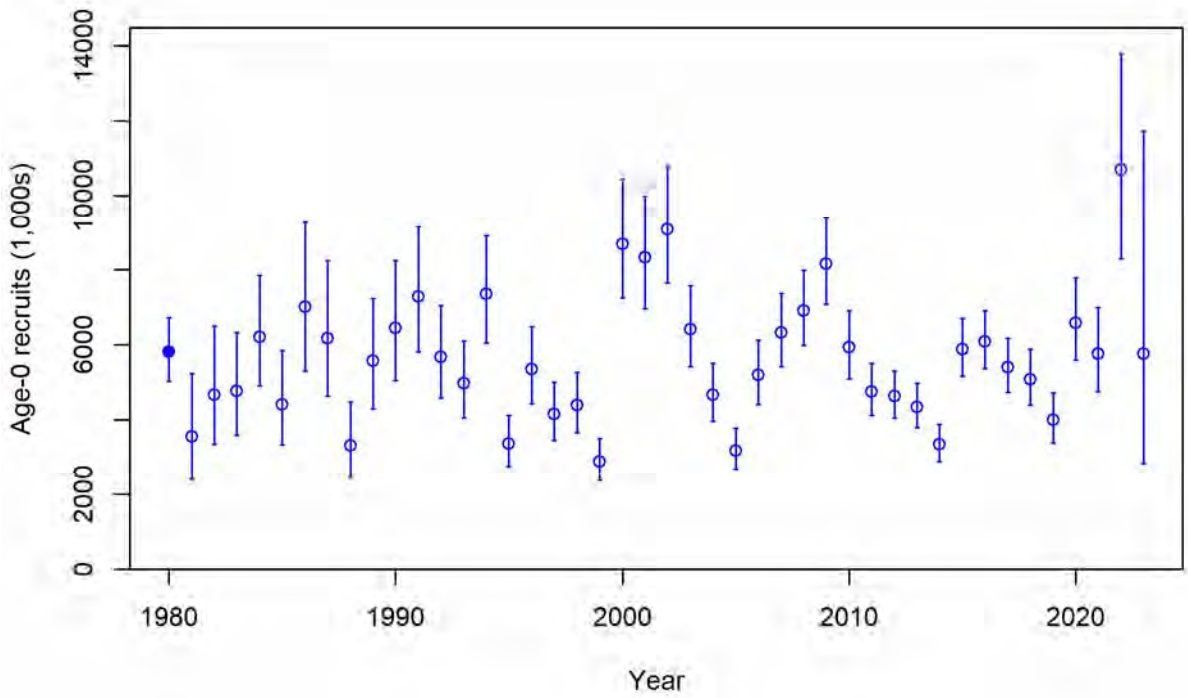


**Figure 178. Age based selectivities estimated for the SC\_StopNet (top), SC\_Trammel (middle), and FL\_183\_HaulSeine (bottom) surveys for the southern stock SS base model.**

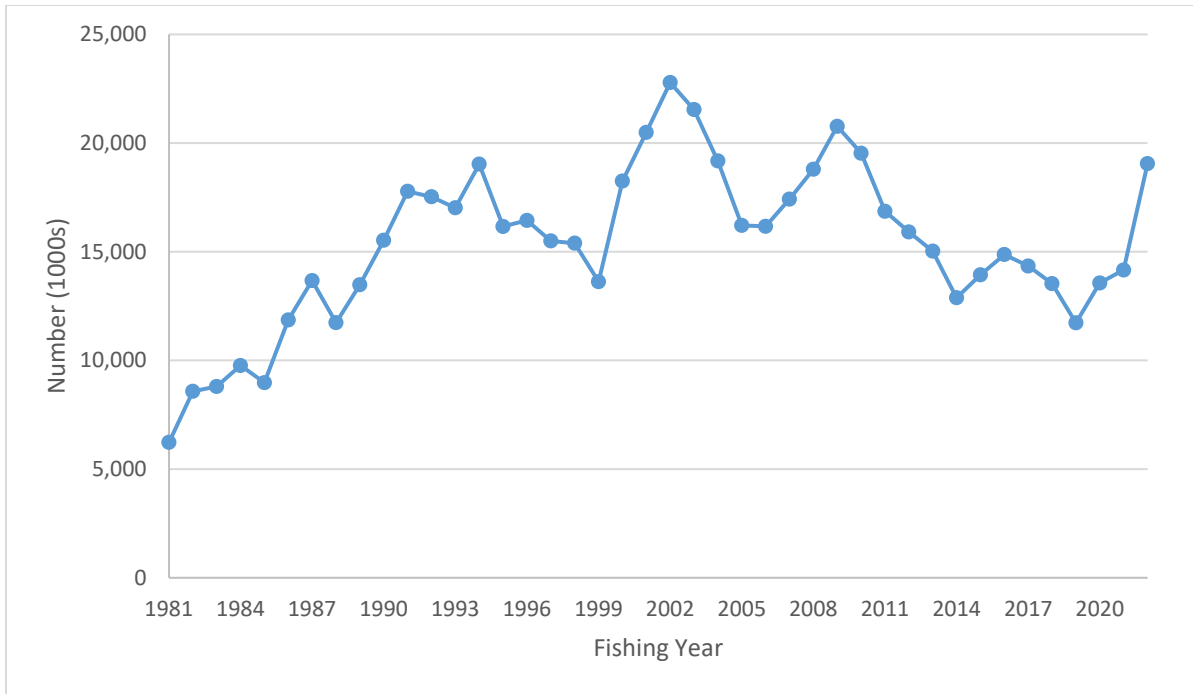




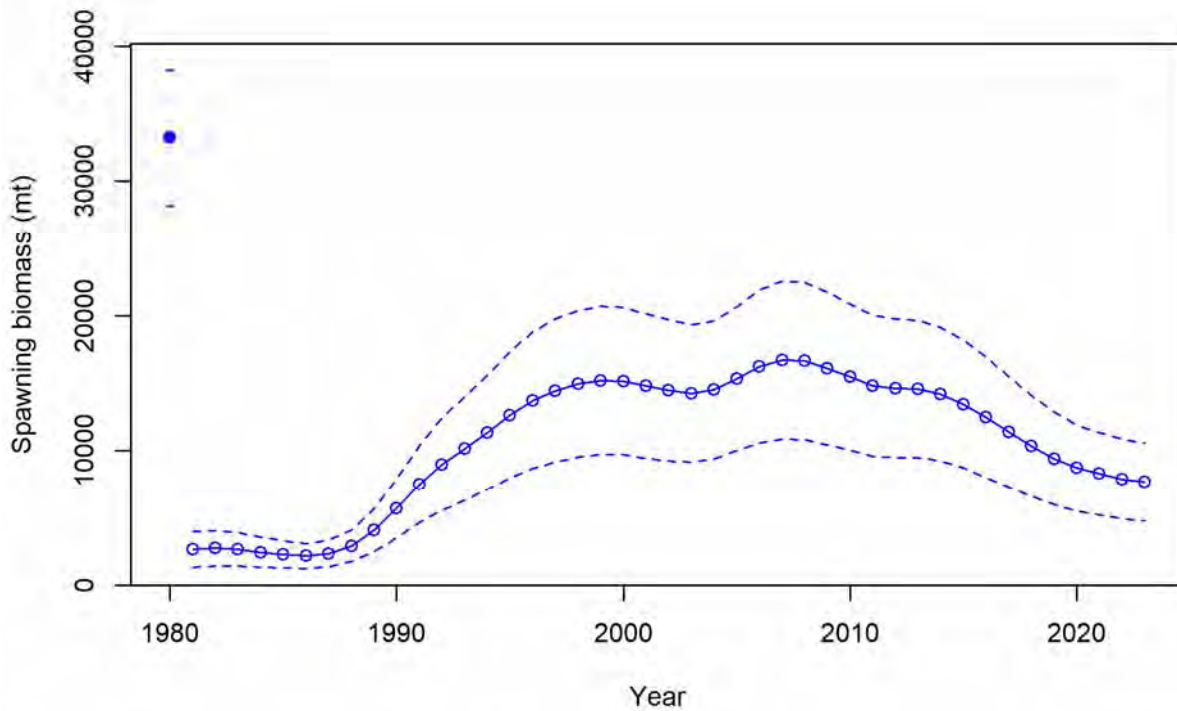
**Figure 179.** Recruitment deviations, with 95% confidence intervals from asymptotic standard errors, for the southern stock SS base model.



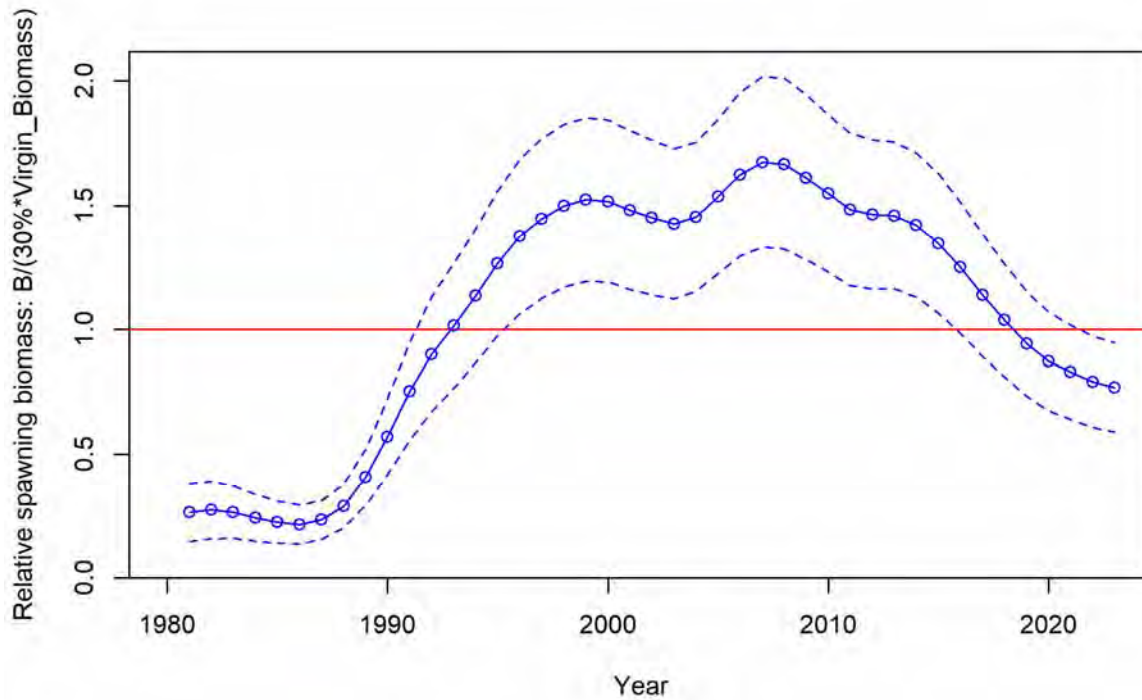
**Figure 180.** Estimated recruitment (in 1000s) for the southern stock SS base model. Error bars are 95% confidence intervals based on asymptotic standard errors.



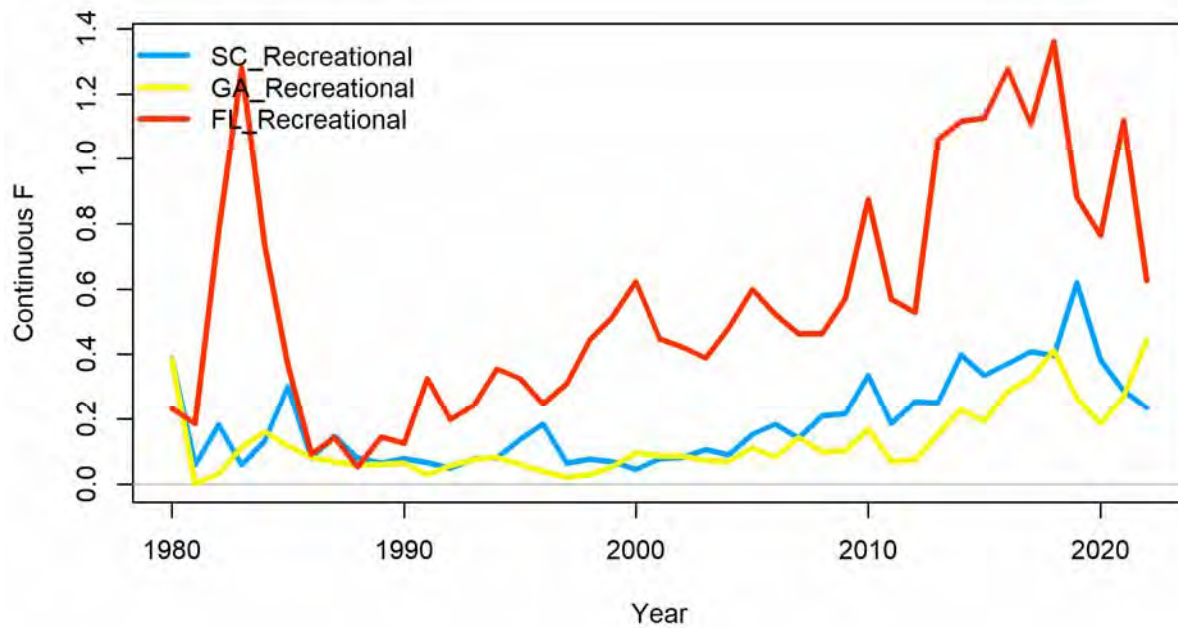
**Figure 181. Estimated population abundance (in 1000s of fish) for the southern stock SS base model.**



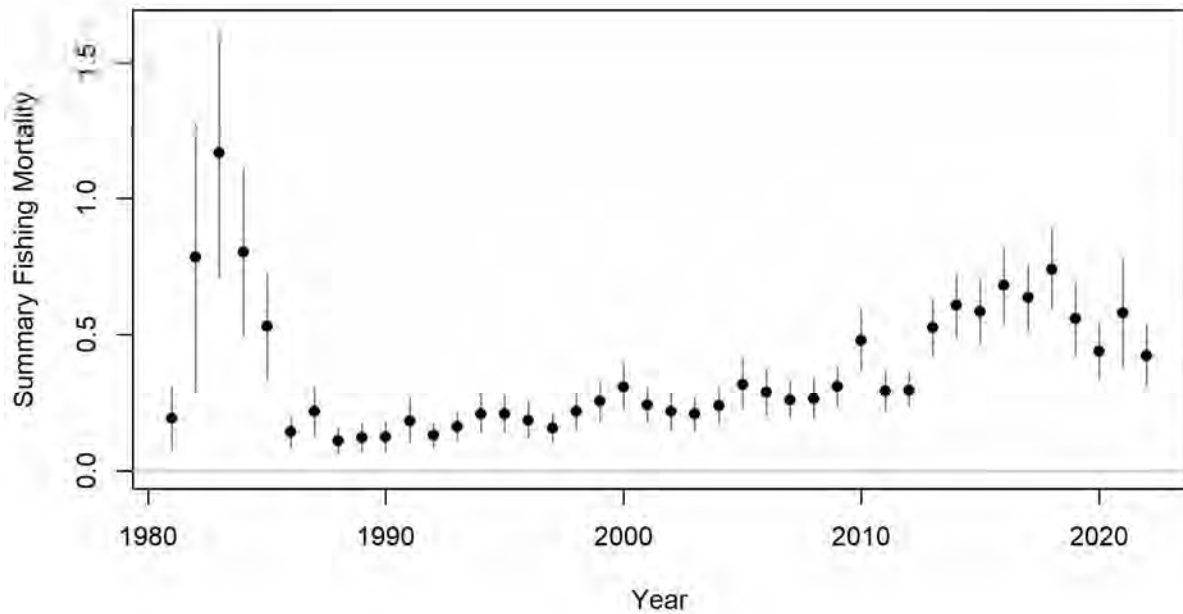
**Figure 182. Estimated female SSB (metric tons) for the southern stock SS base model. Error bars are 95% confidence intervals based on asymptotic standard errors.**



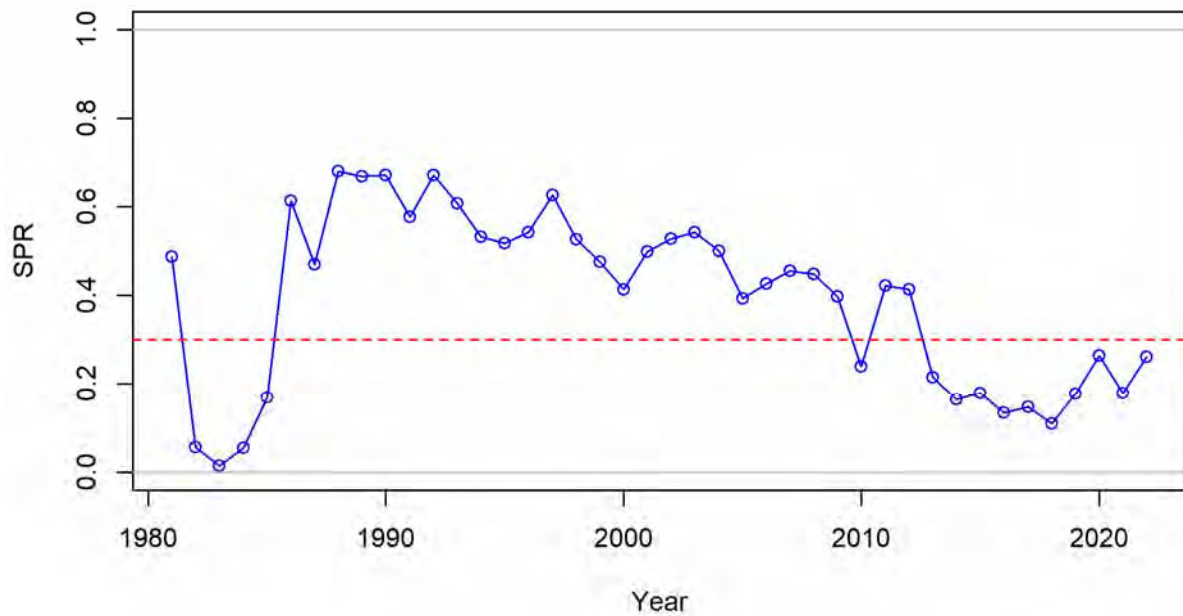
**Figure 183.** Estimated female SSB relative to the estimated SSB<sub>30%</sub> threshold for the southern stock SS base model. Error bars are 95% confidence intervals based on asymptotic standard errors.



**Figure 184.** Estimated fleet-specific fishing mortality (F) for age-2 fish for the southern stock SS base model.



**Figure 185. Total age-2 fishing mortality (F) for the southern stock SS base model. Error bars are 95% confidence intervals based on asymptotic standard errors.**



**Figure 186. SPR timeseries for the southern stock SS base model. Horizontal line is the SPR target (0.30).**

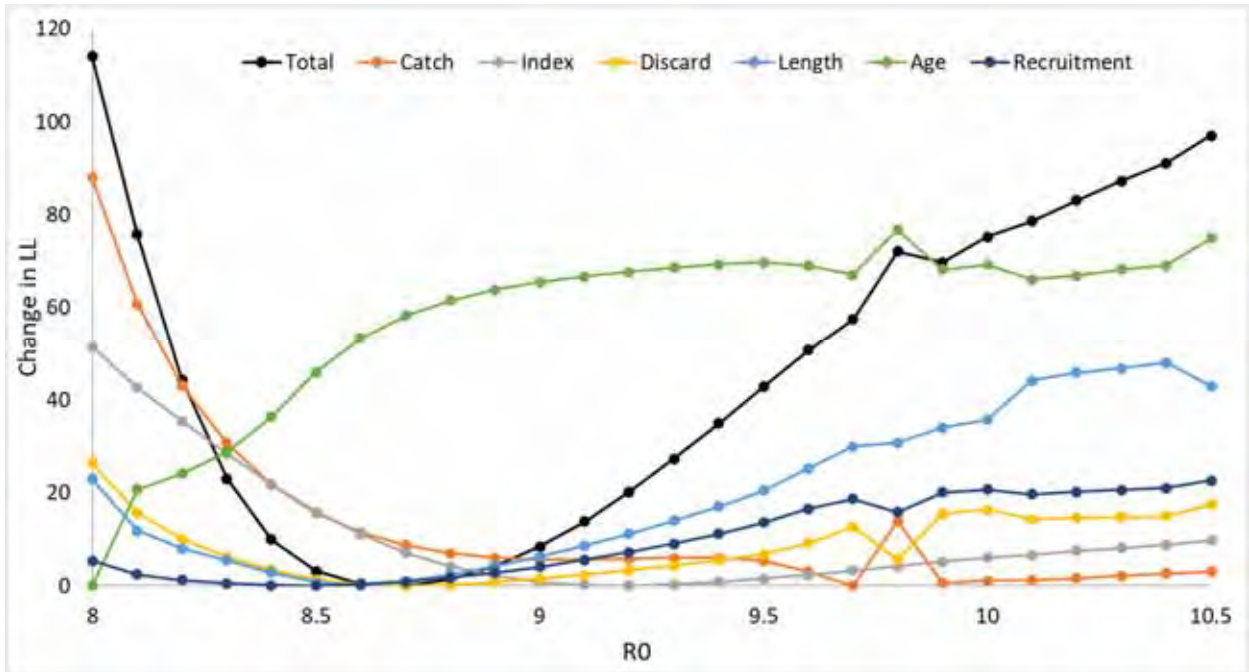
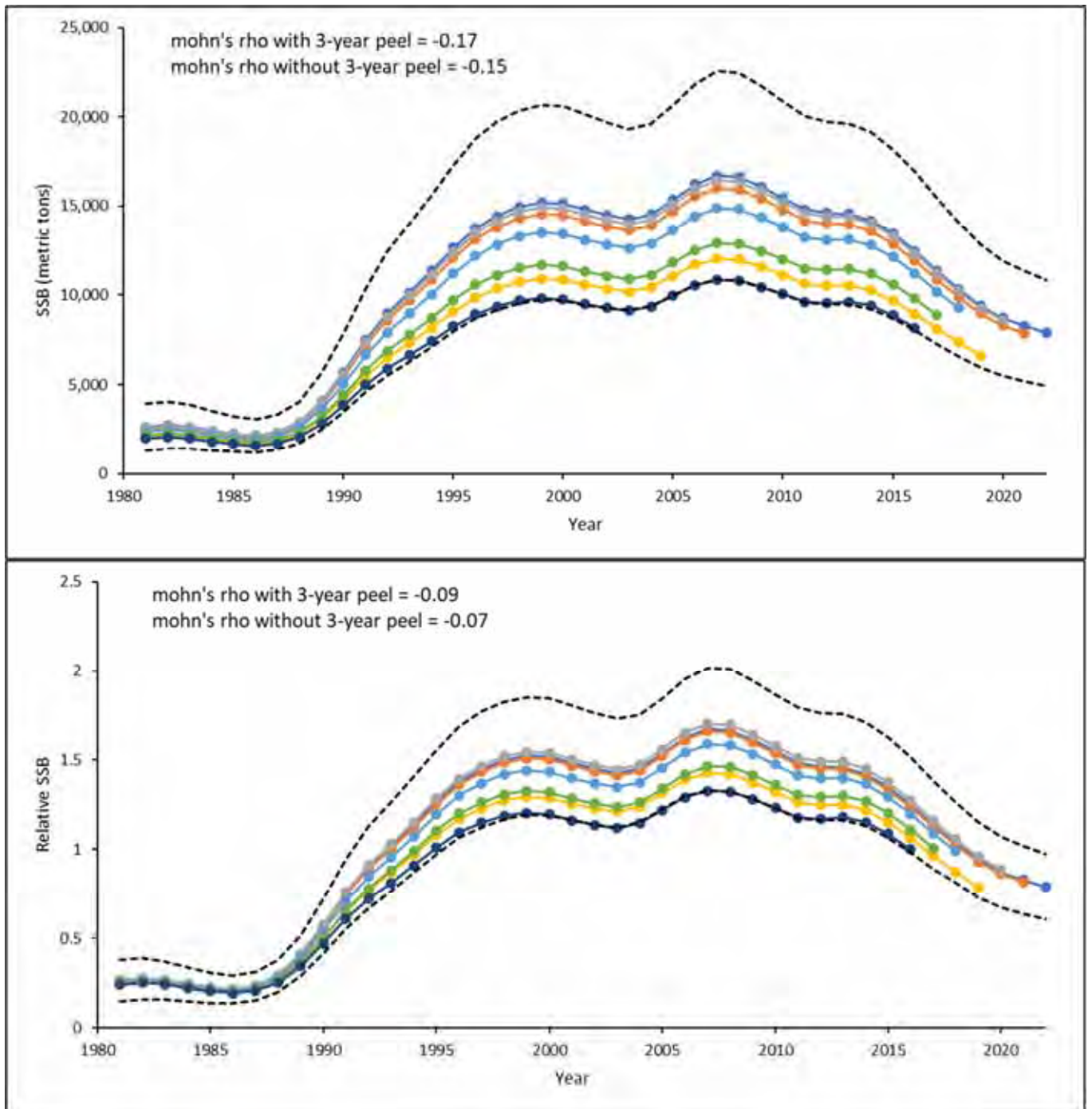
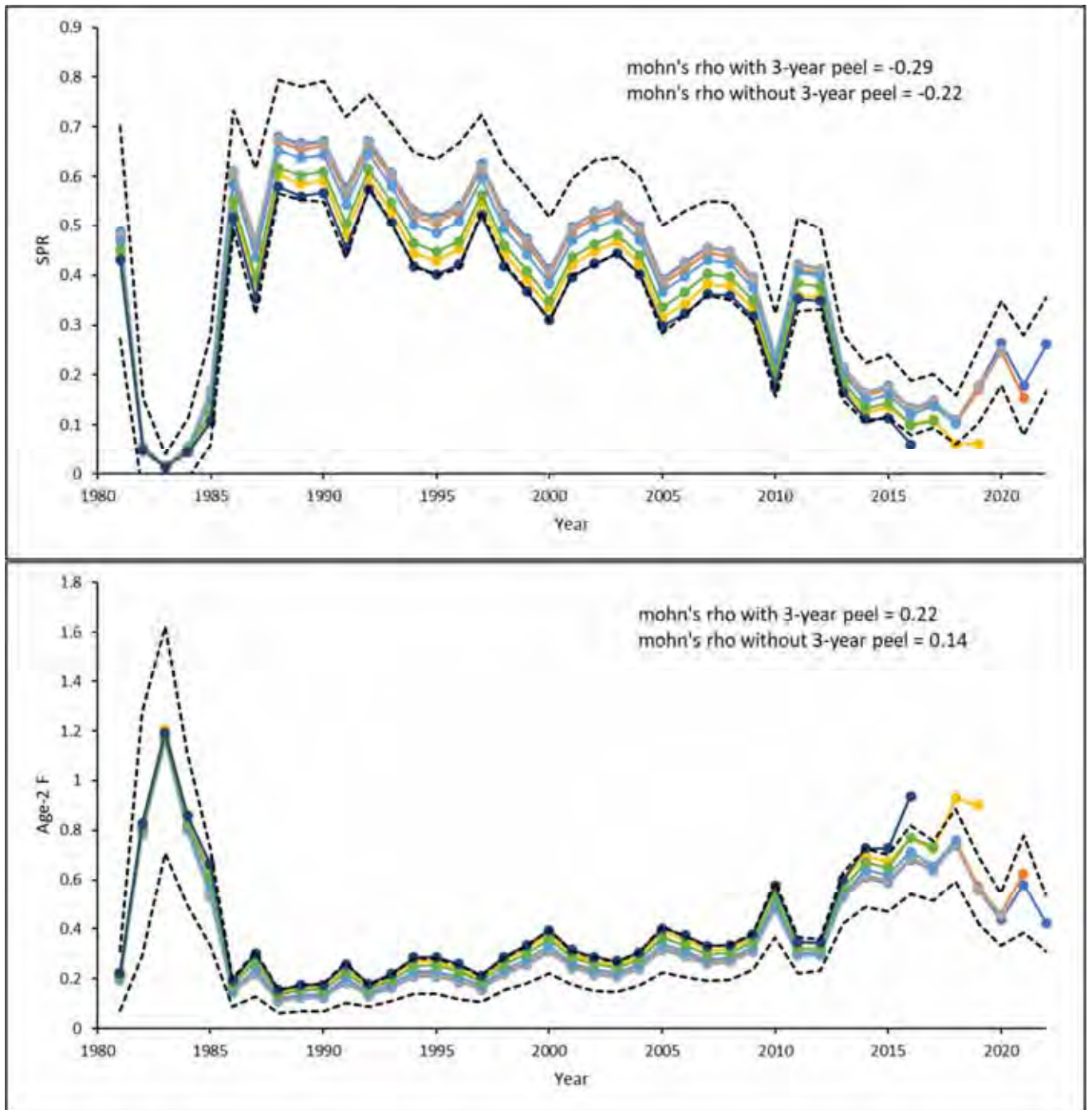


Figure 187. Likelihood profile plot for unfished recruitment (R0) parameter (on the log scale) for the southern stock SS model.

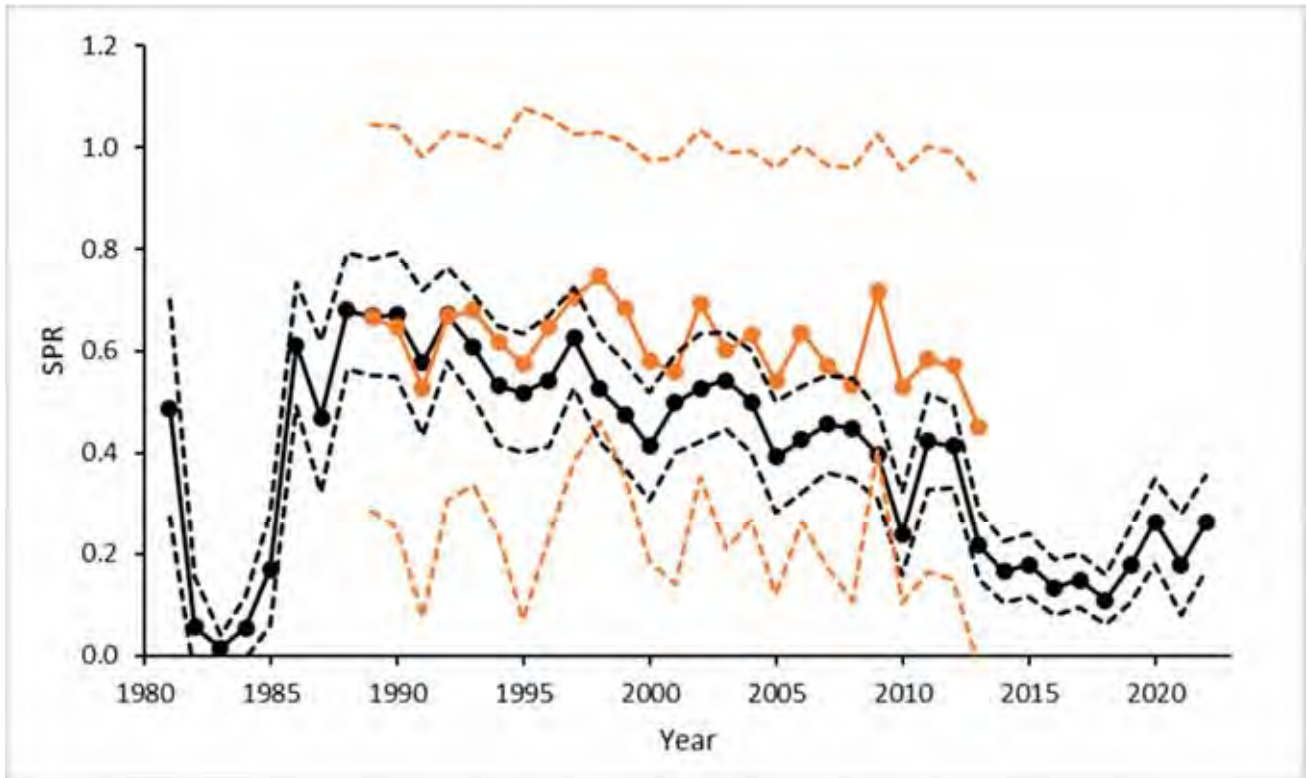




**Figure 188.** Spawning stock biomass and relative spawning stock biomass estimates from retrospective analysis of southern stock SS model. Black dashed lines are 95% confidence intervals based on asymptotic standard errors for base model estimates.



**Figure 189.** Spawning potential ratio and age-2 fishing mortality estimates from retrospective analysis of southern stock SS model. Black dashed lines are 95% confidence intervals based on asymptotic standard errors for base model estimates.



**Figure 190.** Spawning potential ratio estimates for the southern red drum stock from the previous benchmark stock assessment using a custom statistical catch-at-age model (ASMFC 2017; orange) and the current benchmark assessment SS base model (black). Dashed lines are 95% confidence intervals based on asymptotic standard errors. Estimates from the previous assessment are for calendar years while estimates in the current assessment are for fishing years.



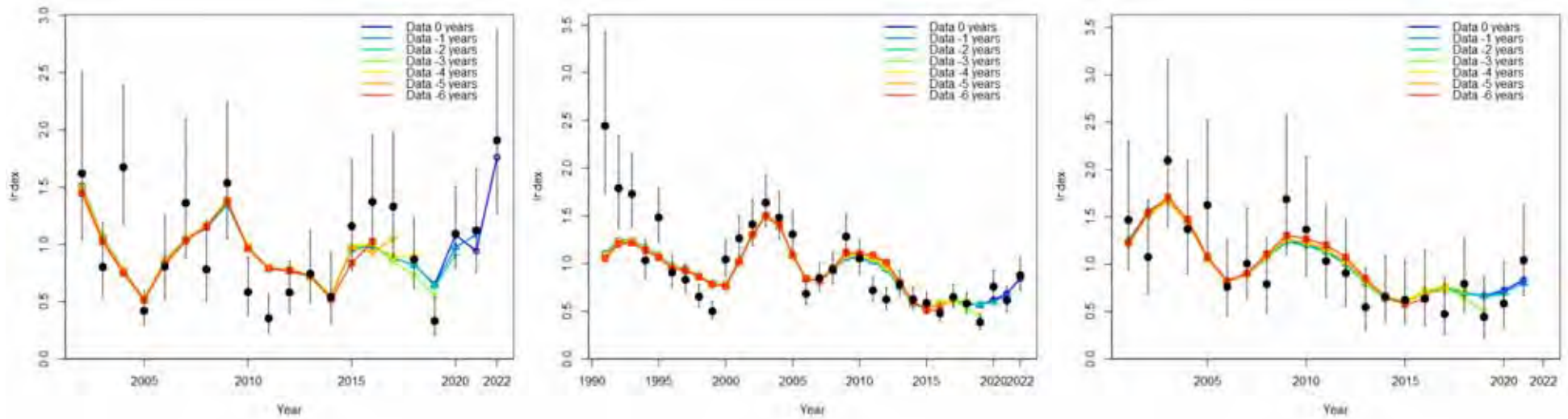
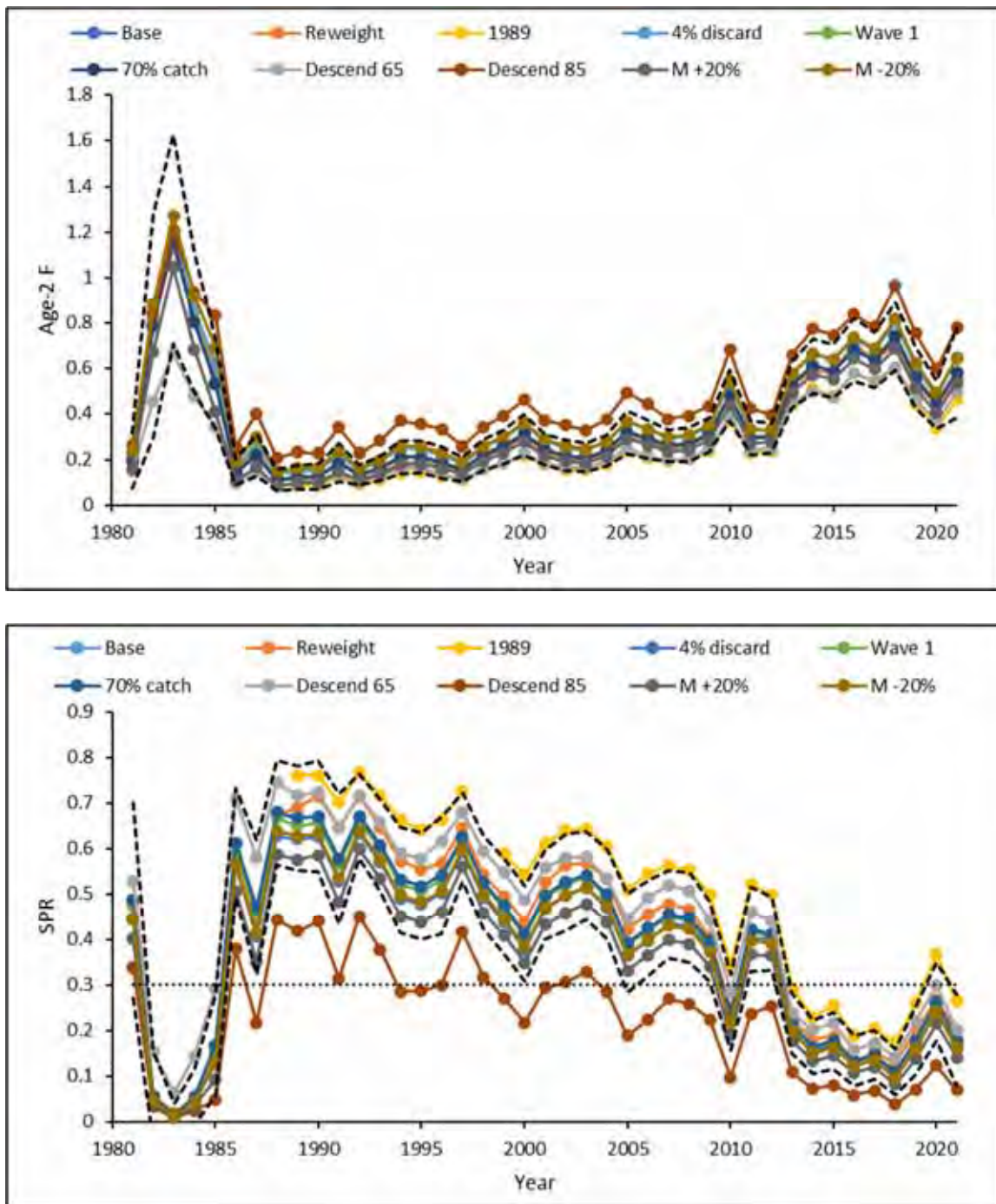
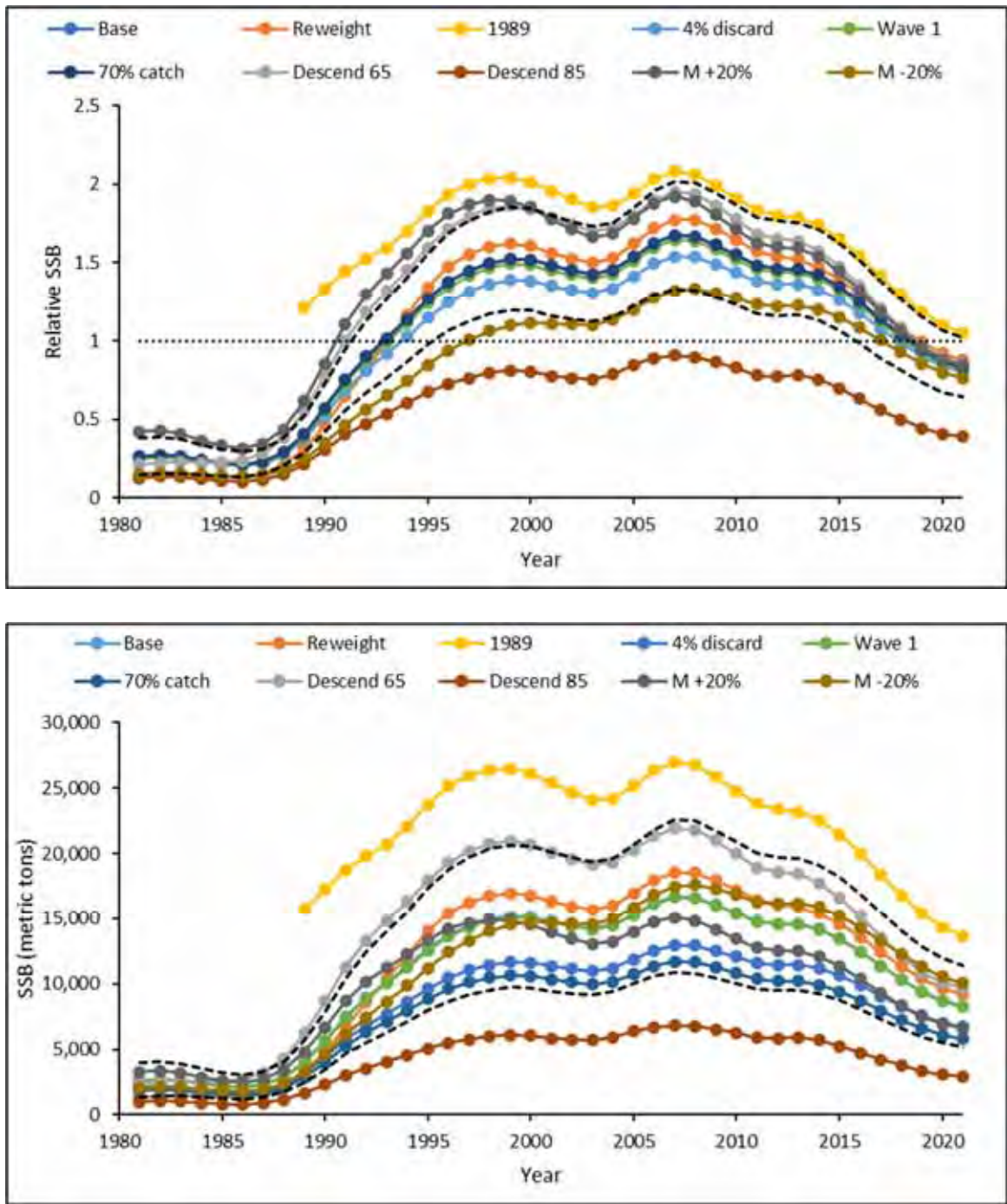


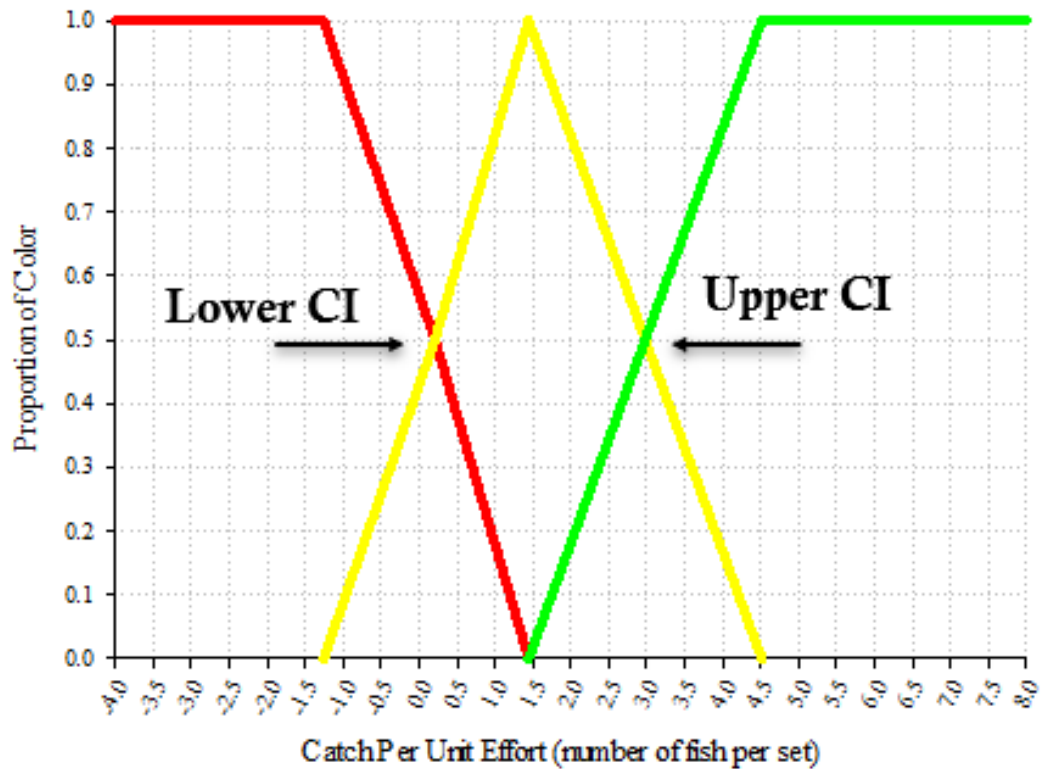
Figure 191. Observed and estimated index values for the GA\_GillNet (left), SC\_Trammel (middle), and FL\_183\_HaulSeine (right) surveys from the retrospective analysis for the southern stock SS model.



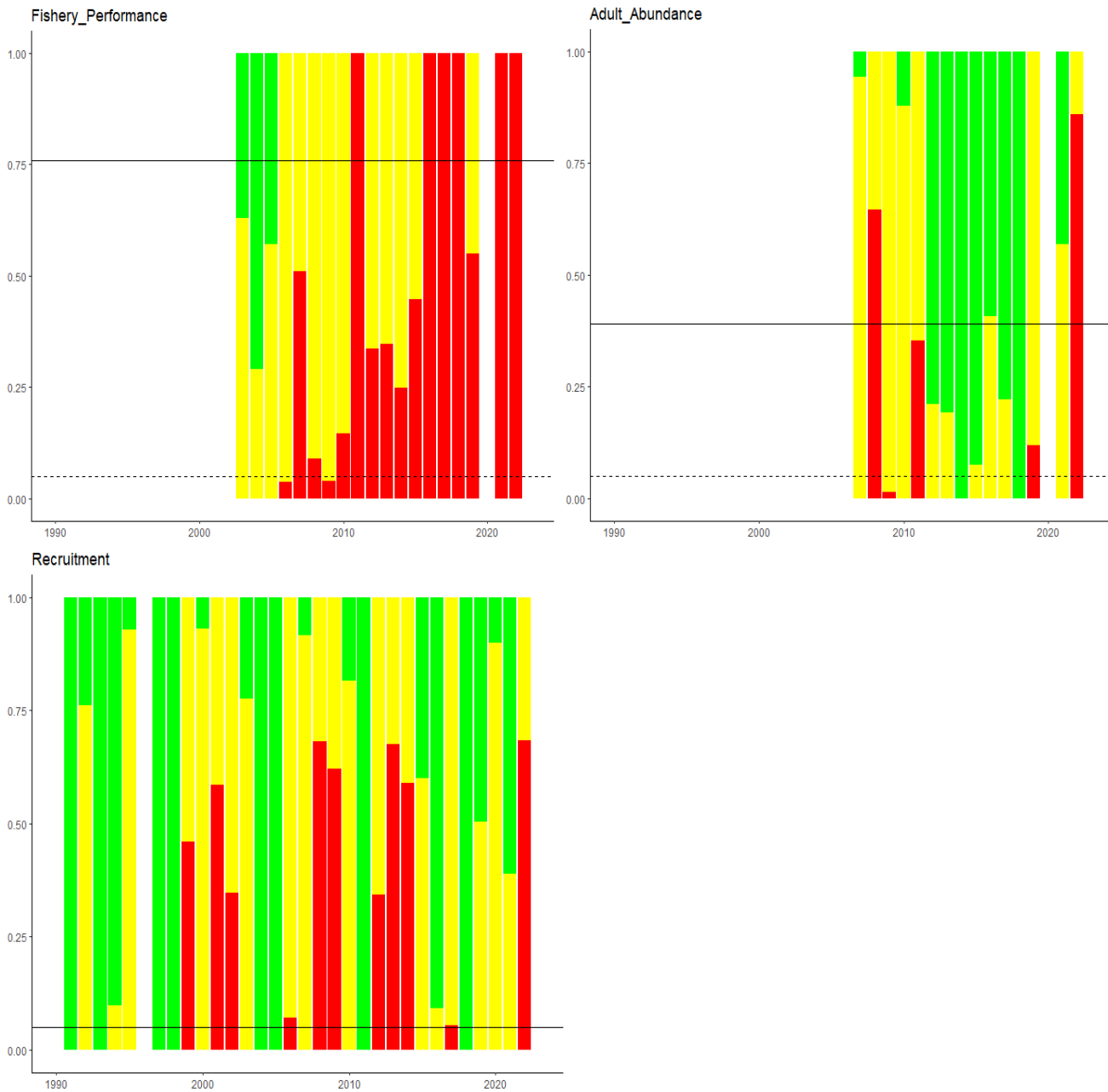
**Figure 192.** Age-2 fishing mortality and spawning potential ratio estimates from sensitivity analysis of southern stock SS model. Black dashed lines are 95% confidence intervals based on asymptotic standard errors for base model estimates. The dotted black horizontal line is the SPR threshold.



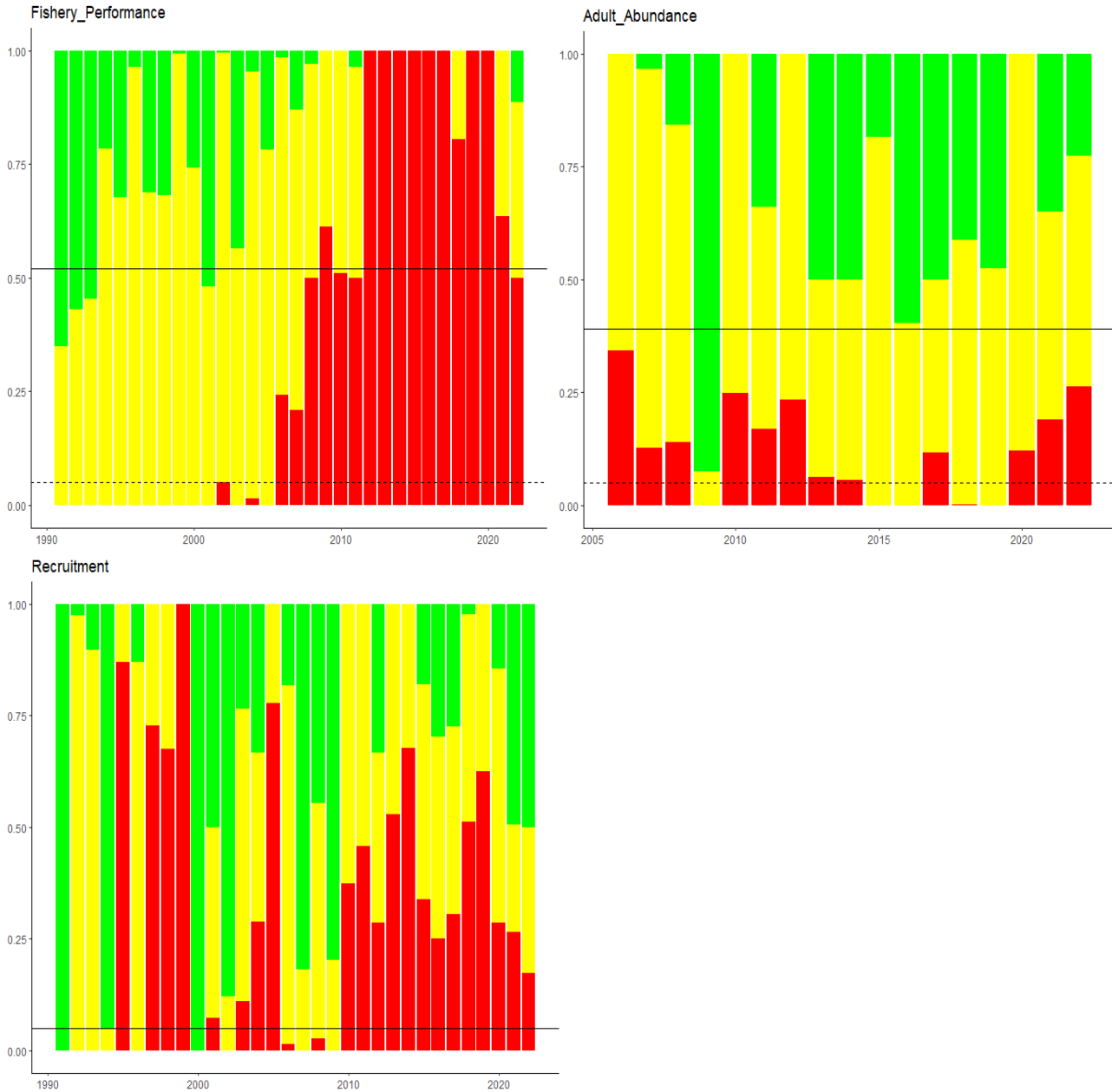
**Figure 193.** Relative spawning stock biomass and spawning stock biomass estimates from sensitivity analysis of southern stock SS model. Black dashed lines are 95% confidence intervals based on asymptotic standard errors for base model estimates. The dotted black horizontal line is the relative biomass threshold.



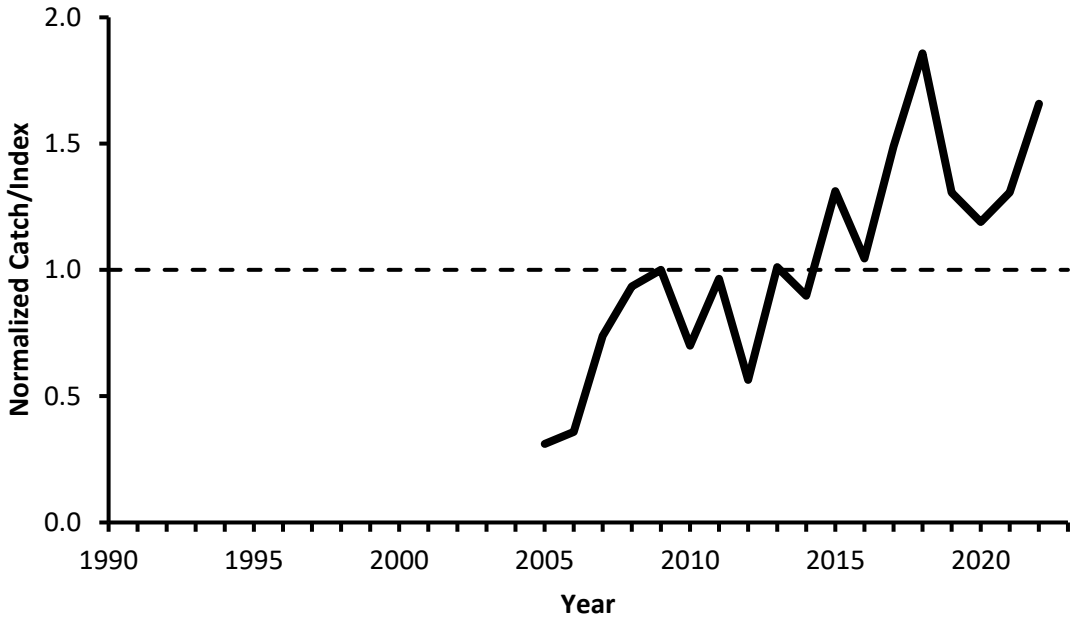
**Figure 194.** Graphical representation of traffic light analysis fuzzy method regression calculations of proportion of color using relative abundance index data. Intersection of red and yellow lines occurs at the lower 95% confidence interval and the intersection of yellow and green lines occurs at the upper 95% confidence interval. Figure adapted from ASMFC (2020).



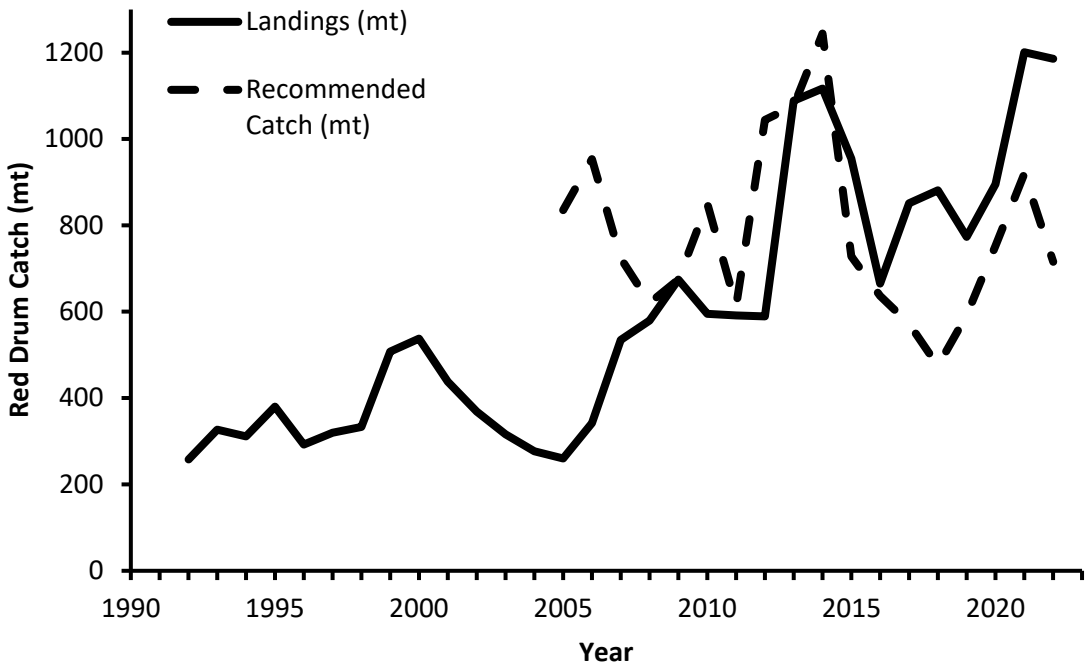
**Figure 195. Annual TLA results for each selected characteristic in the northern stock. Threshold values are represented by the solid horizontal line. The color at the threshold is the color determination for that year.**



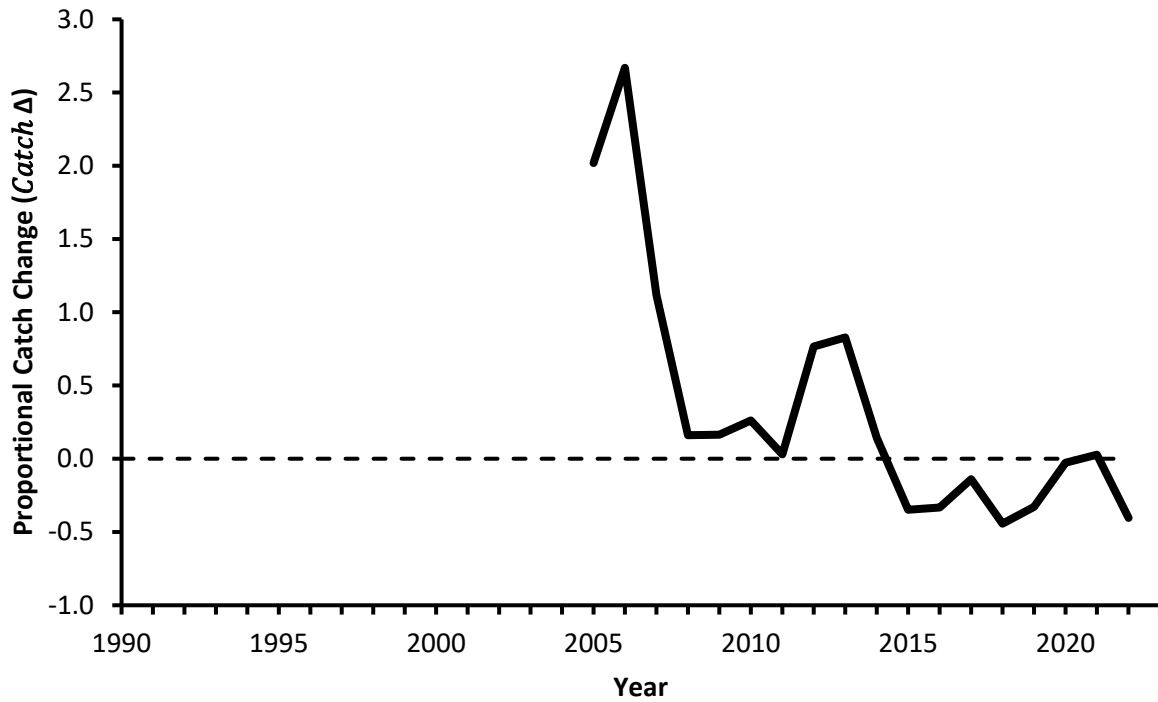
**Figure 196. Annual TLA results for each selected characteristic in the southern stock. Threshold values are represented by the solid horizontal line. The color at the threshold is the color determination for that year.**



**Figure 197.** Normalized catch:index ratio for the northern stock using MRIP data recreational harvest of red drum in North Carolina and states further north + North Carolina commercial harvest and the NCDMF gill net index.

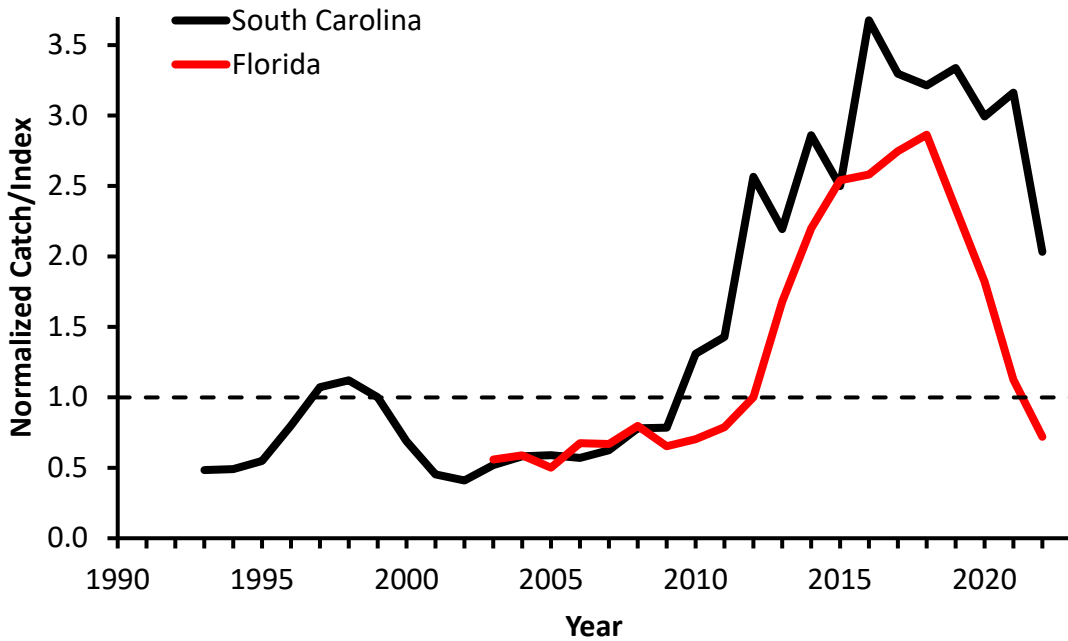


**Figure 198.** Time series of observed (solid line) and recommended (dashed line) northern stock catch based on Skate analysis using MRIP data on North Carolina and states further north recreational harvest + North Carolina commercial harvest and the NCDMF gill net index.

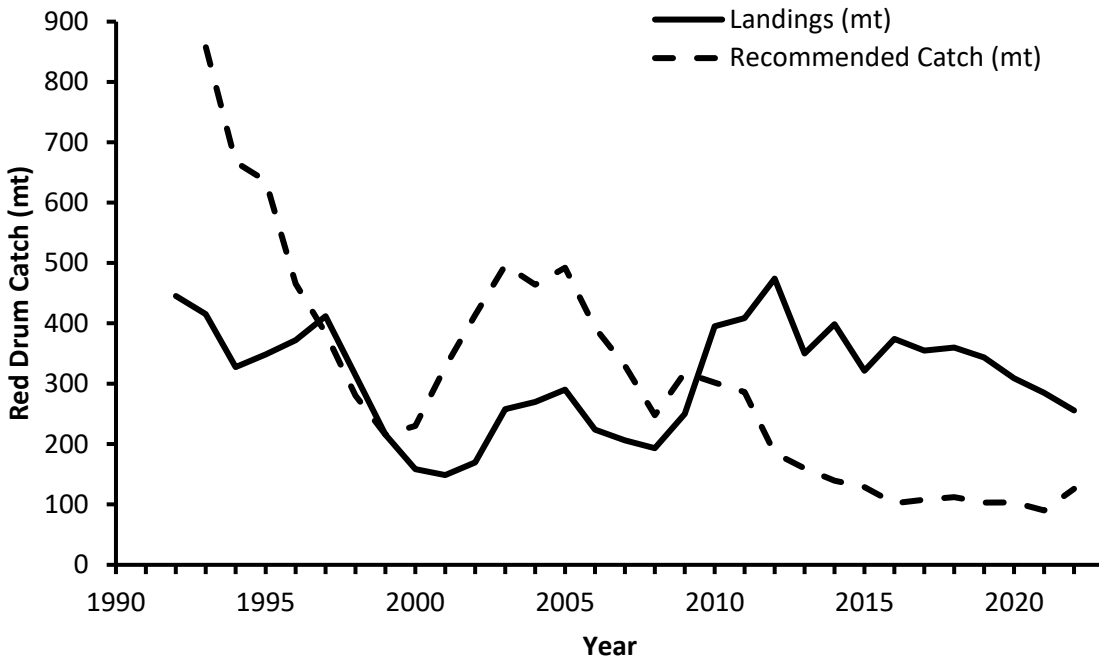


**Figure 199.** Proportional change in catch (Catch  $\Delta$ ) relative to previous fishing year as estimated for the northern stock using the Skate method. No change is denoted by the dashed line at 0, with a reduction in catch (relative to the previous year) needed when less than 0 and vice versa when above.

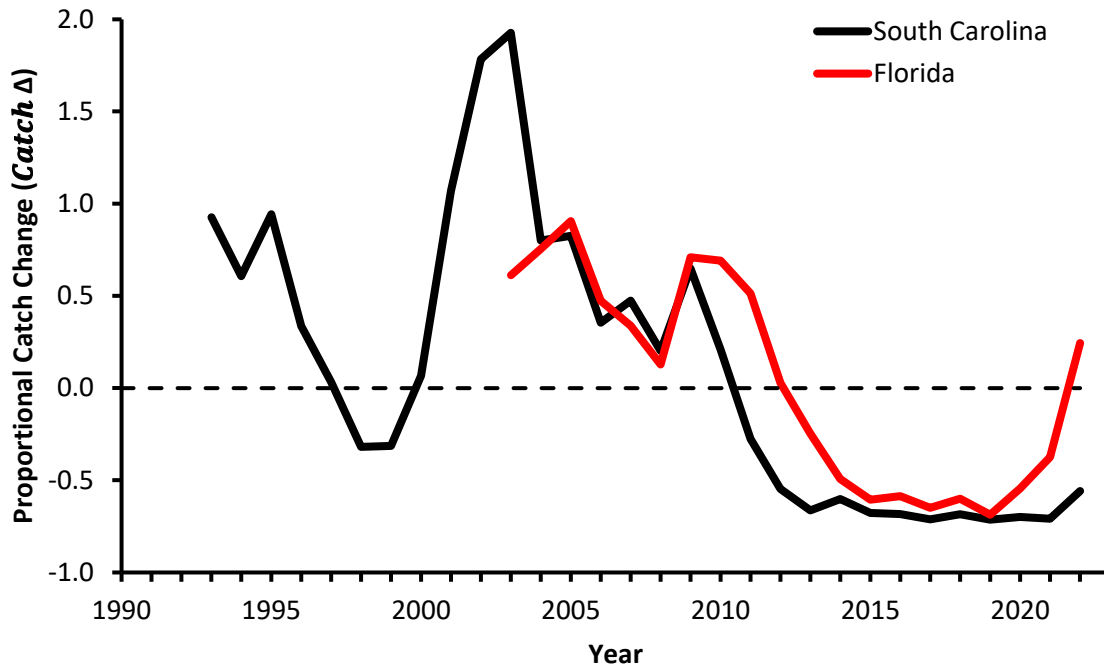




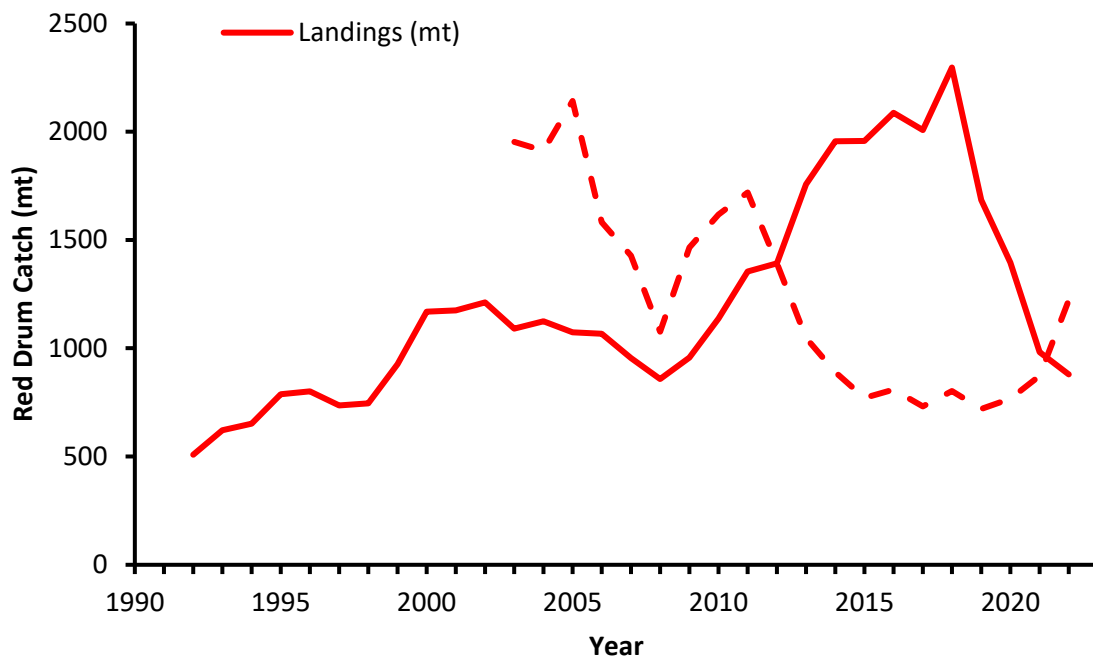
**Figure 200.** Normalized catch:index ratio for South Carolina (black line) and Florida (red line) and normalized relative F (black dashed line). South Carolina data used MRIP data on South Carolina recreational harvest and the SCDNR ages-2 and -3 trammel net index. Florida data used MRIP data on Florida recreational harvest and the FL FWRI 183 m haul seine survey.



**Figure 201.** Time series of observed (solid line) and recommended (dashed line) South Carolina catch based on Skate analysis using MRIP data on South Carolina recreational harvest and the SCDNR ages-2 and -3 trammel net index.



**Figure 202.** Proportional change in catch ( $Catch \Delta$ ) relative to previous fishing year as estimated for South Carolina (black line) and Florida (red line) using the Skate method. No change is denoted by the dashed line at 0, with a reduction in catch (relative to the previous year) needed when less than 0 and vice versa when above.



**Figure 203.** Time series of observed (solid line) and recommended (dashed line) Florida catch based on Skate analysis using MRIP data on Florida recreational harvest and the FL FWRI 183 m haul seine survey.

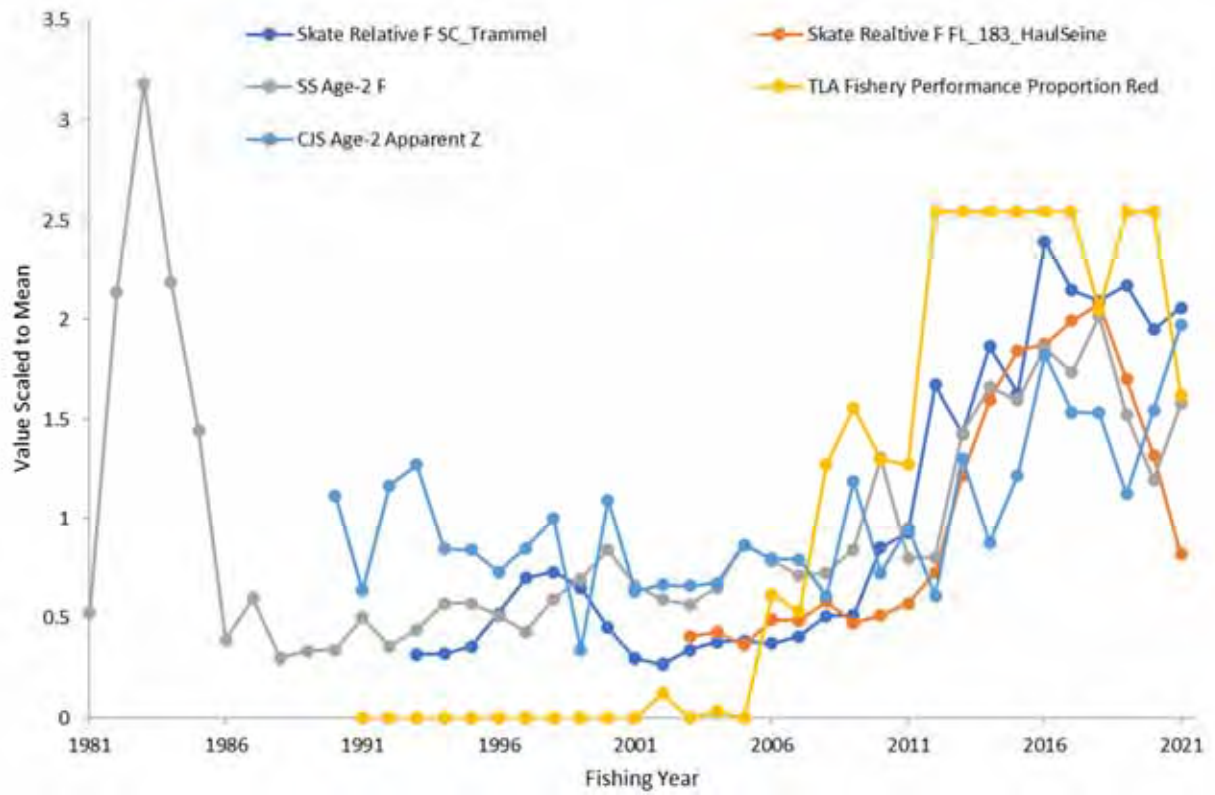


Figure 204. Comparison of scaled mortality estimates/metrics from analyses for the southern red drum stock.

## **12 APPENDIX A: OTHER DATA SOURCES CONSIDERED**

### **12.1 Fishery Dependent Data Sources**

#### **12.1.1 Commercial**

##### *Maryland Pound Net Sampling*

The Maryland Department of Natural Resources (MD DNR) has monitored commercial pound nets primarily in the Chesapeake Bay and mouth of the Potomac River since 1993. No cooperating fishermen could be located on the Potomac River in 2009 and sampling was not conducted in this area that year, but resumed in 2010. The lower portions of other rivers such as the Nanticoke and Hoga Rivers have been sampled sporadically depending on year. Generally, each site was sampled once every two weeks from May - September, weather and fisherman's schedule permitting. The commercial fishermen set their nets as part of their regular fishing activity. Net soak time and manner in which they were fished were consistent with the fisherman's day-to-day operations. All red drum captured were measured to the nearest mm TL (maximum or pinched). Other data collected includes water temperature (°C), salinity (ppt), and soak time (duration in minutes).

Red drum have been encountered sporadically throughout the 31 years of the commercial pound net survey, with none measured in nine years of the time series. Fifty-five percent of all red drum recorded by this survey were measured in 2012 (458 fish), a year of unusually high presence of red drum in the Chesapeake Bay. The TL of red drum has ranged from 187 – 1,332 mm, though almost all individuals encountered by this survey were outside of the commercial slot limit (18"-25"). None of the 458 red drum sampled in 2012 were of legal size.

Due to the limited sampling and relatively infrequent commercial harvest of red drum from Maryland waters, these data were not used in the stock assessment.

#### **12.1.2 Recreational**

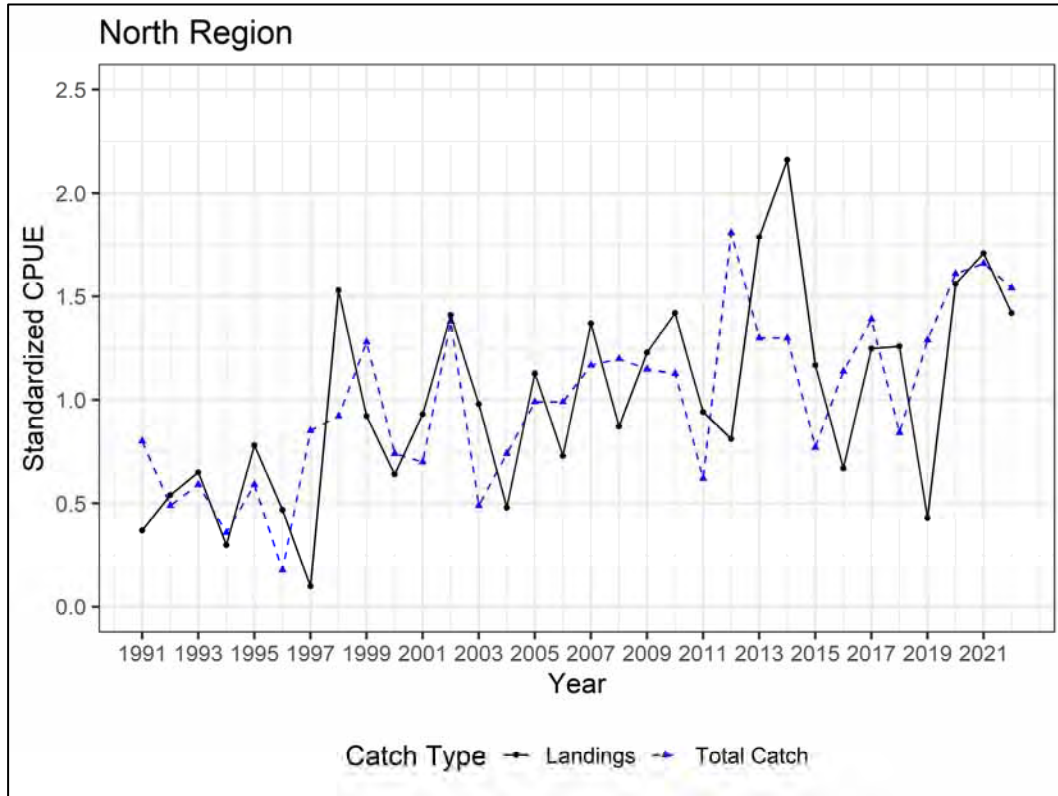
##### *MRIP CPUE*

In addition to being used for total catch estimation, catch rate data collected during MRIP APAIS sampling (Section 4.2.1) have been used to generate relative indices of abundance for past red drum stock assessments and as such were updated at the beginning of this assessment. Standardized indices to account for factors affecting nominal catch rates using only landed catch as well as total catch (landed and released alive) were calculated using similar methods to those described in Appendix 1 of ASMFC 2022.

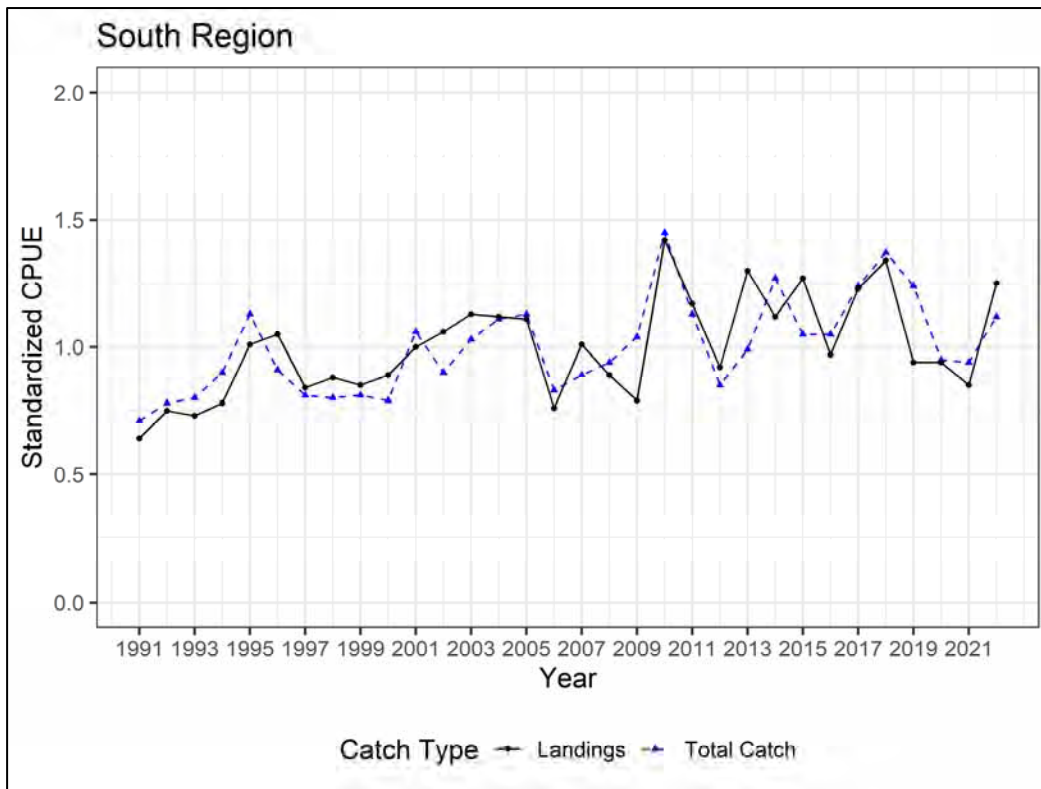
In the northern stock, catch rates increased throughout the time series, with high interannual variability (Figure A1).

In the southern stock, standardized catch rates were variable with an increasing trend across the time series (Figure A2). There was a period of decline starting in 2019, before increasing again in 2022.

During this assessment, comparisons of these FD CPUE data sets to available FI indices of abundance indicated conflicts that may represent hyperstability of the MRIP CPUE. Given the conflicts and available FI indices tracking the same components of the population, the SAS decided not to use these data sets in the stock assessment.



**Figure A1.** Standardized indices of abundance for red drum caught within inshore waters of the northern sock (Virginia and North Carolina) using hook and line gear calculated from MRIP APAIS data.



**Figure A2.** Standardized indices of abundance for red drum caught within inshore waters of the southern stock (South Carolina, Georgia, and Florida) using hook and line gear calculated from MRIP APAIS data.

*Southeast Region Headboat Survey*

The Southeast Region Headboat Survey samples the recreational fishery headboat mode in states from North Carolina through Florida to generate estimates of catch and effort. Data through 2009 was considered during the SEDAR 18 stock assessment but deemed not useful due to inconsistent and low catches. The data were revisited during this assessment to determine if any changes in catches had occurred in South Atlantic headboats. Red drum encounters remain inconsistent and low, ranging from 0-148 fish per year from 1980-2021 with 823 fish observed over the time series. These data were not included in the assessment but should be reviewed periodically in future assessments to determine if red drum catches become more substantial.

*South Carolina Charterboat Logbook Program*

In 1993, SCDNR’s Marine Resources Division (MRD) initiated a mandatory trip-level logbook reporting system for all charter vessels to collect basic catch and effort data. Under state law, vessel owners/operators purchasing South Carolina Charter Vessel Licenses and carrying fishermen on a for-hire basis, are required to submit trip level reports of their fishing activity. Logbook reports are submitted to the SCDNR Fisheries Statistics section monthly either in person, by mail, fax, or scan and beginning in 2016, electronically through a web-based

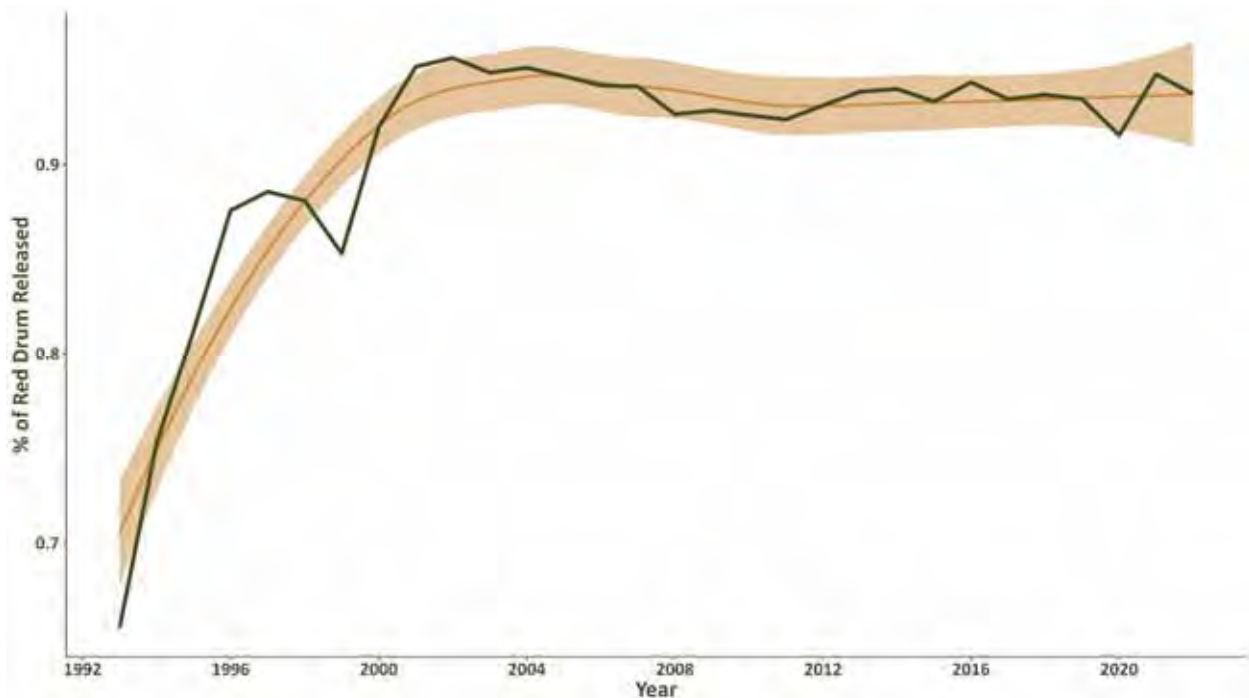
application. Reporting compliance is tracked by staff, and charter vessel owners/operators failing to submit reports can be charged with a misdemeanor. The charterboat logbook program is a complete census and should theoretically represent the total catch and effort of the charterboat trips in waters off of SC.

The charterboat logbook reports include: date, number of fishermen, fishing locale (inshore, 0-3 miles, >3 miles), fishing location (based on a 10x10 mile grid map), fishing method, hours fished, target species, depth range (minimum/maximum), catch (number of landed vs. released fish by species), and estimated landed pounds per vessel per trip. The logbook forms have remained similar throughout the program's existence with a few exceptions: in 1999 the logbook forms were altered to begin collecting the number of fish released alive and the number of fish released dead (prior to 1999 only the total numbers of fish released were recorded) and in 2008 additional fishing methods were added to the logbook forms, including cast, cast and bottom, and gig. Furthermore, the fishing method dive was added in 2012.

After being tracked for compliance, each charterboat logbook report is coded and entered, or uploaded into an existing database. Since the inception of the logbook program, a variety of staff have coded the charterboat logbook data. From ~1999 to 2006, only information that was explicitly filled out by the charterboat owners/operators on the logbook forms were coded and entered into the database. No efforts were made to fill in incomplete reports. From 2007 to present, staff have tried to fill in these data gaps through outreach with charterboat owners/operators by making assumptions based on the submitted data (i.e., if a location description was given instead of a grid location – a grid location was determined; if fishing method was left blank – it was determined based on catch, etc.). From 1999 to 2006, each individual trip recorded was reviewed to look for anomalies in the data. Starting in 2007, queries were used to look for and correct anomalous data and staff began checking a component of the database records against the raw logbook reports. Coding and QA/QC measures prior to 1999 were likely similar to those used from 1999 to present, however, details on these procedures are not available since staff members working on this project prior to 1998 are no longer with SCDNR. Data are not validated in the field and currently no correction factors are used to account for reporting errors via paper submission; however, the online system is built with error messages and constraints to prevent common reporting mistakes and overlaps in the data. Recall periods for logbook records are typically one month or less. However, in the case of delinquent reports, recall periods could be up to several months. The electronic reporting application has already shown a decrease in recall bias.

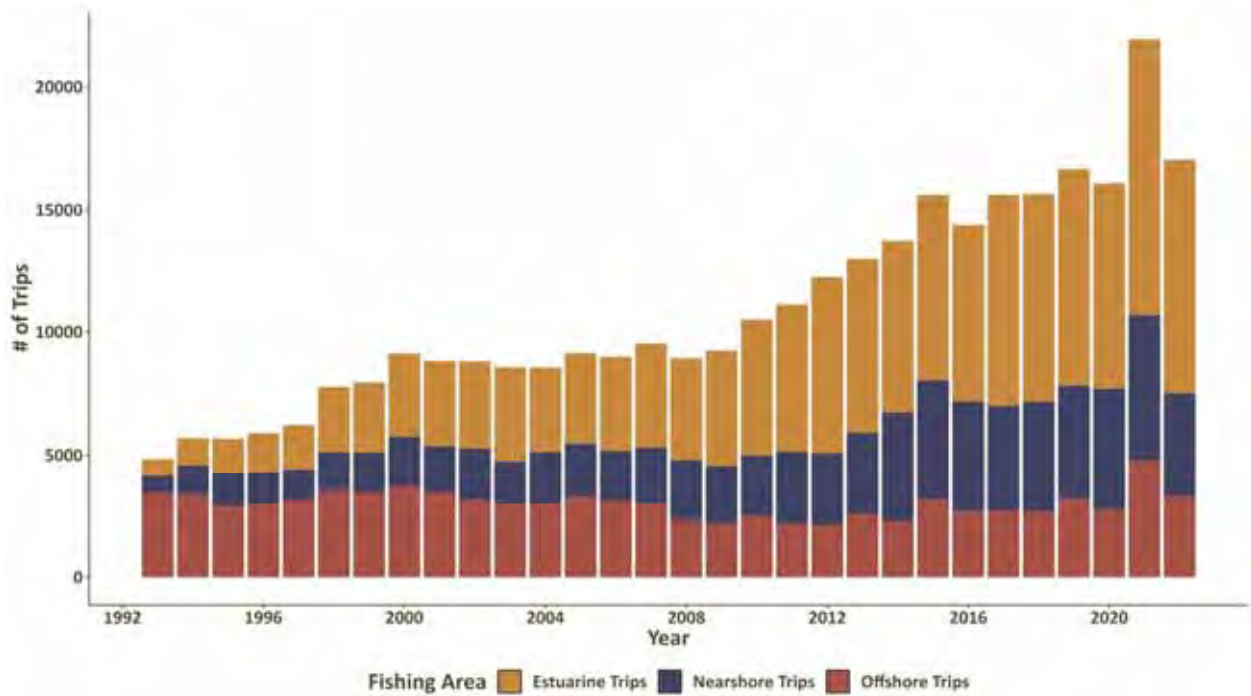
Through 2022, the charterboat logbook program had logged 238,270 charterboat trips across South Carolina, with red drum being caught in 129,817 individual trips (~54% of all trips). The positive trips reported the capture of 963,786 fish, with 65,778 (7%) harvested and 898,008 released (Figure A3). Note, South Carolina charterboat owners/operators have developed a strong catch-and-release ethic for red drum (and other species) over time, with most captains either requiring or strongly suggesting catch and release for even legal-sized fish since the early 2000s. This has led to a reported release rate increasing from ~70% in the mid-1990s to >95% since the early 2000s across the South Carolina charterboat fleet (Figure A3).

As a census of the catch and effort of the South Carolina charterboat owners/operators, the SCDNR charterboat logbook program has several potential uses in stock assessments of red drum, including as a mechanism to understand temporal changes in fishermen behavior with regards to fishing practices, fishing locations, and within year timing of fishing activities. Cursory investigations of the charterboat logbook data suggests shifts in charterboat owner/operators behavior through time, with an increase in the rate of catch-and-release fishing practices (Figure A3) as well as a shift to more effort to nearshore waters (Figure A4, Figure A5, and Figure A6), which given red drum life history suggests increasing fishing pressure on the adult component of the red drum stock found along coastal South Carolina.

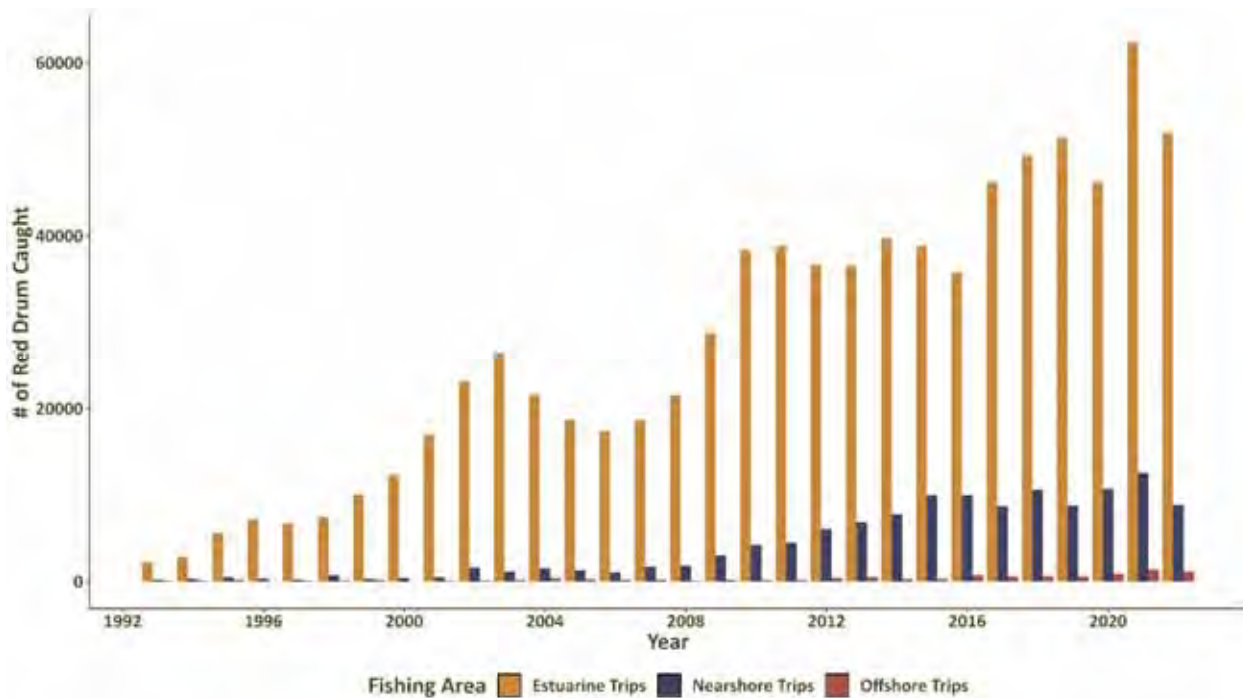


**Figure A3.** Proportion of red drum reported released alive annually by the SCDNR charterboat logbook program. Shown is an annual estimate (solid green line) and a LOESS smoother of annual estimates with 95% confidence interval (orange line and orange shaded region, respectively).

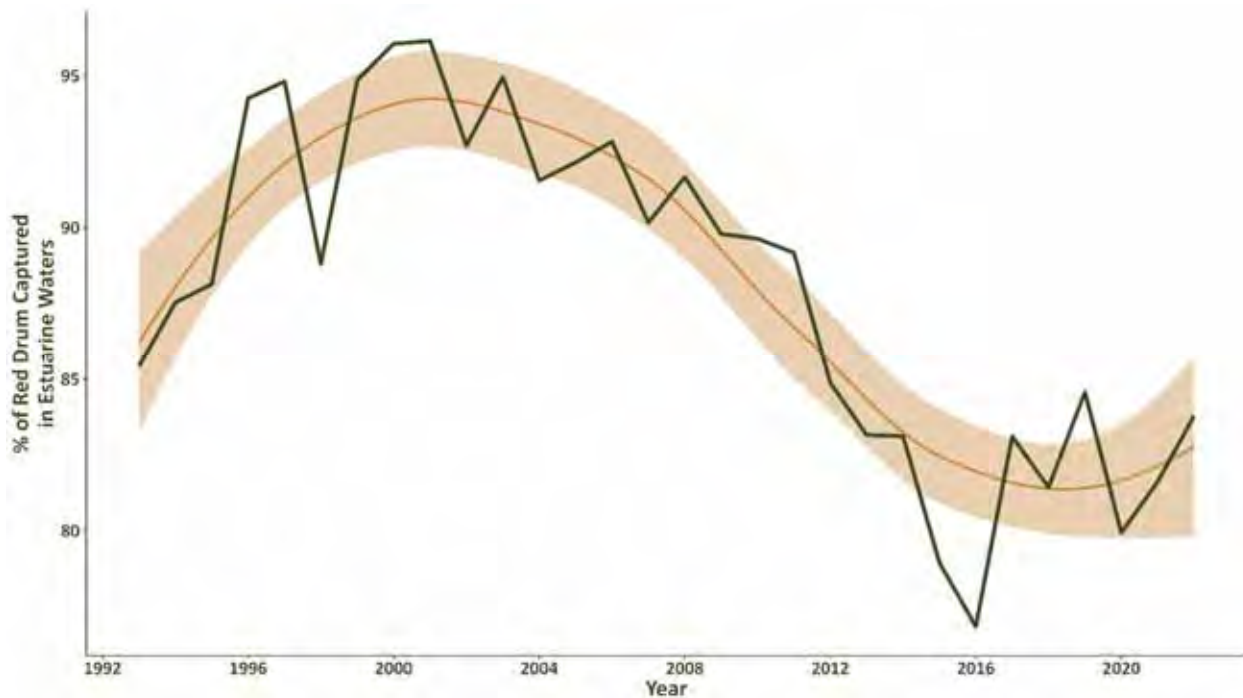




**Figure A4.** Annual trips by geographic area made by charter boat anglers across coastal South Carolina. Note, these are all trips regardless of target species but given 54% of all trips reported capturing at least one red drum and the occurrence of zero catch trips, the general pattern is representative of general shifts in geographic focus of targeting of red drum through time.



**Figure A5.** Number of reported red drum caught annually in estuarine (orange), nearshore (blue), and offshore (red) charterboat trips as reported by the SCDNR charterboat logbook program.

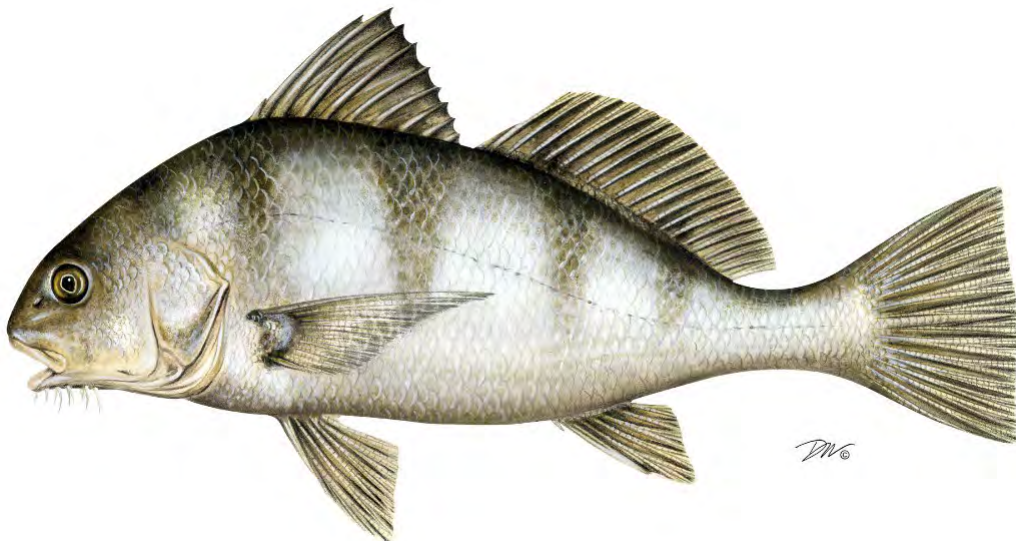


**Figure A6.** Percent of red drum captured annually in estuarine waters as reported by the SCDNR charterboat logbook program. Shown is the annual percentage of fish reported harvest in estuarine waters (green line) as well as a LOESS smoother of annual estimates depicting smoothed annual estimates and 95% confidence intervals of estimates (orange line and orange shaded region, respectively).

**ATLANTIC STATES MARINE FISHERIES COMMISSION**  
**REVIEW OF THE INTERSTATE FISHERY MANAGEMENT PLAN**

**FOR BLACK DRUM**  
***(Pogonias cromis)***

**2023 FISHING YEAR**



Prepared by the Plan Review Team  
Drafted September 2024



*Sustainable and Cooperative Management of Atlantic Coastal Fisheries*

## Table of Contents

I.	Status of the Fishery Management Plan.....	1
II.	Status of the Stocks .....	2
III.	Status of the Fishery.....	2
IV.	Status of Assessment Advice .....	3
V.	Status of Research and Monitoring .....	4
VI.	Status of Management Measures and Issues .....	4
VII.	Implementation of FMP Compliance Requirements for 2023 .....	4
VIII.	Recommendations of the Plan Review Team .....	5
IX.	References .....	5
X.	Figures.....	6
XI.	Tables .....	8

## I. Status of the Fishery Management Plan

<u>Date of FMP Approval:</u>	Original FMP – June 2013
<u>Addendum:</u>	Addendum I – May 2018
<u>Management Areas:</u>	The entire Atlantic coast distribution of the resource from New Jersey through the east coast of Florida
<u>Active Boards/Committees:</u>	Sciaenids Management Board; Black Drum Technical Committee; Plan Review Team; South Atlantic Species Advisory Panel

The Atlantic States Marine Fisheries Commission (ASMFC) adopted an [interstate Fishery Management Plan \(FMP\) for Black Drum in 2013](#). Prior to the FMP, management was state-specific, from no regulations in North Carolina to various combinations of size limits, possession limits, commercial trip limits, and/or annual commercial quotas from New Jersey to Florida. While the Maryland portion of the Chesapeake Bay was closed to commercial fishing in 1998, it was reopened in 2019 via Addendum 1 which was approved in 2018.

The FMP requires all states with a declared interest in the species to have established a maximum possession limit and minimum size limit of at least 12 inches total length (TL) by January 1, 2014, and to have increased the minimum size limit to at least 14 inches TL by January 1, 2016. The FMP also includes a management framework to adaptively respond to future concerns or changes in the fishery or population.

There are four plan objectives:

- Provide a flexible management system to address future changes in resource abundance, scientific information, and fishing patterns among user groups or area.
- Promote cooperative collection of biological, economic, and sociological data required to effectively monitor and assess the status of the black drum resource and evaluate management efforts.
- Manage the black drum fishery to protect both young individuals and established breeding stock.
- Develop research priorities that will further refine the black drum management program to maximize the biological, social, and economic benefits derived from the black drum population.

The management unit for black drum under the FMP is defined as the range of the species within U.S. waters of the northwest Atlantic Ocean, from the estuaries eastward to the offshore boundaries of the Exclusive Economic Zone (EEZ).

In 2018, [Addendum I](#) allowed Maryland to reopen their commercial fishery in the Chesapeake Bay, starting in the 2019 fishing year (ASMFC 2018). Prior to this addendum, a commercial moratorium

was in place for these waters due to the FMP's requirement that states maintain measures in place at the time of the FMP's approval.

## **II. Status of the Stocks**

The most recent coastwide benchmark stock assessment for black drum, which incorporated data through 2020, was accepted in 2023 by the Sciaenids Management Board for management use. Based on assessment results, the black drum stock is not overfished and not experiencing overfishing. Management action was not taken because there are no major concerns with the stock.

The assessment model, JABBA-Select, uses recreational CPUE as an index of abundance, total fishery removals (commercial landings, recreational harvest, and recreational dead discards), life history information, and selectivity information to estimate black drum spawning biomass and exploitation (i.e., the proportion of stock biomass removed by fishing), as well as their associated thresholds. The assessment model estimated increasing spawning biomass, which has remained above the spawning biomass threshold throughout the time series (Figure 1). Exploitation has remained below the exploitation threshold throughout the time series. Exploitation was estimated to be relatively high in the mid-1980s, followed by lower levels throughout the 1990s. Exploitation increased around 2000 and remained at a higher, stable level throughout the remainder of the time series. Overall, black drum remains a data poor stock and the assessment acknowledges a relatively high level of uncertainty in available data sets and population estimates, although there is greater certainty in qualitative stock status determinations.

Due to data limitations and assessment uncertainty, a suite of indicators from black drum data sets developed as part of this assessment will be used to annually monitor the stock for any concerning trends and identify the need for an expedited stock assessment. Indicators include eight indices of abundance, one index of range expansion, and six indices of fishery characteristics (i.e., regional catch time series). The assessment reviewed the indicators through 2020. The indicators show increased fishery removals in the last twenty years and less frequent large recruitment events in the Mid-Atlantic in the last ten years. There are no clear indications of a declining trend in abundance from abundance indicators, but there is a declining trend in the final two years of the recreational releases time series that may be reflective of abundance in addition to other factors. There is some indication of northern range expansion. Overall, stock indicators did not appear negative.

After the assessment was complete, the indicators were updated with data through 2022. Overall, indicators show mixed signs of stability and declines since the assessment. Despite some observed declines in a few of the indicators, in each case the two additional years of data were still within the historical range of that indicator. The TC did not express concern at this time and recommended no changes to the current black drum stock assessment schedule, but to continue to closely monitor the indicators. The Board agreed with the TC's recommendations.

## **III. Status of the Fishery**

Total black drum landings from New Jersey through the east coast of Florida are estimated at 5.5 million pounds in 2023, a 6% increase from total harvest in 2022 (Tables 2 and 3; Figure 2). The 2023 harvest is slightly below the previous ten-year (2013-2022) average. The commercial and recreational fisheries harvested 6% and 94% of the 2023 total, respectively.

Commercial landings of black drum in 2023 spanned from New York through Florida. Although landings from outside the management unit (i.e., north of New Jersey) were less than 1% of the coastwide total, commercial landings in states north of the management unit have increased marginally and become more frequent in the last 10-15 years; black drum have been observed spawning in areas northward of Great Bay, NJ. Coastwide commercial landings show no particular temporal trends, ranging from approximately 82,000 pounds in 1985 to 556,000 pounds in 2002 annually since 1981 (Figure 2). Black drum commercial landings in 2023 were 347,506 pounds, a 42% increase from 2022. North Carolina led commercial harvest with 69% of the landings, followed by Virginia with 21% (Table 2).

Recreational harvest of black drum peaked by weight in 2008 at 10.7 million pounds (Table 3) and by numbers of fish in 2003 at 2.9 million (Table 4). Overall, landings have ranged between 650 thousand pounds in 1988 and 10.7 million pounds in 2008, and numbers of fish have fluctuated between 260,000 in 1989 and 2.9 million fish in 2003 (Figures 3 and 4).

The 2023 recreational harvest (1.2 million fish or 5.2 million pounds) represents a 46% increase in numbers and a 5% increase in pounds from 2022. Florida anglers landed the largest share of the coastwide recreational harvest in numbers (60%), followed by North Carolina (19%). No recreational harvest was estimated in New Jersey in 2023, the first time since 2000.

Since the beginning of the time series (1981), recreational anglers have released increasing percentages of black drum, with percentages of fish released exceeding 70% seven times in the past ten years. In 2023, 69% (2.7 million fish) of the recreational catch was released (Figure 3; Table 5). It is worth noting that release rates increased substantially after 2013, when the FMP established minimum sizes in every state and required that undersized drum be released for the first time. Recent high release rates can be attributed to these measures, as well as encouragement of catch and release practices.

#### **IV. Status of Assessment Advice**

Current stock status information comes from the 2023 benchmark stock assessment (ASMFC 2023) completed by the ASMFC Black Drum Stock Assessment Subcommittee and Technical Committee, peer reviewed by an independent panel of experts, and approved by the Sciaenids Management Board for use in management decisions. It has a terminal year of 2020.

The [assessment report](#) outlines several data and research needs that would improve the next benchmark assessment, such as the need for a fishery-independent adult survey and associated biological data, expansion of current tagging programs, and increased biological sampling in commercial and recreational fisheries.

The favorable stock status estimates from the 2023 benchmark stock assessment indicate that no immediate management action is needed. However, black drum remains a data-poor stock and the assessment acknowledges a relatively high level of uncertainty in available data sets and quantitative population estimates despite greater certainty in qualitative estimates of stock status (i.e., overfished vs. not overfished and overfishing occurring vs. overfishing not occurring). Due to this uncertainty, the stock assessment recommends that stock indicators as established in the Black Drum Benchmark Stock Assessment and Peer Review Report be reviewed annually by the Sciaenids Management Board to closely monitor the stock for any concerning trends between stock assessments. It is recommended that the next benchmark assessment should be conducted in five years.

## **V. Status of Research and Monitoring**

There are no monitoring or research programs required annually of the states except for the submission of a compliance report. The following fishery-dependent (other than catch and effort data) and fishery-independent monitoring programs were reported in the 2024 reports. Delaware, Maryland, Virginia, North Carolina, South Carolina, Georgia, Florida, and National Marine Fisheries Service have fishery-dependent monitoring for black drum. States that encounter fish through fishery-independent monitoring include New Jersey, Delaware, Maryland, North Carolina, South Carolina, Georgia, and Florida.

## **VI. Status of Management Measures and Issues**

### *Fishery Management Plan*

The Black Drum FMP required all states with a declared interest in the species to have established a maximum possession limit and minimum size limit of at least 12 inches TL by January 1, 2014, and to have increased the minimum size limit to no less than 14 inches TL by January 1, 2016.

### *De Minimis*

The black drum FMP allows states to request *de minimis* status if, for the preceding three years for which data are available, their average combined commercial and recreational landings (by weight) constitute less than 1% of the average coastwide commercial and recreational landings for the same three-year period. A state that qualifies for *de minimis* will qualify for exemption in both their commercial and recreational fisheries.

### *De Minimis Requests*

No state requested *de minimis* status through the annual reporting process.

### *Recent Changes to State Management*

None in 2023.

## **VII. Implementation of FMP Compliance Requirements for 2023**



The PRT found no inconsistencies between state compliance reports and requirements of the Fishery Management Plan.

## **VIII. Recommendations of the Plan Review Team**

Research recommendations can be found in the [2023 Black Drum Benchmark Stock Assessment and Peer Review Report](#).

### Management and Regulatory Recommendations

- Begin or continue biological sampling to collect age and size composition from both recreational and commercial fisheries as well as fecundity data. Data gaps include size and age of discards, catch and release mortality, age and size-specific fecundity, spawning frequency, and spawning behaviors by region.
- Continue and expand current tagging programs to obtain mortality and growth information and movement at size data, and consider conducting a high reward tagging program to obtain improved return rate estimates. Tagging studies that utilize implanted radio tracking tags compatible with coastal tracking arrays along the Atlantic coast in order to track movement and migration of adults and juveniles would also help fill the data needs.

## **IX. References**

ASMFC. 2013. Interstate Fishery Management Plan for Black Drum. Arlington, VA. 72 p.

ASMFC. 2015. Black Drum Stock Assessment for Peer Review. Atlantic States Marine Fisheries Commission, Stock Assessment Report. 352 p.

ASMFC. 2018. Addendum I to the Black Drum Interstate Fishery Management Plan. Arlington, VA. 4 p.

ASMFC. 2023. [Black Drum Benchmark Stock Assessment and Peer Review Report](#). Atlantic States Marine Fisheries Commission. Arlington, VA. 299 p.

Winker, H., F. Carvalho, J.T. Thorson, L.T. Kell, D. Parker, M. Kapur, R. Sharma, A.J. Booth, and S.E. Kerwath. 2020. JABBA-Select: Incorporating life history and fisheries' selectivity into surplus production models. Fisheries Research 222.

X. Figures

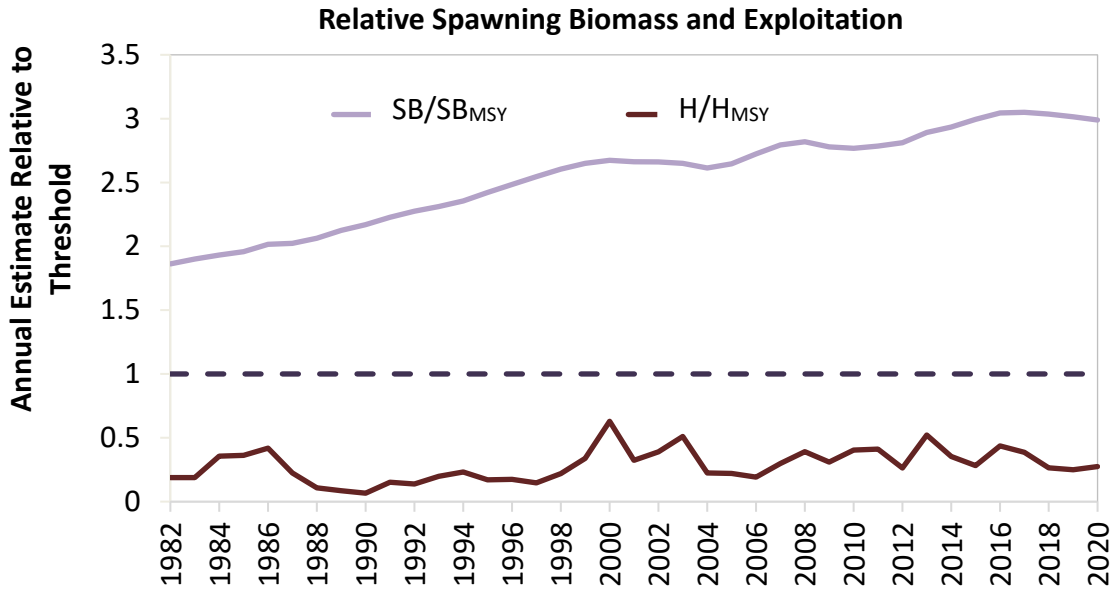


Figure 1. JABBA-Select annual estimates of spawning biomass ( $SB/SB_{MSY}$ ) and exploitation ( $H/H_{MSY}$ ) relative to the threshold (dashed line), from 1982-2020 (Source: ASMFC 2023).

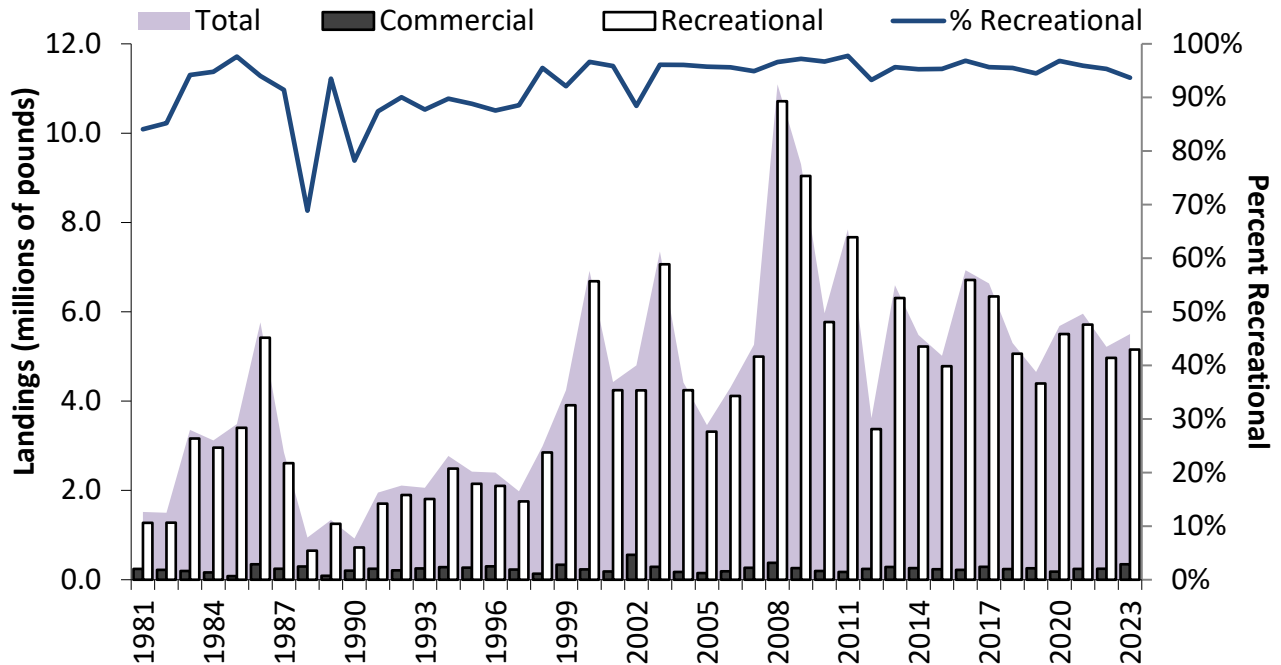


Figure 2. Commercial and recreational landings (pounds) of black drum, 1981-2023. See Tables 2 and 3 for values and data sources.

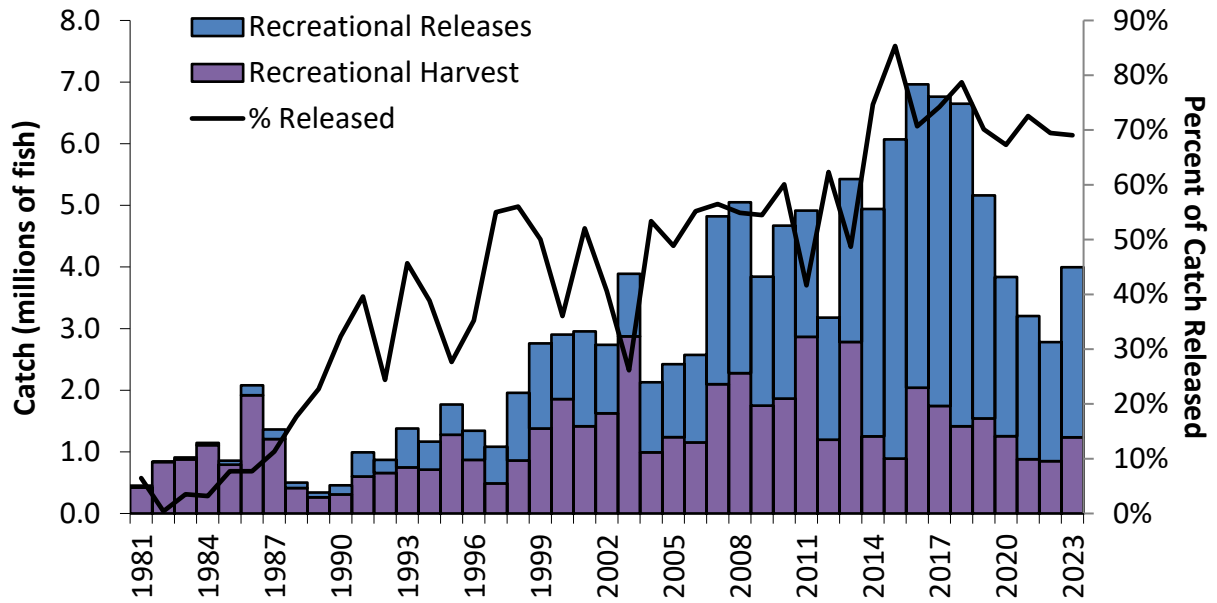


Figure 3. Recreational catch (harvest and alive releases) of black drum (numbers) and the proportion of catch that is released, 1981-2023. See Tables 4 and 5 for values and data sources.

**XI. Tables**

**Table 1. Black drum regulations for 2023.** The states of New Jersey through Florida are required to meet the requirements in the FMP. All size limits are total length.

State	Recreational		Commercial			Notes
	Size limit	Bag limit	Size limit	Trip Limit	Annual Quota	
ME - NY	-	-	-	-	-	
NJ	16" min	3/person/day	16" min	10,000 lbs	65,000 lbs	
DE	16" min	3/person/day	16" min	10,000 lbs	65,000 lbs	
MD	16" min	1/person/day 6/vessel	16" min (ATL) 28" min (Bay)	10/vessel/day (Bay)	1,500 lbs (ATL)	
PRFC	16" min	1/person/day	16" min	1 fish possession		
VA	16" min	1/person/day	16" min	1/person/day*	120,000 lbs	*without Black Drum Harvesting and Selling Permit
NC	14" min - 25" max; 1 fish > 25" may be retained	10/person/day	14" min - 25" max; 1 fish > 25" may be retained	500 lbs/trip		
SC	14" min - 27" max	5/person/day	14" min - 27" max	5/person/day		Commercial fishery primarily bycatch
GA	14" min	15/person/day	14" min	15/person/day		
FL	14" min - 24" max; 1 fish >24" may be retained	5/person/day	14" min - 24" max	500 lbs/day		

**Table 2. Commercial landings (pounds) of black drum by state, 2014-2023.** (Totals include coastwide landings outside of the management area, NJ-FL. Sources: 2024 state compliance reports for 2023 fishing year; for years prior to 2023, personal communication with ACCSP, Arlington, VA)

Year	NJ	DE	MD	PRFC	VA
2014	9,270	C	C	C	88,402
2015	6,478	39,282	C	C	87,011
2016	2,210	49,109	C	C	49,832
2017	21,248	699	423	C	42,695
2018	C	32,375	734	C	76,337
2019	C	6,030	8,025	C	129,556
2020	C	C	4,767	C	50,318
2021	1,057	C	821	0	63,340
2022	C	C	2,462	C	51,087
2023	C	C	2,097	C	71,855
	NC	SC	GA	FL	Total
2014	51,217	C	C	91,587	259,650
2015	51,073	C	C	50,477	234,727
2016	90,715	C	C	26,978	219,350
2017	182,882	C	C	41,280	289,431
2018	109,757	C	C	19,465	239,124
2019	80,036	C	C	21,954	256,051
2020	98,118	C	C	26,895	188,410
2021	131,724	C	C	45,300	243,278
2022	144,339	C	0	42,563	244,198
2023	240,814	C	0	30,486	347,506

C: Confidential landings

**Table 3. Recreational harvest (pounds) of black drum by state and coastwide average weight, 2014-2023.** (Sources: 2024 state compliance reports for 2023 fishing year; for years prior to 2023, personal communication with NOAA Fisheries, Fisheries Statistics Division)

<b>Year</b>	<b>NJ</b>	<b>DE</b>	<b>MD</b>	<b>VA</b>	<b>NC</b>
<b>2014</b>	11,476	22,070	18,684	97,043	230,834
<b>2015</b>	443,907	16,992	16,575	25,216	780,876
<b>2016</b>	159,589	2,180	8,924	77,672	1,322,547
<b>2017</b>	406,068	22,998	3,001	81,275	856,081
<b>2018</b>	814,965	179,071	53,599	29,120	428,273
<b>2019</b>	172,735	8,117	59,912	101,535	404,452
<b>2020</b>	535,249	90,950	53,825	251,724	612,932
<b>2021</b>	1,851	14,659	80,563	345,108	359,481
<b>2022</b>	190,561	1,412	19,580	18,130	1,710,528
<b>2023</b>	0	115	10,697	351,895	973,869
	<b>SC</b>	<b>GA</b>	<b>FL</b>		<b>Total</b>
<b>2014</b>	238,616	249,118	4,353,686		5,221,527
<b>2015</b>	82,484	88,698	3,325,410		4,780,158
<b>2016</b>	623,449	226,558	4,292,398		6,713,317
<b>2017</b>	681,976	187,698	4,105,686		6,344,783
<b>2018</b>	652,179	392,380	2,511,235		5,060,822
<b>2019</b>	899,976	557,714	2,191,274		4,395,715
<b>2020</b>	493,001	298,894	3,163,767		5,500,342
<b>2021</b>	345,225	178,803	4,386,989		5,712,731
<b>2022</b>	319,324	295,514	2,395,463		4,969,409
<b>2023</b>	433,013	285,898	3,097,376		5,152,863

**Table 4. Recreational harvest (numbers) of black drum by state, 2014-2023.** (Sources: 2024 state compliance reports for 2023 fishing year; for years prior to 2023, personal communication with NOAA Fisheries, Fisheries Statistics Division)

<b>Year</b>	<b>NJ</b>	<b>DE</b>	<b>MD</b>	<b>VA</b>	<b>NC</b>
<b>2014</b>	482	1,052	1,690	10,676	109,307
<b>2015</b>	10,793	462	1,091	1,600	276,126
<b>2016</b>	6,008	138	250	5,807	459,078
<b>2017</b>	18,435	1,214	828	16,700	355,544
<b>2018</b>	40,153	9,211	1,262	3,721	134,624
<b>2019</b>	7,506	931	4,897	6,600	156,401
<b>2020</b>	27,594	5,207	14,092	17,000	213,320
<b>2021</b>	382	1,115	2,724	17,607	121,454
<b>2022</b>	8,594	54	2,945	1,231	264,634
<b>2023</b>	0	7	1,202	18,587	348,374
	<b>SC</b>	<b>GA</b>	<b>FL</b>		<b>Total</b>
<b>2014</b>	96,967	47,807	983,582		1,251,563
<b>2015</b>	37,186	48,229	514,606		890,093
<b>2016</b>	256,158	96,351	1,217,913		2,041,703
<b>2017</b>	241,832	64,240	1,044,752		1,743,545
<b>2018</b>	185,648	114,263	925,794		1,414,676
<b>2019</b>	344,933	265,364	755,638		1,542,270
<b>2020</b>	198,239	100,973	678,484		1,254,909
<b>2021</b>	92,232	65,955	577,906		879,468
<b>2022</b>	92,122	111,492	367,912		849,406
<b>2023</b>	142,438	67,430	657,786		1,235,824

**Table 5. Recreational alive releases (numbers) of black drum by state, 2014-2023.** (Sources: 2024 state compliance reports for 2023 fishing year; for years prior to 2023, personal communication with NOAA Fisheries, Fisheries Statistics Division)

<b>Year</b>	<b>NJ</b>	<b>DE</b>	<b>MD</b>	<b>VA</b>	<b>NC</b>
<b>2014</b>	37,364	11,243	0	269,648	1,964,749
<b>2015</b>	545,613	17,109	25,115	164,322	1,791,758
<b>2016</b>	9,399	361	114	46,494	2,530,596
<b>2017</b>	111,739	3,689	2,809	137,987	2,336,352
<b>2018</b>	51,148	15,249	27,849	169,204	1,450,855
<b>2019</b>	1,953	29,878	6,346	151,074	756,749
<b>2020</b>	10,474	8,301	1,997	142,394	704,357
<b>2021</b>	41,807	19,517	92,542	168,208	681,121
<b>2022</b>	59,745	7,064	10,268	44,621	647,304
<b>2023</b>	18,252	29,231	3,908	71,964	591,980
	<b>SC</b>	<b>GA</b>	<b>FL</b>		<b>Total</b>
<b>2014</b>	335,600	21,581	1,047,833		3,688,018
<b>2015</b>	1,483,956	55,773	1,096,185		5,179,831
<b>2016</b>	1,268,667	54,266	1,012,670		4,922,567
<b>2017</b>	692,616	85,365	1,648,030		5,018,587
<b>2018</b>	1,087,536	167,974	2,265,550		5,235,365
<b>2019</b>	998,869	339,599	1,333,745		3,618,213
<b>2020</b>	678,836	239,371	797,425		2,583,155
<b>2021</b>	304,632	94,097	922,962		2,324,886
<b>2022</b>	647,853	168,502	345,227		1,930,584
<b>2023</b>	791,140	291,336	960,813		2,758,624

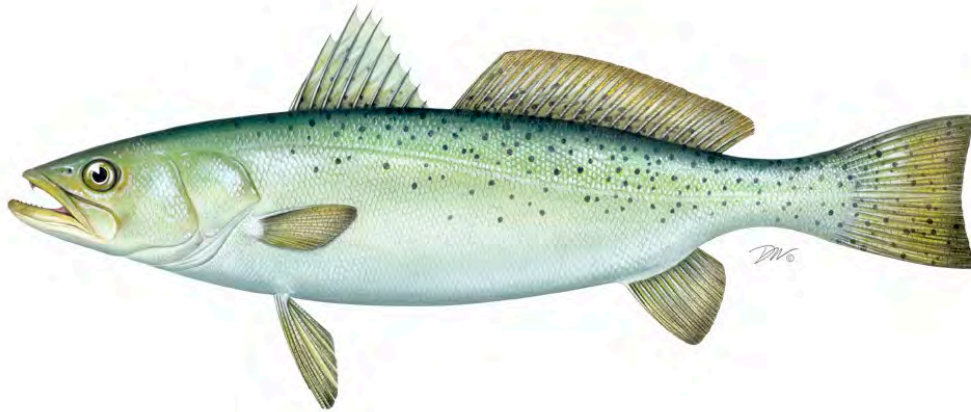


**ATLANTIC STATES MARINE FISHERIES COMMISSION**  
**REVIEW OF THE INTERSTATE FISHERY MANAGEMENT PLAN**

**FOR**

**SPOTTED SEATROUT**  
*(Cynoscion nebulosus)*

**2023 FISHING YEAR**



Prepared by the Plan Review Team  
Drafted September 2024



*Sustainable and Cooperative Management of Atlantic Coastal Fisheries*

## Table of Contents

I.	Status of the Fishery Management Plan.....	1
II.	Status of the Stock .....	2
III.	Status of the Fishery.....	3
IV.	Status of Assessment Advice .....	4
V.	Status of Research and Monitoring .....	5
VI.	Status of Management Measures and Issues .....	5
VII.	Implementation of FMP Compliance Requirements for 2023 .....	5
VIII.	Recommendations of Plan Review Team .....	5
IX.	References .....	6
X.	Figures.....	8

## I. Status of the Fishery Management Plan

<u>Date of FMP Approval:</u>	Original FMP – October 1984
<u>Amendments:</u>	Amendment 1 – November 1991 Omnibus Amendment to Spanish Mackerel, Spot, and Spotted Seatrout -- August 2011
<u>Management Area:</u>	The Atlantic coast distribution of the resource from Maryland through the east coast of Florida
<u>Active Boards/Committees:</u>	Sciaenids Management Board; Spotted Seatrout Plan Review Team; South Atlantic Species Advisory Panel

The Atlantic States Marine Fisheries Commission (ASMFC) adopted the [Fishery Management Plan \(FMP\)](#) for spotted seatrout in 1984. The ISFMP Policy Board approved Amendment 1 to the FMP in November 1991. In August 2011, the South Atlantic State/Federal Management Board approved the Omnibus Amendment to the Spanish Mackerel, Spot, and Spotted Seatrout FMPs, bringing the Spotted Seatrout FMP under the authority of the Atlantic Coastal Fisheries Cooperative Management Act (Act, 1993) and the ASMFC Interstate Fishery Management Plan Charter (1995). The management unit is comprised of the states of Maryland through Florida.

The goal of the management plan is "to perpetuate the spotted seatrout resource in fishable abundance throughout its range and generate the greatest possible economic and social benefits from its harvest and utilization over time." Plan objectives include:

1. Attain optimum yield over time.
2. Maintain a spawning potential ratio of at least 20% to minimize the possibility of recruitment failure.
3. Promote conservation of the stocks to reduce inter-annual variation in availability and to increase yield per recruit.
4. Promote collection of economic, social, and biological data required to effectively monitor and assess management efforts relative to the overall goal.
5. Promote research that improves understanding of the biology and fisheries of spotted seatrout.
6. Promote harmonious use of the resource among various components of the fishery through coordination of management efforts among the various political entities having jurisdiction over the spotted seatrout resource.
7. Promote determination and adoption of standards of environmental quality and provide habitat protection necessary for the maximum natural protection of spotted seatrout.

The [Omnibus Amendment](#) added the following objectives to support compliance under the Act:

1. Manage the spotted seatrout fishery by restricting catch to mature individuals.
2. Manage the spotted seatrout stock to maintain sufficiently high spawning stock biomass.
3. Develop research priorities that will further refine the spotted seatrout management program to maximize the biological, social, and economic benefits derived from the population.

Management measures include a minimum size limit of 12 inches in total length (TL), with comparable mesh size regulations in directed fisheries, and data collection for stock assessments and monitoring of the fishery. All states with a declared interest in spotted seatrout (NJ-FL) have implemented, at a minimum, the recommended minimum size limit. In addition, each state has either initiated spotted seatrout data collection programs or modified other programs to collect improved catch and effort data. Table 1 provides the states' recreational and commercial regulations for spotted seatrout in 2023.

## **II. Status of the Stock**

A coastwide stock assessment of spotted seatrout has not been conducted, given the largely non-migratory nature of the species and the lack of data on migration where it does occur. Instead, state-specific age-structured analyses of local stocks have been performed by several states. These stock assessments provide estimates of static spawning potential ratio (SPR), a measure of the effect of fishing pressure on the relative spawning power of the female stock. The FMP recommends a goal of 20% SPR. South Carolina and Georgia have adopted this goal while North Carolina and Florida have established a 30% and 35% SPR goal, respectively.

A benchmark stock assessment for spotted seatrout in North Carolina and Virginia waters was completed and approved to use for management in late 2022 (<https://www.deq.nc.gov/marine-fisheries/fisheries-management/spotted-seatrout/2022-spotted-seatrout-stock-assessment/open>; NCDMF 2022). The assessment indicated the spotted seatrout stock in North Carolina and Virginia waters was not overfished with spawning stock biomass (SSB) above  $SSB_{35\%}$ , but overfishing was occurring. A review of the North Carolina FMP is currently underway. Amendment 1 to the North Carolina Spotted Seatrout FMP will focus on management to end overfishing and ensure sustainable harvest.

The South Carolina Department of Natural Resources packaged several state-specific assessments into a report in 2001, though these were not peer reviewed. The initial assessment covering 1986-1992 indicated female SPR was just above the 20% goal in the terminal year (Zhao and Wenner 2001), leading to a minimum size limit increase and a creel limit reduction. A more recent assessment was conducted for the period 1981-2004 (de Silva, Draft 2005). Two modeling approaches were used, and both models indicated the current SSB is below the requirement to maintain 20% SPR.

Florida completed a new statewide assessment in 2018, which in 2019 was updated with data through 2017 (<https://myfwc.com/media/26731/seatrout-assessment-summary-2019.pdf>;

Addis et al. 2018; Muller and Addis 2019). They assessed the status of spotted seatrout populations among management regions in Florida waters using an integrated statistical catch-at-age model, Stock Synthesis, as the primary modeling platform. Spotted seatrout population dynamics were described for the period 1950-2017 utilizing available information on catch, effort, relative abundance, and size/age composition. For the Northeast (Nassau through Flagler counties) and Southeast (Volusia through Miami-Dade counties) management regions along Florida's Atlantic coast, the regional base SS model estimates of current transitional spawning potential ratios ( $tSPR_{Current}$ , geometric mean for 2015-2017) are 31% in the northeast, and 34% in the southeast region. The  $tSPR_{Current}$  values for the two Atlantic coast regions were found to be below the Commission's 35%  $tSPR_{Current}$  management target. These assessment results led to changes in spotted seatrout regulations in Florida, including decreasing bag limits and modifying the slot size limit (Table 1). Work on a new benchmark stock assessment is underway in Florida, and is scheduled to be completed in by the end of 2024.

### **III. Status of the Fishery**

Spotted seatrout are typically caught both commercially and recreationally from Delaware through the east coast of Florida. In South Carolina, spotted seatrout are declared a gamefish and can only be taken by recreational means. Landings from states north of Delaware are minimal and/or inconsistent from year to year. In 2023, landings ranged as far north as Connecticut. State catch estimates in this section include those in the management area only (NJ-FL), but coastwide totals include the entire Atlantic coast. Total recreational landings have surpassed total commercial landings every year since recreational landings were first recorded in 1981 (Figure 1). Spotted seatrout, particularly those found from Virginia through South Carolina, are susceptible to cold stuns that result in sporadic, high winter mortality, which can lead to sudden declines in harvest. The last cold stun occurred in 2018, prompting in-season changes to management in affected states.

#### *Commercial Fishery*

Commercial harvest statistics were obtained from the Atlantic Coastal Cooperative Statistics Program (ACCSP) for years prior to 2023 and from state compliance reports for 2023. Atlantic coast commercial landings (1950-2023) range from 157,000 pounds in 2011 to 2.3 million pounds in 1952 (Figure 1). Historically, commercial landings primarily came from Virginia, North Carolina, and Florida, with Maryland, South Carolina, Georgia, and occasional landings from Delaware and north accounting for a small portion. From 1950 to 1976, annual commercial landings averaged 1.3 million pounds, followed by a decline due to increased regulations and possible declines in abundance. Significant changes to regulations include the 1987 designation of spotted seatrout as a gamefish in South Carolina, and the 1995 prohibition on the use of entangling nets in Florida's coastal waters. From 2014 to 2023, commercial landings averaged approximately 453,178 pounds. In 2023, commercial landings totaled 522,290 pounds, a 31% decrease from a peak in 2021 (Table 2). North Carolina, Virginia, and Florida accounted for 83%, 14%, and 2% of the total commercial landings, respectively.

### *Recreational Fishery*

Recreational harvest statistics were obtained from the Marine Recreational Information Program (MRIP) for years prior to 2023 and from state compliance reports for 2023. Over the last 41 years, recreational catch of spotted seatrout (kept and released) has shown an upward trend, increasing from 4.3 million fish in 1981 to 31.2 million fish in 2018 and had remained high through 2022. In 2023, recreational catch declined by 37% from the previous year, to 16.2 million fish, the lowest recreational catch since 2008 (Figure 2). Recreational harvest has remained without trend throughout the time series. From 2019 through 2022, recreational harvest was relatively high, averaging 6.6 million pounds or 3.9 million fish. However, recreational harvest in 2023 declined by approximately 40% from this average, to 4.3 million pounds or 2.4 million fish (Tables 3 and 4), with North Carolina (41%), Georgia (20%), and Virginia (17%) responsible for the largest shares in numbers of fish. Due in part to recreational size and creel limits and closed seasons, as well as the encouragement of catch and release practices, the percentage of caught fish being released has increased throughout the time series, with the 10-year average (2014-2023) at 82%. The percent of fish released in 2023 (85%) was approximately equal to the percent of fish released in 2022 (85%; Figure 2, Table 5). The number of fish released has averaged 18.9 million fish in the last 10 years (2014-2023). In 2023, 13.7 million fish were released, which was a 38% decline from the previous year. Rod and reel is the primary recreational gear, but some spotted seatrout are taken by recreational nets and gigging where these methods are permitted. Most recreational fishing is conducted from private boats and the majority of the catch is taken from nearshore waters.

#### **IV. Status of Assessment Advice**

A coastwide stock assessment of spotted seatrout has not been conducted and the Plan Review Team (PRT) does not recommend that one be completed due to the life history of the fish and the availability of data. Several states have performed age-structured analyses on local stocks, and recent assessments provide divergent trends on the status of the species. The 2005 stock assessment in South Carolina indicated an increasing population trend but a status level that is still below target spawning stock biomass levels (de Silva 2005).

The 2022 North Carolina and Virginia stock assessment indicated overfishing was occurring but that the stock was not overfished (NCDMF 2022). The stock assessment model was a novel, size structured model with winter and non-winter seasonal time-steps. Additionally, the model allowed winter natural mortality (M) to vary year to year in order to capture the signature of increased winter M from cold stuns and predicted high or rising M in most years with documented cold stuns.

In the 2019 Florida stock assessment update, the regional base SS model estimated current transitional spawning potential ratios of 31% in the Northeast management region, and 34% in the Southeast management region on Florida's Atlantic coast. The transitional spawning potential ratio for the spotted seatrout stock in northeast Florida was below the Commission's 35%  $tSPR_{Current}$  management target and in southeast Florida, it was just below or at the management target (Muller and Addis 2019).

The PRT supports the continuation of state-specific assessments, yet recognizes the difficulty most states face to attain sufficient data of assessment quality and personnel who can perform the necessary modeling exercises. The lack of biological and fisheries data for effective assessment and management of the resource was recognized in the 1984 FMP and continues to be a hindrance. Some states are increasing their collection of biological and fisheries data, which will provide insight on stock status over time.

## **V. Status of Research and Monitoring**

In addition to commercial and recreational fishery-dependent data collected and/or compiled through the NMFS Fisheries Statistics Division, some states have implemented fishery-independent or additional fishery-dependent monitoring programs. States currently conducting fishery dependent sampling include Delaware, Maryland, Virginia, North Carolina, South Carolina, Georgia, and Florida. Delaware, Maryland, North Carolina, South Carolina, Georgia, and Florida currently conduct fishery independent surveys for spotted seatrout or run surveys encountering spotted seatrout. Virginia, North Carolina, and South Carolina conduct aging, and in 2023 the NCDMF aging lab aged a total of 1,045 spotted seatrout by otoliths with a maximum age of 8 and a modal age of 1. In 2023, Virginia aged 259 spotted seatrout, with a modal age of 1.

## **VI. Status of Management Measures and Issues**

### ***De Minimis Requests***

A state qualifies for *de minimis* status if its previous three-year average combined commercial and recreational catch is less than 1% of the previous three-year average coastwide combined commercial and recreational catch. Those states that qualify for *de minimis* are not required to implement any monitoring requirements, as none are included in the plan.

The states of Delaware and New Jersey request continuation of *de minimis* status, and the PRT notes they meet the requirements of *de minimis*.

## **VII. Implementation of FMP Compliance Requirements for 2023**

The PRT found no inconsistencies in relation to the FMP compliance requirements among state compliance reports.

## **VIII. Recommendations of Plan Review Team**

### Management and Regulatory Recommendations

- Consider approval of *de minimis* requests by New Jersey and Delaware.

### Prioritized Research Recommendations

- The PRT recommends focusing on addressing important missing components to improve state specific stock assessments. Specific focal areas include the development or

improvement of state specific abundance indices, particularly for juvenile abundance indices, research into fecundity and recruitment relationships, and additional research into B2 releases due to a rise in popularity of the catch and release fishery.

- Consider trigger factors to allow for a swift management response to environmental events that have been shown to heavily impact spotted seatrout. An example is a temperature trigger in North Carolina to protect spotted seatrout that have had long-term exposure to cold temperatures. Additional research into links between spotted seatrout population dynamics and life history variability in response to environmental factors such as land use patterns, climate change, etc.

## **IX. References**

- De Silva JA. 2005. Draft. Stock assessment of spotted seatrout, *Cynoscion nebulosus*, in South Carolina with recommendations on the management of the recreational fishery. South Carolina Department of Natural Resources, Marine Research Institute, Charleston (SC).
- Florida Fish and Wildlife Conservation Commission's Fish and Wildlife Research Institute. 2013. Species Profile: Spotted Seatrout. In: R.H. McMichael, editor. Fisheries-independent monitoring program, 2012 annual data summary report, St. Petersburg (FL).
- Addis D, Mahmoudi B, O'Hop J, Muller R. 2018. The 2016 stock assessment of Spotted Seatrout, *Cynoscion nebulosus*, in Florida. Florida Fish and Wildlife Conservation Commission's Fish and Wildlife Research Institute, St. Petersburg, (FL).
- Jensen CC. 2009. Stock status of spotted seatrout, *Cynoscion nebulosus*, in North Carolina, 1991-2008. Morehead City (NC): North Carolina Division of Marine Fisheries. 89 p.
- Moravec F, de Buron I, Roumillat WA. 2006. Two new species of Philometra (Nematoda: Philometridae) parasitic in the perciform fish *Cynoscion nebulosus* (Sciaenidae) in the estuaries of South Carolina, USA. *Folia Parasitologica*, 53: 63-70
- Muller, R, and Addis D. 2019. An update assessment of the status of spotted seatrout in Florida waters through 2017. Florida Fish and Wildlife Conservation Commission's Fish and Wildlife Research Institute, St. Petersburg, (FL).
- Murphy MD, Chagaris D, Addis D. 2011. An assessment of the status of spotted seatrout in Florida waters through 2009. Florida Fish and Wildlife Conservation Commission Fish and Wildlife Research Institute. In-House Report 2011-002, St. Petersburg (FL).
- North Carolina Division of Marine Fisheries. 2014. Stock assessment of spotted seatrout, *Cynoscion nebulosus*, in Virginia and North Carolina waters. North Carolina Department of Environment and Natural Resources, Division of Marine Fisheries, Morehead City (NC).



North Carolina Division of Marine Fisheries. 2022. Stock Assessment of Spotted Seatrout, *Cynoscion nebulosus*, in Virginia and North Carolina waters, 1991–2019. North Carolina Division of Marine Fisheries, NCDMF SAP-SAR-2022-02, Morehead City, North Carolina. 137

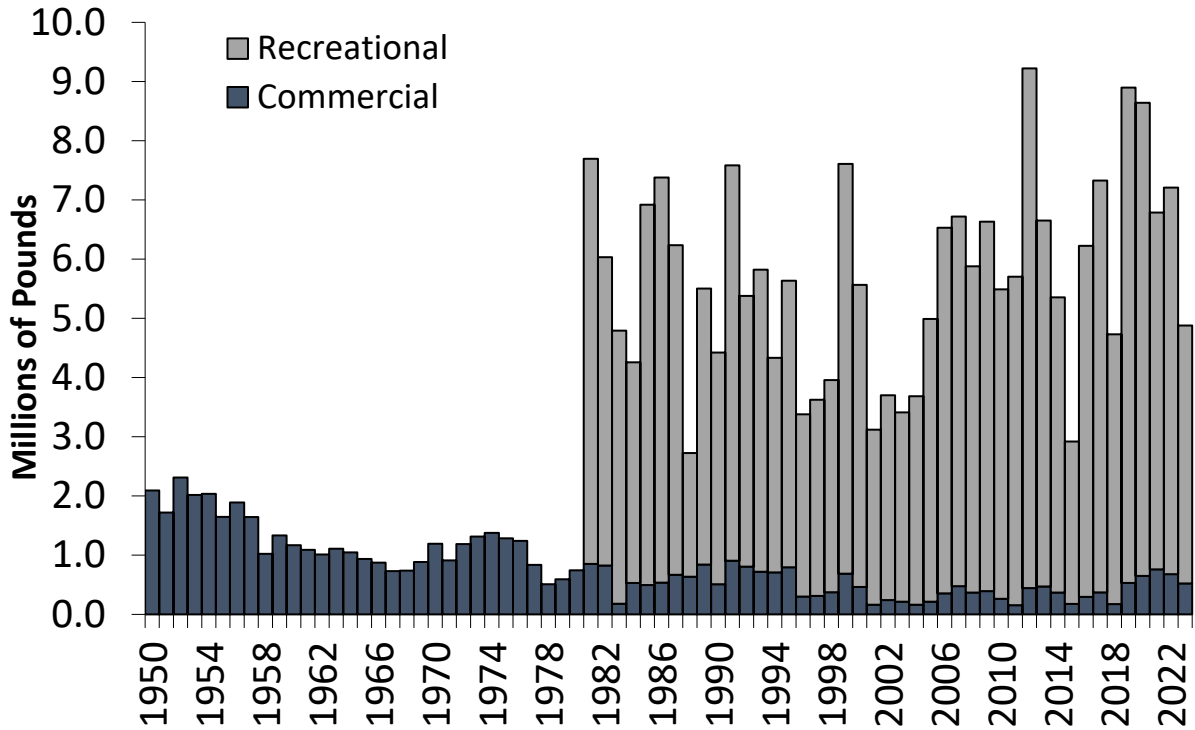
Roumillat WA, Brouwer MC. 2004. Reproductive dynamics of female spotted seatrout (*Cynoscion nebulosus*) in South Carolina. Fisheries Bulletin, 102: 473-487

Zhao B, Burns B. 2001. Stock assessment of the spotted seatrout, *Cynoscion nebulosus*, on the North Carolina coast, 1981-1997. In: South Carolina Department of Natural Resources. Cooperative Research on the Biology and Assessment of Nearshore and Estuarine Fishes along the Southeast Coast of the U.S: Part III. Spotted Seatrout, *Cynoscion nebulosus*. Charleston (SC): SC DNR. Final Report, Grant NA77FF0550.

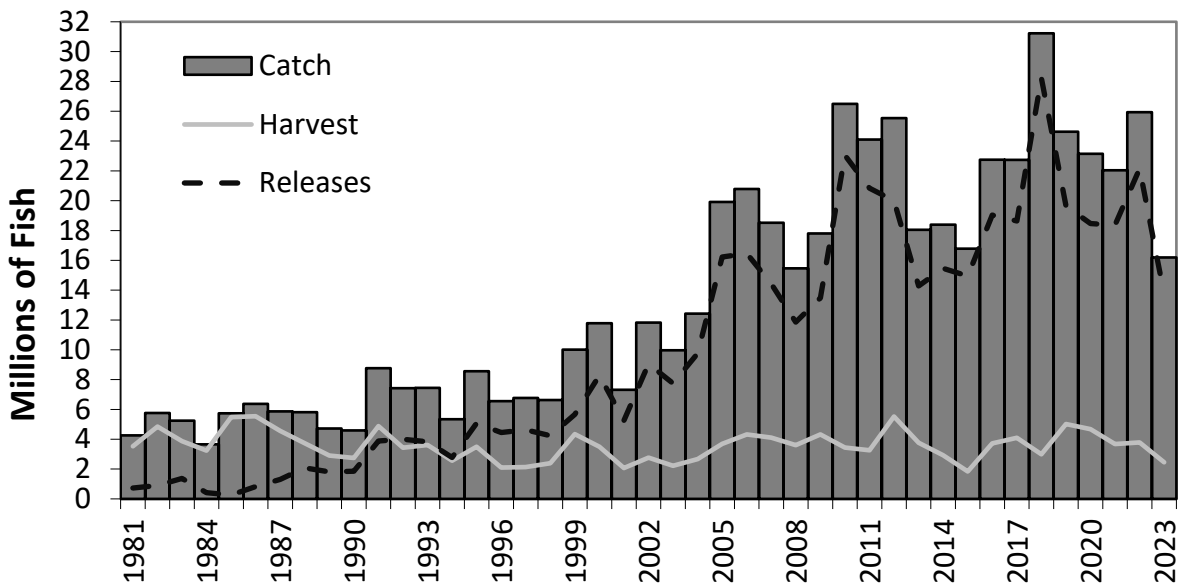
Zhao B, Wenner C. 2001. Stock assessment of the spotted seatrout, *Cynoscion nebulosus*, on the South Carolina coast, 1986-1992. In: South Carolina Department of Natural Resources. Cooperative Research on the Biology and Assessment of Nearshore and Estuarine Fishes along the Southeast Coast of the U.S: Part III. Spotted Seatrout, *Cynoscion nebulosus*. Charleston (SC): SC DNR. Final Report, Grant NA77FF0550.

Zhao B, Wenner C, Nicholson N. 2001. Stock assessment of the spotted seatrout, *Cynoscion nebulosus*, on the Georgia Coast, 1986-1995. In: South Carolina Department of Natural Resources. Cooperative Research on the Biology and Assessment of Nearshore and Estuarine Fishes along the Southeast Coast of the U.S: Part III. Spotted Seatrout, *Cynoscion nebulosus*. Charleston (SC): SC DNR. Final Report, Grant NA77FF0550.

X. Figures



**Figure 1.** Coastwide commercial landings (1950-2023) and recreational landings (1981-2023), in pounds (See Tables 2 and 4 for values and sources). Recreational data not available prior to 1981.



**Figure 2.** Coastwide recreational catch, harvest, and releases (numbers), 1981-2023 (See Tables 3 and 5 for values and sources).

## XI. Tables

**Table 1.** Summary of state regulations for spotted seatrout in 2023.

State	Recreational	Commercial
New Jersey	13" TL; 1 fish	13" TL; 100 lbs/vessel/day during open seasons 100 lbs bycatch allowance during closed season if equal lbs of other species are also harvested.  Gill net: 3.25 in minimum mesh size; closed season from 5/21-9/2 and 10/20-10/26.  Otter trawl: 3.75 in minimum diamond stretched mesh size or 3.375 in stretched square mesh; closed season 8/1 to 10/12  Pound net: closed season 6/7 to 6/30  Hook and line: must follow recreational bag and size limit
Delaware	12" TL	12" TL
Maryland	14" TL; 4 fish	14" TL. 150 lbs limit per day or trip (whichever is longer). Trawl and gill net mesh size restrictions.
PRFC	14" TL; 10 fish	14" TL
Virginia	14-24" TL; 1 fish >24" allowed; 5 fish	14" TL; pound nets/seines allowed 5% by weight less than 14".  Hook & line fishermen must follow rec limits.  Quota: 51,104 lbs (Sept-Aug). After it's been announced the quota has been reached, then daily incidental catch of 50 lbs/licensee aboard the vessel, not to exceed 100 lbs per vessel
North Carolina	14" TL; 4 fish	14" TL; 75 fish limit. Unlawful to possess or sell Friday 12:00am-Sunday 12:00am.
South Carolina	14" TL; 10 fish. Gig March-Nov.	Gamefish status since 1987; native caught fish may not be sold.
Georgia	14" TL; 15 fish	14" TL; 15 fish. BRD requirement for trawl; gear mesh regulations.
Florida	15-19" TL slot; 1 fish >19" allowed per vessel, or per person if fishing on land; 0 captain and crew bag limit on for-hire trip; hook & line/cast net only. Western Panhandle: 3 fish, closed February; Big Bend: 5 fish; South: 3 fish; Central East: 2 fish, closed Nov -Dec; Northeast: 5 fish	Hook & line/cast net only; 15-24" TL; Season varies by region; 50 fish per person per day or 100 fish vessel limit with two or more licensed fishermen on board South, Big Bend, and Western Panhandle: Open June 1 - October 31. Central East: Open May 1 - September 30. Northeast: Open June 1 - November 30.

Note: A commercial fishing license is required to possess spotted seatrout for sale in all states with a fishery.

**Table 2.** Commercial landings (pounds) of spotted seatrout by state, 2014-2023 (Source: ACCSP for years prior to 2023 and State Compliance Reports for 2023). Totals are for the coastwide fishery and may extend beyond the management unit. "C" represents confidential data.

Year	NJ	DE	MD	VA	NC	SC	GA	FL	Total
2014			C	90,051	242,245	C	C	37,710	370,110
2015			C	7,888	128,752	C	C	39,226	175,931
2016			C	18,483	254,590	C	C	23,105	296,419
2017			C	55,219	299,910	C	C	16,194	371,590
2018			C	17,526	128,980	C	C	22,105	173,651
2019			C	100,763	378,491	C	C	16,700	531,010
2020		C	C	67,794	568,764	C	C	12,591	650,034
2021			C	51,594	694,784	C	C	12,352	760,690
2022	C		72	68,479	603,155	C	C	5,696	679,576
2023	133	0	1,596	70,913	434,610	0	0	10,732	522,290

**Table 3.** Recreational harvest (A + B1; numbers of fish) of spotted seatrout using the FES effort calibration, by state, 2014-2023 (Source: MRIP). Totals are for the coastwide fishery and may extend beyond the management unit.

Year	NJ	DE	MD	VA	NC	SC	GA	FL	Total
2014		3,514	21,560	84,537	725,086	260,321	724,411	1,111,177	2,930,606
2015		39	11,619	23,062	249,260	311,106	740,932	504,137	1,840,155
2016	547	12	10,092	163,529	978,624	311,168	1,290,220	962,946	3,717,042
2017			24,255	172,288	1,217,834	647,679	1,060,493	977,797	4,100,346
2018		344		189,537	449,473	175,191	1,096,602	929,155	2,993,485
2019		4,644	36,314	596,428	1,937,250	813,548	1,008,284	620,337	5,016,805
2020		774	11,951	591,624	2,053,354	511,261	830,771	678,934	4,678,669
2021			17,664	399,529	1,223,508	483,046	935,052	621,389	3,680,188
2022			8,739	248,150	1,963,400	281,274	952,260	337,142	3,790,965
2023			21,533	410,505	1,002,906	304,452	497,679	222,214	2,459,289

**Table 4.** Recreational harvest (A + B1; pounds of fish) of spotted seatrout using the FES effort calibration, by state, 2014-2023 (Source: MRIP). Totals are for the coastwide fishery and may extend beyond the management unit.

Year	NJ	DE	MD	VA	NC	SC	GA	FL	Total
2014		6,295	46,870	166,182	1,451,592	382,155	825,903	2,111,818	4,984,520
2015		10	23,546	48,477	430,579	462,498	794,861	984,940	2,744,901
2016	451	8	20,024	341,977	1,724,492	475,749	1,740,513	1,625,597	5,928,352
2017			48,624	342,463	2,157,198	992,938	1,403,646	2,011,777	6,956,646
2018		248		226,786	658,555	414,442	1,556,782	1,701,275	4,557,840
2019		10,878	61,935	1,256,916	3,334,163	1,238,834	1,440,368	1,033,847	8,366,063
2020		790	28,170	1,375,062	3,632,315	713,197	1,196,591	1,045,536	7,990,871
2021			40,801	815,724	2,241,421	696,038	1,277,168	956,682	6,027,834
2022			12,902	549,095	3,756,040	423,318	1,268,493	519,335	6,529,183
2023			47,091	938,451	1,923,165	463,895	669,434	313,986	4,356,022

**Table 5.** Recreational releases (number of fish) of spotted seatrout using the FES effort calibration, by state, 2014-2023 (Source: MRIP). Totals are for the coastwide fishery and may extend beyond the management unit.

Year	NJ	DE	MD	VA	NC	SC	GA	FL	Total
2014		2,926	74,250	1,059,287	3,949,284	1,407,310	1,687,540	7,279,660	15,460,257
2015		604	242,150	834,028	4,824,088	1,147,982	1,763,638	6,131,007	14,943,497
2016	15,423	15,066	133,223	3,708,969	6,475,193	1,791,072	2,113,253	4,783,644	19,035,843
2017	0	71	107,611	3,154,997	5,147,567	1,949,554	2,436,867	5,845,559	18,641,985
2018	418		54,795	4,455,420	15,245,249	1,062,769	2,022,125	5,306,034	28,230,566
2019	2,262	5,905	334,805	2,865,887	7,161,183	2,476,659	2,673,432	4,098,551	19,643,063
2020		9,027	237,023	2,830,854	6,155,571	1,301,634	2,632,036	5,306,269	18,471,640
2021			84,300	3,035,971	6,284,614	1,467,051	3,022,516	4,467,598	18,362,050
2022			97,241	2,291,186	10,860,575	1,189,063	2,039,833	5,667,898	22,145,796
2023		19,472	49,493	3,557,195	4,566,788	1,068,702	1,644,289	2,825,335	13,731,274